

# ORTHOPAEDIC SURGICAL INSTRUMENTS

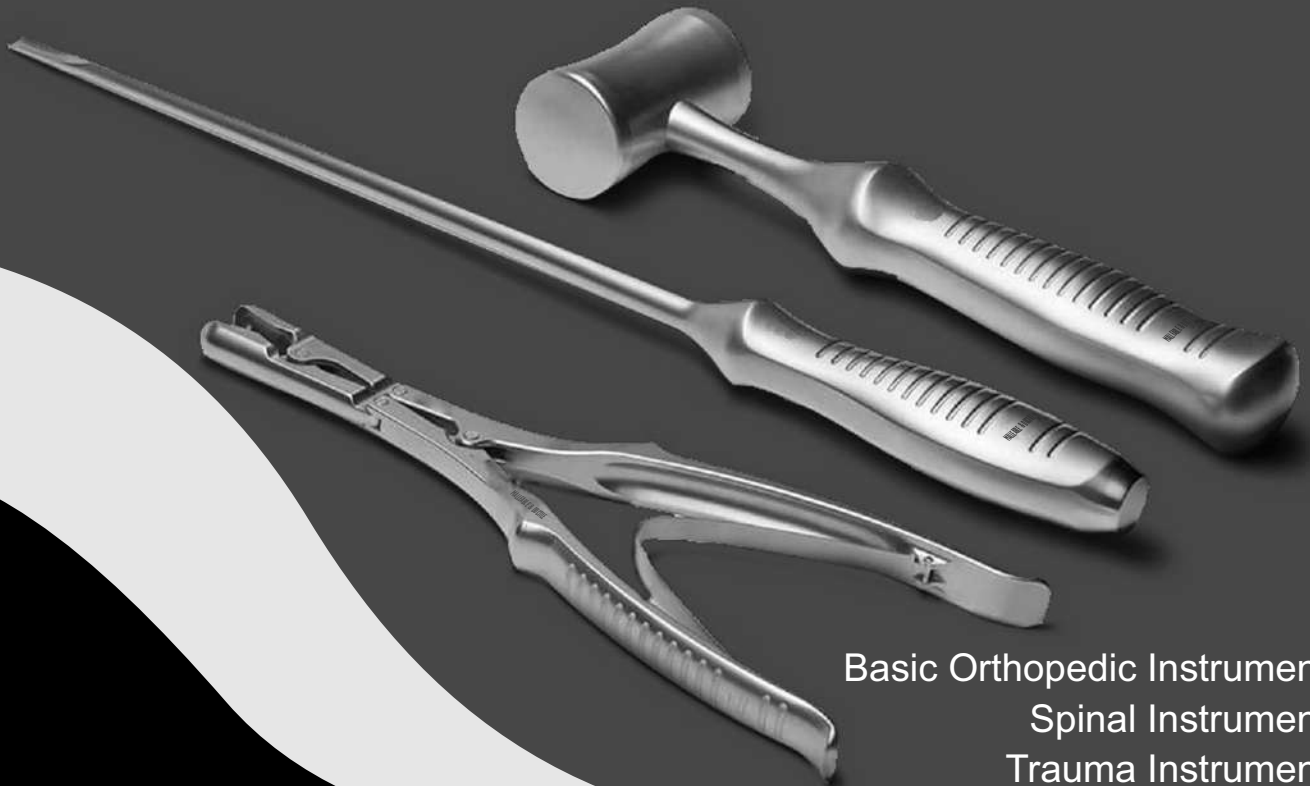

- Basic Orthopedic Instruments ■
- Spinal Instruments ■
- Trauma Instruments ■



**MALLEABLE & DUCTILE**  
INSTRUMENTS



## INDEX

<u>PARTICULARS</u>	<u>PAGE</u>
1) ORTHOPEDIC DRESSING – PLASTER INSTRUMENTS	03-05
2) AMPUTATION SAW – GIGLI SAW	06-07
3) REAMERS – AWLS – BONE HOOKS	08-09
4) ORTHOPEDIC HAND BONE DRILLS & ACCESSORIES	10-13
5) BONE HOLDING CLAMPS – TRACTION BARS	14-15
6) VISE GRIPS – NOSE PLIERS – SLAP HAMMERS	16-17
7) NOSE PLIERS – PULLING FORCEPS – WIRE CUTTERS	18-20
8) PLIERS – BENDERS – ROD INSTRUMENTS	21-22
9) WIRE INSTRUMENTS – EXTENSION BOWS	23-25
10) RING CUTTERS – LEAD HANDS – BIPOSY TOOLS	26-27
11) BONE TEMPERS – IMPACTORS - PACKERS	28
12) BONE RASPS – FILES	29-32
13) BONE LEVERS – RETRACTORS	33-39
14) CHISELS – OSTEOTOMES – GOUGES	40-45
15) BONE CURETTES	46-51
16) PERIOSTEAL ELEVATORS – DISSECTORS	52-56
17) ORTHOPEDIC MALLETS & ELEVATORS SPINAL S/S & FIBRE	57-60
18) TENDON INSTRUMENTS	61-63
19) PELVIC REDUCTION FORCEPS	64-65
20) BONE HOLDING FORCEPS	66-73
21) REPOSITION – CARTILAGE FORCEPS	74
22) BONE CUTTING FORCEPS	75-78
23) BONE RONGEURS – NIBBLERS	79-88
24) RIB SHEARS	89-91
25) LAMINA SPREADERS – RETRACTORS	92-93
26) CALCANEAL LAMBARDI SPREADERS	94
27) COMPRESSORS - DISTRACTORS	95-96
28) ROD BENDERS	97
29) CARBIDE WIRE – PIN CUTTING PLIERS	98-101
30) CARBIDE INSERTED SURGICAL SCISSORS	102-103
31) INSTRUMENTS FOR TRUATOMY	104-116

## ORTHOPEDIC DRESSING – PLASTER INSTRUMENTS

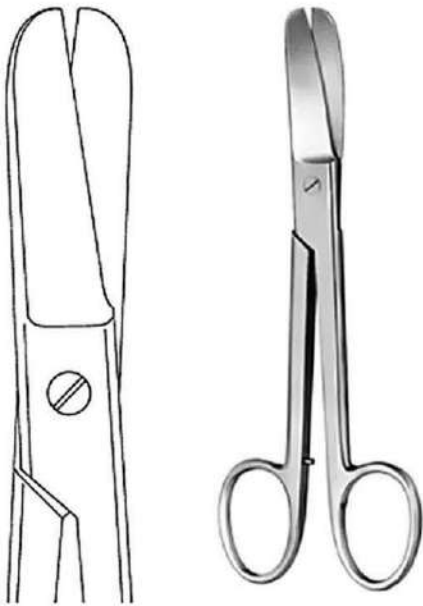

**MD-11-01-0300**  
Lorenz Bandage Scissors  
Heavy Pattern 23 cm / 9"

Also available  
in 18.5 cm / 7 1/4"  
& 20 cm / 8"

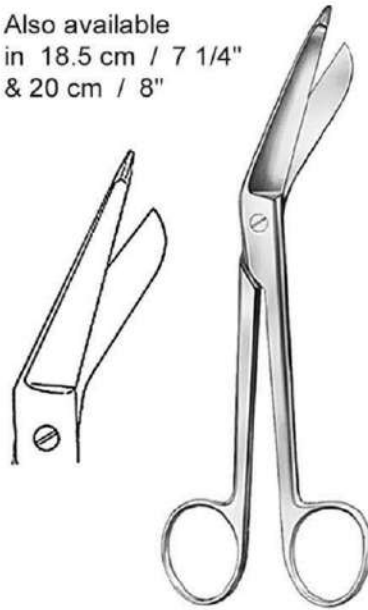

**MD-11-01-0301**  
Lister Bandage Scissors  
14.5 cm / 5 3/4"

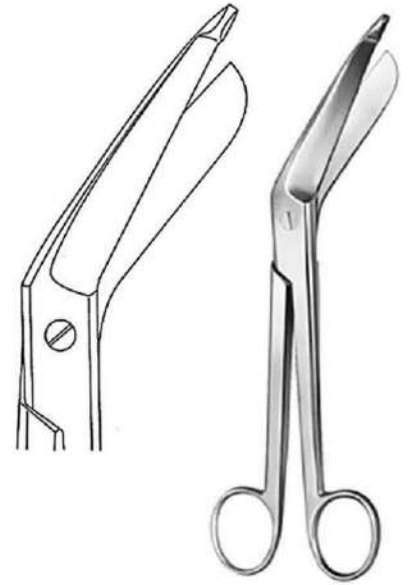

**MD-11-01-0302**  
Bergmann Plaster Shears  
Heavy Pattern 23.5 cm / 9"



**MD-11-01-0303**  
Esmarch Plaster Shears  
Heavy Pattern, Short Blades  
20 cm / 8"

Also available  
in 18cm / 7 1/2"



**MD-11-01-0304**  
Bandage Scissors  
16cm / 6 1/4" Black Plastic Rings

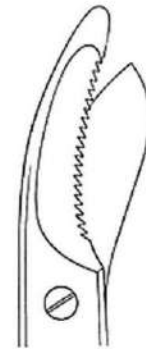

**MD-11-01-0305**  
Bruns Plaster Scissors 24 cm  
9 1/2" One Serrated Cutting Edge

## ORTHOPEDIC DRESSING – PLASTER INSTRUMENTS



Also Available  
26 cm / 10"  
38 cm / 15"

**MD-11-01-0306**

Stille-Martin Plaster Shears  
23 cm / 9"



**MD-11-01-0307**

Engel Plaster Saw 15.5 cm / 6"



**MD-11-01-0308**

Engel Plaster Saw 15.5 cm / 6"



**MD-11-01-0308**

Bergmann Plaster Saw 18 cm / 7"



**MD-11-01-0309** Reiner Plaster Knife 18 cm / 7"



**MD-11-01-0311** Hopkins Plaster Knife 20 cm / 8"



**MD-11-01-0310** Esmarch Plaster Knife 18 cm / 7"



with wooden handle

**MD-11-01-0312** Martin Plaster Knife 21 cm / 8 ¼"

## ORTHOPEDIC DRESSING – PLASTER INSTRUMENTS

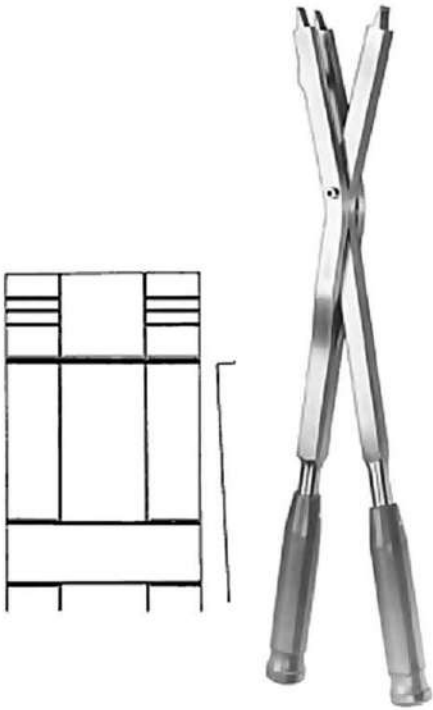

**MD-11-01-0313**

Hermann Plaster Spreader  
48 cm / 19" Heavy Pattern



**MD-11-01-0314**

Hennig Plaster Spreader  
28 cm / 11"



**MD-11-01-0315**

Hennig Plaster Spreader  
30 cm / 12"



**MD-11-01-0316** Beeson Plaster Spreader 1.5 in Blade 30 cm / 12"

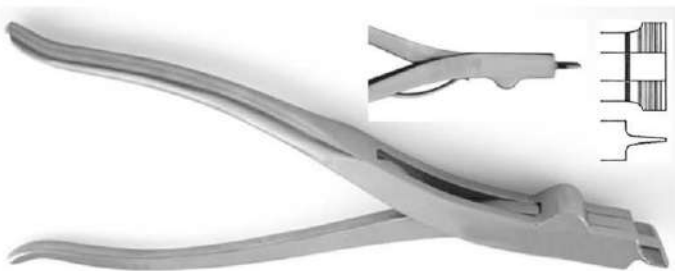

**MD-11-01-0317** Walton Plaster Spreader w/Spring 3 Prongs 23 cm / 9"

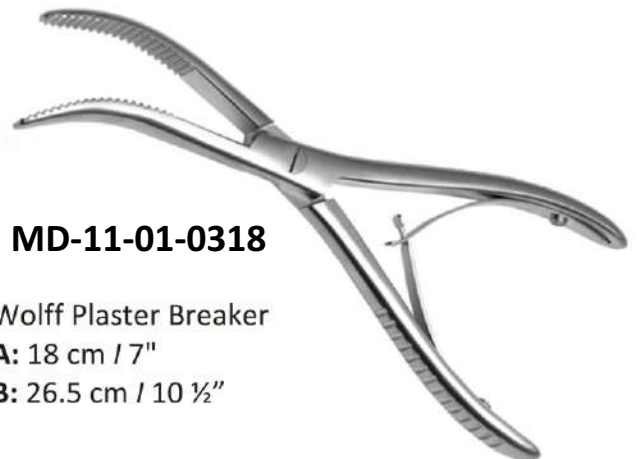

**MD-11-01-0318**

Wolff Plaster Breaker  
**A:** 18 cm / 7"  
**B:** 26.5 cm / 10 ½"

## AMPUTATION SAW – GIGLI SAW

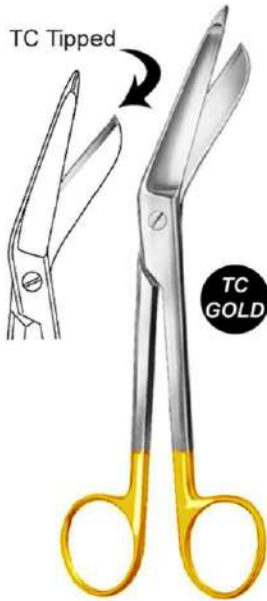

**MD-11-01-0319**

Lister Bandage Scissors TC  
18 cm / 7" cm / 13 3/4"



**MD-11-01-0320**

Bruns Plaster Scissors  
24 cm / 9 1/2"



**MD-11-01-0321**

Charriere Amputation Saw 35 cm / 13 3/4"



**A:** 21.5 cm / 8 3/4" 12mm



**B:** 21.5 cm / 8 3/4" 15mm



**C:** 21.5 cm / 8 3/4" 18mm

Spare Saw Blades



**MD-11-01-0322**

BIER Amputation Saw 40.5 cm / 16"



**A:** 27 cm / 10 3/4" 4 mm wide



**B:** 27 cm / 10 3/4" 6 mm wide



**C:** 27 cm / 10 3/4" 8 mm wide



**MD-11-01-0323**

Langenbeck Amputation Saw 24.5 cm / 9 3/4"



**MD-11-01-0324** Satterlee Amputation Saw

29 cm / 11 1/2"



**MD-11-01-0325** Charriere Amputation Saw 27 cm / 10 1/2"



**MD-11-01-0326** Satterlee Amputation Saw 23 cm / 9"

## AMPUTATION SAW – GIGLI SAW

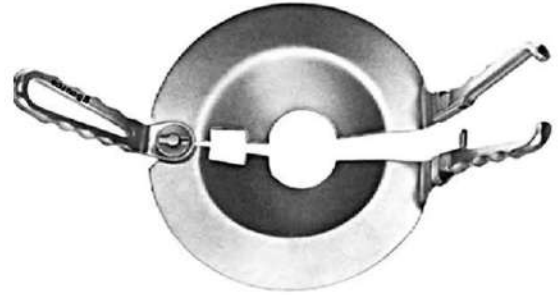
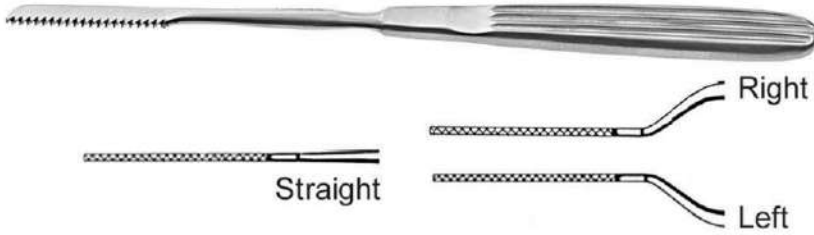

**MD-11-01-0327** oseph Amputation Saw 18 cm / 7"

**MD-11-01-0328**

Percy Amputation Shield 30 cm / 12"



**MD-11-01-000**

- A:** Gigli Saw 30cm
- B:** Gigli Saw 50cm
- C:** Tyler Gigli Saw (Large Cut) 30cm
- D:** Tyler Gigli Saw (Large Cut) 30cm

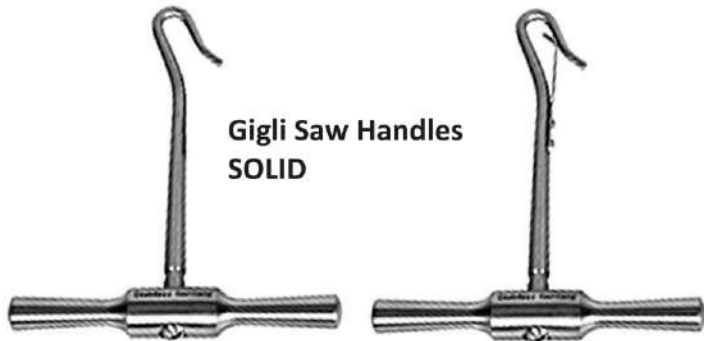

**Gigli Saw Handles**  
**SOLID**

**MD-11-01-001** Gigli Sold in Pair

**MD-11-01-002** Gigli Sold in Pair



**MD-11-01-005** BAILEY GIGLI SAW GUIDE 30 CM

**MD-11-01-006** POPPEN GIGLI SAW GUIDE 28 CM



**Gigli Saw Handles**  
**SOLID**

**MD-11-01-003** Gigli Sold in Pair

**MD-11-01-004** Gigli Sold in Pair



REAMERS - AWLS - BONE HOOKS



**MD-11-01-0329**

Reamer  
13.5cm / 5 1/4"



**MD-11-01-0330**

Perthes Reamer  
18 cm / 7"



**MD-11-01-0331**

Perthes Reamer  
21.5 cm / 8 1/2"



**MD-11-01-0332**

Reamer One concave  
side 14 cm / 5 1/2"

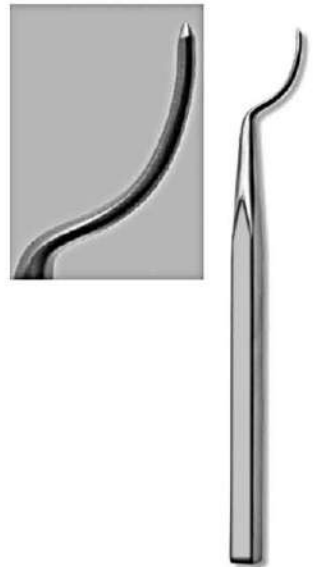

**MD-11-01-0333**

Glenoid Punch  
20 cm / 8"

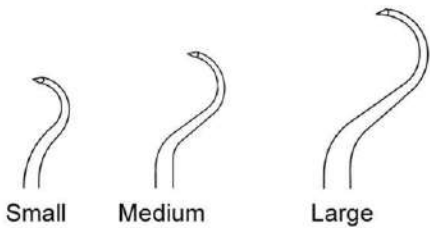

**MD-11-01-0334**

Shoulder Percussion Awl **A:** 21.5cm / 8 1/2" **B:** 23.5cm / 9 1/4"



**A:** 20cm / 8"  
19X27mm  
Sharp



**B:** 23cm / 9"  
15X20mm  
Blunt



**C:** 23cm / 9"  
15X20mm  
Sharp



**C:** 25cm / 9 3/4"  
15X20mm  
Sharp



**MD-11-01-0335** Volkman Bone Hook



REAMERS - AWLS - BONE HOOKS



Pointed

**MD-11-01-0336**

Kuntscher Diamond Awl 28 cm / 11"

Pointed

**MD-11-01-0337**

Rush Awl / Reamer

A: 19 cm / 7 1/2" 2.5mm

B: 21 cm / 8 1/4" 3mm

C: 21 cm / 8 1/2" 5mm

D: 26 cm / 10 1/2" 6mm

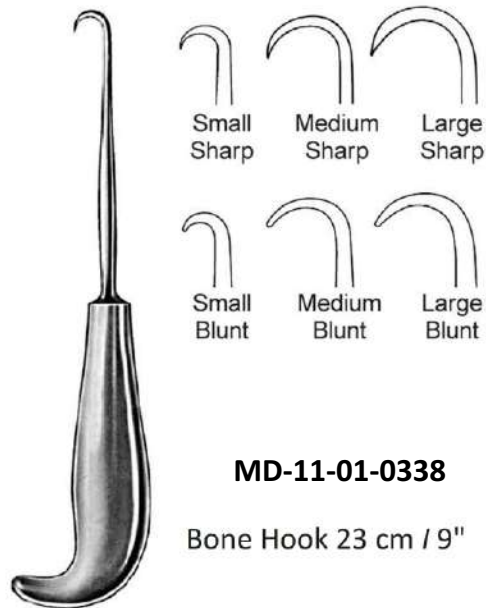

**MD-11-01-0338**  
Bone Hook 23 cm / 9"

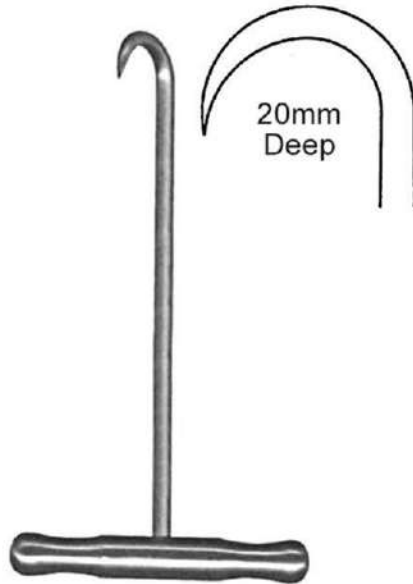

**MD-11-01-0339**

Bone Hook T Handle 20 cm / 8"



**MD-11-01-0340**

Bone Hook T Fiber Handle 14cm / 5 5/8"

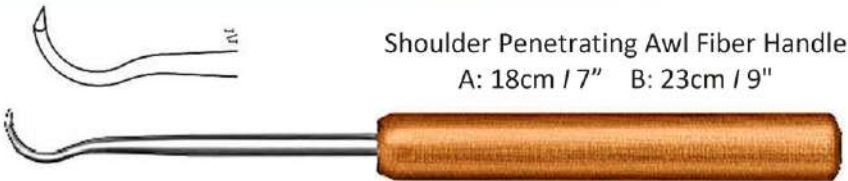

Shoulder Penetrating Awl Fiber Handle  
A: 18cm / 7" B: 23cm / 9"

**MD-11-01-0341**



**MD-11-01-0342**

Pointed Awl Fiber Handle 25cm / 10"

## ORTHOPEDIC HAND BONE DRILLS -ACC

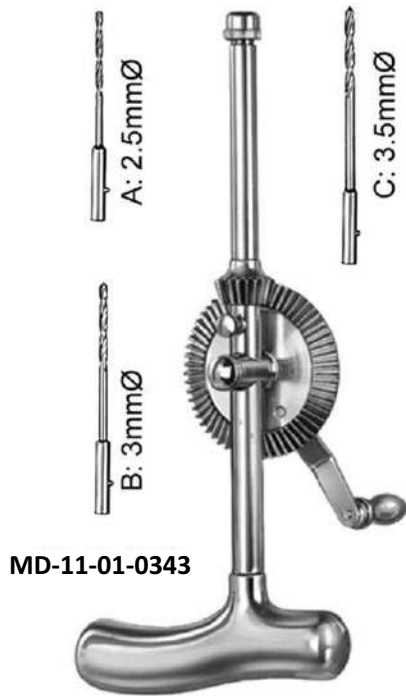

**MD-11-01-0343**

Stille-Sherman Hand Drill  
24 cm / 9 1/2" with 3 twist drills

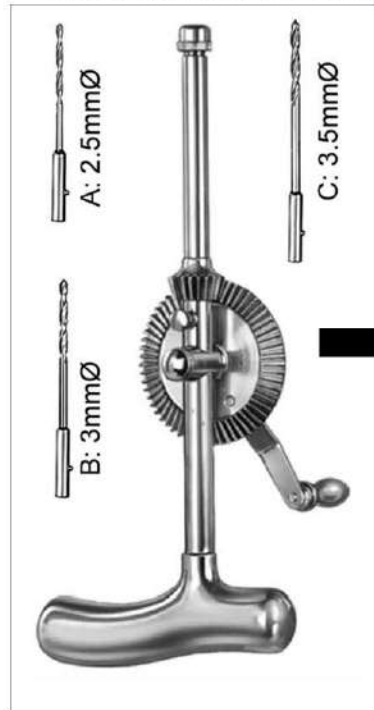

**MD-11-01-0344** Stille Hand Drill 20.5 cm / 8" w / 9 Twist Drills

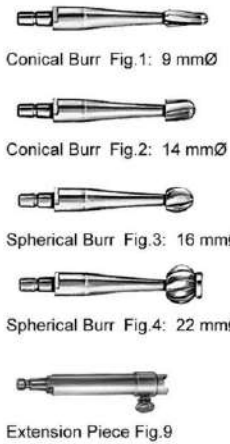
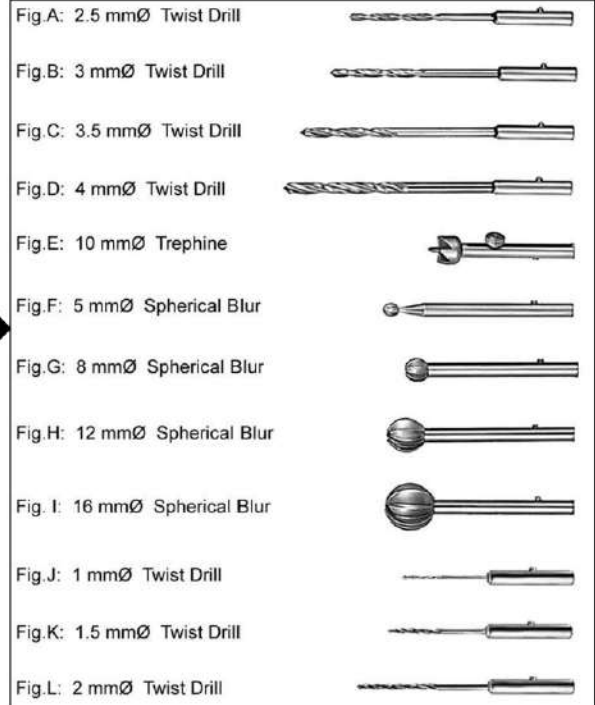

**MD-11-01-0345**

Hudson Hand Drill  
28 cm / 11"  
Complete with burrs Fig #. 1 - 4  
& additional price for additional  
accessories

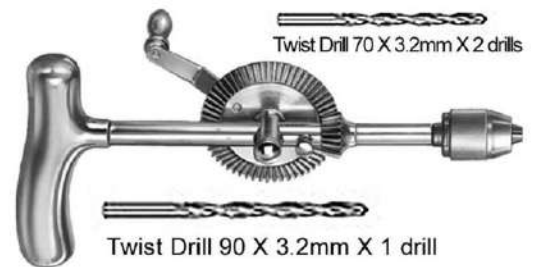
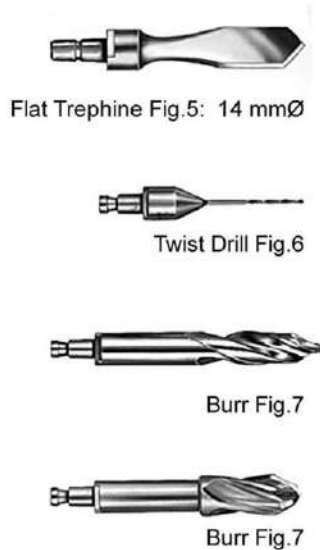

**MD-11-01-0346** Moore Hand Drill  
Complete with a set of 3 twist drills

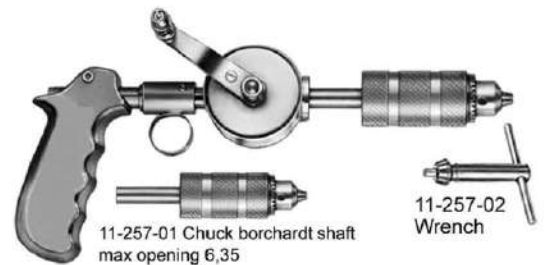

**MD-11-01-0347**

Martin Hand Drill with Chuck & Wrench

ORTHOPEDIC HAND BONE DRILLS -ACC



**MD-11-01-0348**

Bunnell Hand Drill  
16cm / 6-1/4"

Longitudinally Bored with 3-Jaw-Chuek  
Light Metal Housing opening up to 4mm



**MD-11-01-0349**

Bunnell Hand Drill  
16cm / 6-1/4"

Twin Shade Powder Coated Longitudinally  
bored with 3-Jaw-Chuek light metal  
housing opening up to 4mm



**MD-11-01-0350**

Ralk Hand Drill

Light Metal Housing  
Literally Angled Handle with 3-Jaw-Chuek  
and key, opening up to 6,35mm



**MD-11-01-0351**

**HAND DRILL**  
All Covered Polished / Dull or Coated.  
Drills Holder at Bottom.



**MD-11-01-0352**

**Hand Drill**  
All Covered Light Weight / Polished /  
Dull or Coated. Key Holder and Self  
Retaining Locking Mechanism



**Box for Hand Drills**  
Outside Artificial Leather  
/ inside Jumbo Foam



**MD-11-01-0353**

**Hand Drill**  
Polished / Dull or Coated. Operated  
Horizontally and Vertically



**MD-11-01-0354**

**Hand Drill**  
Polished / Dull or Coated.  
All Covered

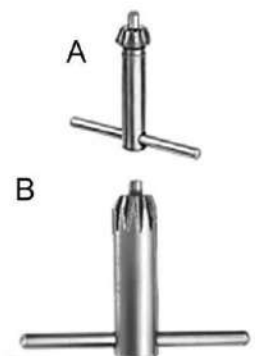

All Hand Drills  
Provided with Keys

ORTHOPEDIC HAND BONE DRILLS -ACC



**MD-11-01-0355**

Hand Drill  
Polished / Dull  
Or Coated.  
Open Housing



**MD-11-01-0356**

Hand Drill  
Polished / Dull  
Or Coated.  
Open Housing



**MD-11-01-0357**

Hand Drill  
Polished / Dull  
Or Coated.  
Semi Closed Housing



**MD-11-01-0358**

Vickers Easidriver 14 Cm / 5 1/2"



**MD-11-01-0355**

14 cm / 5 1/2"  
Handle W/ Chuck Longitudinally  
Bored Accommodating up to 3,95mm



**MD-11-01-0360**

Handle with chuck T-Shaped



**MD-11-01-0361**

Fiber T-Handle Key



**MD-11-01-0362**

Key



**MD-11-01-0363**

Key

## ORTHOPEDIC DRILL BITS – BURS - TREPHINES



### MD-11-01-01

5mm Borchardt Shaft Twist Drill, Long Working End

A: 2.0mm B: 2.5mm C: 3.0mm D: 3.2mm E: 3.5mm F: 4.0mm G: 5.0mm H: 6.0mm I: 7.0mm



### MD-11-01-02

5mm Borchardt Shaft Twist Drill

A: 1.0mm B: 1.5mm C: 1.8mm D: 2.0mm E: 2.2mm F: 2.5mm G: 2.8mm H: 3.0mm I: 3.2mm J: 3.5mm K: 4.0mm L: 5.0mm



### MD-11-01-03

5mm Borchardt Shaft Flat Trepine

A: 1.8mm B: 2.0mm C: 2.2mm D: 2.5mm E: 3.0mm F: 3.5mm G: 4.0mm H: 5.0mm



### MD-11-01-04

5mm Borchardt Shaft Spherical Burr

A: 3.0mm B: 4.0mm



### MD-11-01-05

5mm Borchardt Shaft Spherical Burr

A: 3.0mm B: 5.0mm



Long 5mm Borchardt Shaft

### MD-11-01-06

Doyen Spherical Burr

A: 4mm B: 6mm C: 8mm D: 10mm E: 12mm F: 14mm G: 16mm

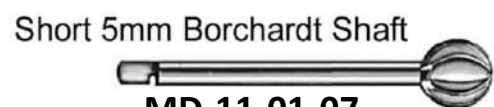

Short 5mm Borchardt Shaft

### MD-11-01-07

Doyen Spherical Burr

A: 4mm B: 6mm C: 8mm D: 10mm E: 12mm F: 14mm G: 16mm

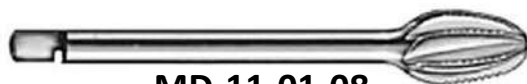

### MD-11-01-08

Doyen Conical Burr

Coarse Spacing 12mm Dia



### MD-11-01-09

Doyen Conical Burr

Fine Spacing A: 8mm / B: 10 mm



### MD-11-01-10

Doyen Cylindrical Burr

Coarse Spacing A: 12mm / B: 15mm



### MD-11-01-11

Albee Burr Oval Coarse Spacing

A: 8mm / B: 10 mm / C: 12 mm



### MD-11-01-12

Albee Burr Pointed 7 mm



### MD-11-01-13

Borchardt Burr Oval Coarse Spacing 13mm



### MD-11-01-14

Flat Burr Short Borchardt Shaft 25mm



### MD-11-01-15

Toti Trepine Short Borchardt Shaft 8mm

BONE HOLDING CLAMPS – TRACTION BAR



**MD-11-01-0364** Gerster-Lowman Bone Holding Clamp

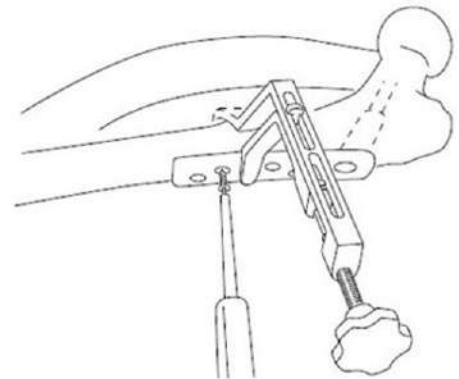
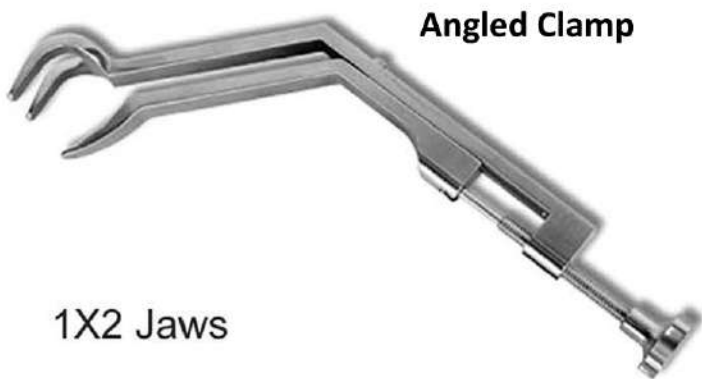
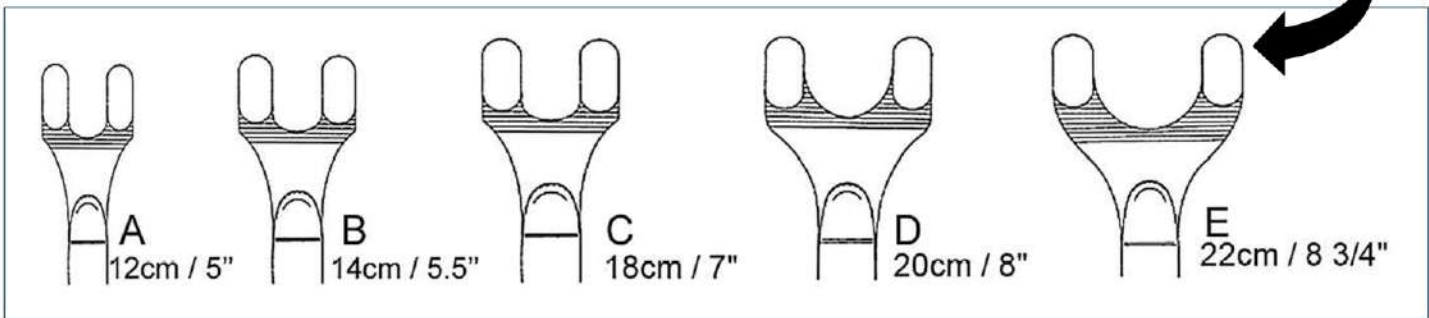

**MD-11-01-0365** Gerster-Lowman Bone Holding Clamp

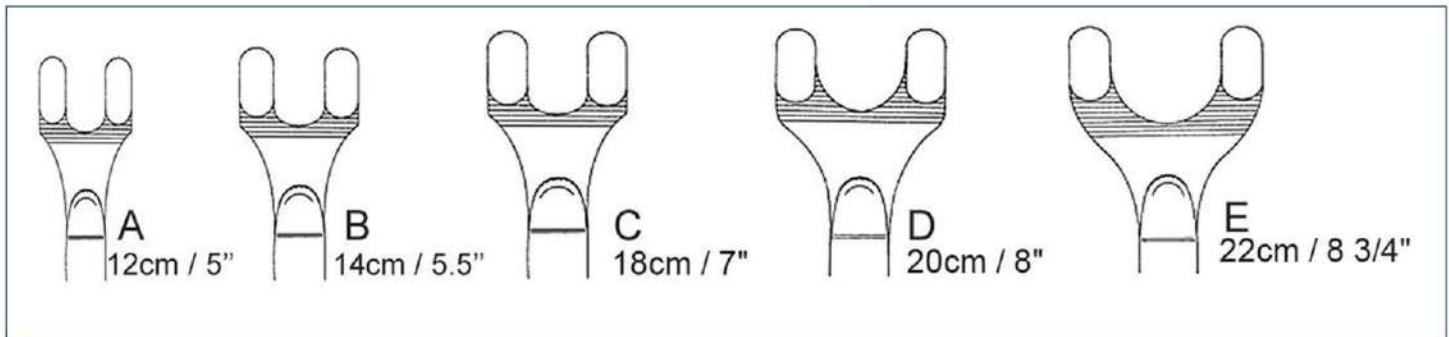

BONE HOLDING CLAMPS – TRACTION BAR



**MD-11-01-0366** Gerster Traction bar 15 cm / 6"

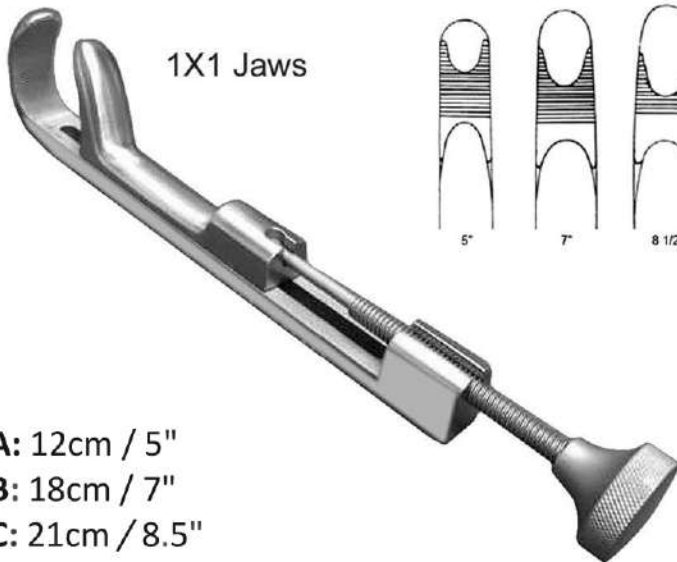

- A: 12cm / 5"
- B: 18cm / 7"
- C: 21cm / 8.5"

**MD-11-01-0367**  
Gerster-Lowman Bone Holding Clamp

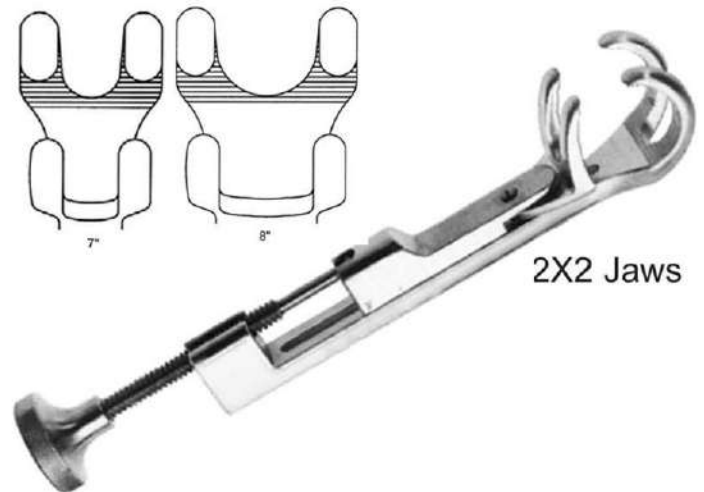

- A: 18cm / 7"
- B: 20cm / 8"

**MD-11-01-0368**  
Gerster-Lowman Bone Holding Clamp

WISE GRIPS – NOSE PLIERS – SLAP HAMMERS [ALL MADE OF STAINLESS STEEL]



**MD-11-01-0369**  
Vise Grip Locking Plier 23 cm / 9"



**HP-11-01-0370**  
Vise Grip Locking Plier 20.5 cm / 8"



**MD-11-01-0371**  
Vise Grip Locking Plier 18 cm / 7"



**MD-11-01-0372**  
Needle Nose Locking Plier 30 cm / 12"



**MD-11-01-0373**  
Needle Nose Locking Plier 25.5 cm / 10"

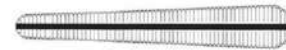

**MD-11-01-0374**  
Needle Nose Locking Plier 22 cm / 8.5"



**MD-11-01-0375**  
Flat Nose Plier 18.5 cm / 7 1/4" Parallel Grip SS



Max 1.6mm Cutting Capacity

**MD-11-01-0376**  
Flat Nose Plier-Cutter 18.5 cm / 7 1/4" Parallel Grip SS



**MD-11-01-0377**  
Long Nose Plier 22 cm / 8 1/4"



**MD-11-01-0378**  
Vise Grip 20.5 cm / 8" Stainless Steel



WISE GRIPS – NOSE PLIERS – SLAP HAMMERS [ALL MADE OF STAINLESS STEEL]



**MD-11-01-0379**

Regular Jaw Locking Plier

A: 18 cm / 7" B: 20 cm / 8" C: 23 cm / 9"



**MD-11-01-0380**

Needle Nose Locking Plier

A: 22 cm / 8.5" B: 25.5 cm / 10" C: 30 cm / 12"



**MD-11-01-0381**

SLAP HAMMER w/ Threaded Shaft Head



**MD-11-01-0382**

SLAP HAMMER w/ Hexa Shaft Head



**MD-11-01-0383**

Combi-Fiat Nose Pliers 15 cm / 6"

For Bending & Cutting



**MD-11-01-0385**

Flat Nose Plier 13.5 cm / 5 1/4"



**MD-11-01-0384**

Round / Flat Nose Pliers 18 cm / 7"



**MD-11-01-0386**

Hackstock Flat Nose Pliers 16 cm / 6 1/4"

NOSE PLIERS – PULLING FORCEPS – WIRE CUTTERS

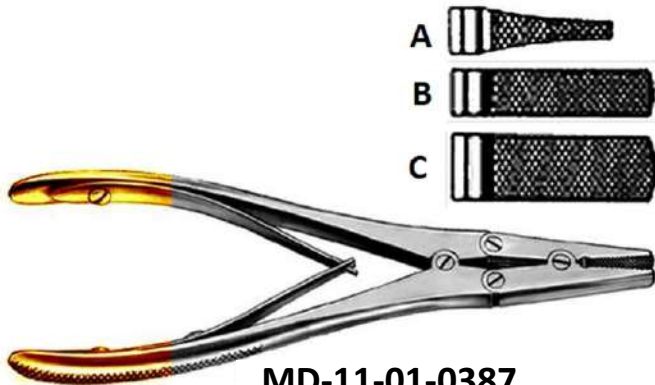

**MD-11-01-0387**  
Flat Nose Pliers 18 cm / 7" Parallel Grip



**MD-11-01-0388**  
Flat Nose Pliers 17 cm / 6 3/4" with crosswise groove



**MD-11-01-0389**  
Flat Nose Pliers 17.5 cm / 7"



**MD-11-01-0390**  
Flat Nose Pliers Pointed 19.5 cm / 7 3/4"



**MD-11-01-0391**  
Platypus Nail Pulling Forceps 15.5 cm / 6 1/4"

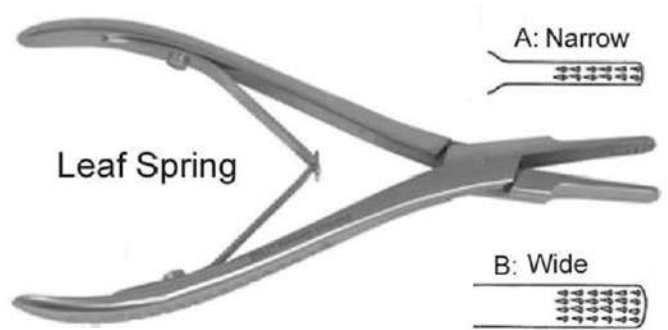

**MD-11-01-0392**  
Platypus Nail Pulling Forceps 15.5 cm / 6 1/4"



**MD-11-01-0393**  
Round Nose Pliers 15.5 cm / 6 1/4"

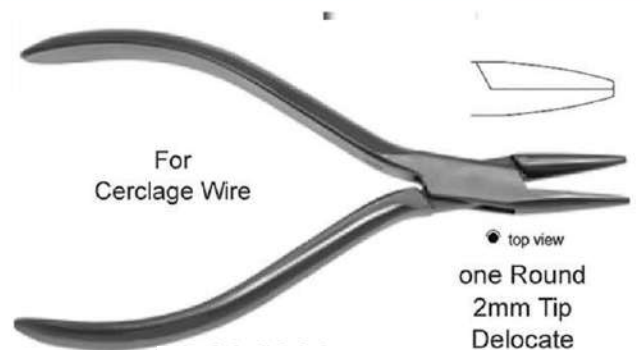

**MD-11-01-0394**  
Needle Nose Pliers 15.5 cm / 6 1/4"

NOSE PLIERS – PULLING FORCECEPS – WIRE CUTTERS

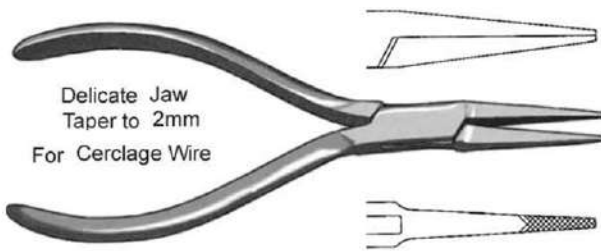

**MD-11-01-0395**  
Flat Nose Pliers 15 cm / 6"

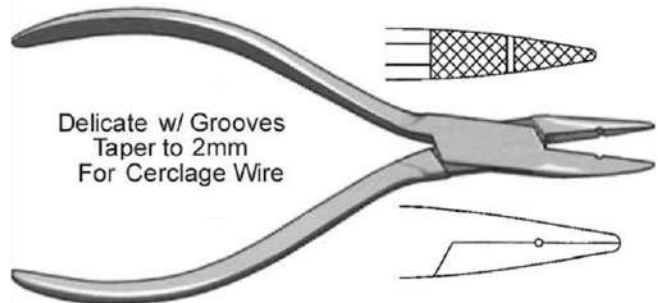

**MD-11-01-0396**  
Needle Nose Pliers 13.5 cm / 5 1/4"

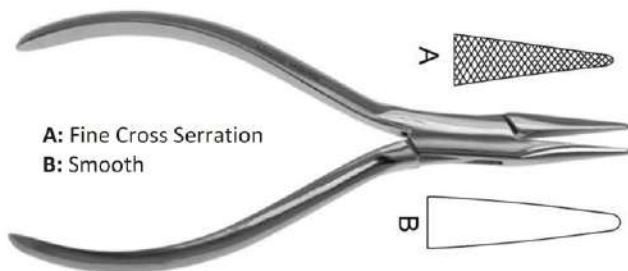

**MD-11-01-0397**  
Needle Nose Pliers Taper to 2mm Tip 14 cm / 5 1/2"



**MD-11-01-0398**  
Wire Cutting Pliers 18.5 cm / 7 1/4"



**MD-11-01-0399**  
Martin "Diamant" 16cm / 6 1/4"



**MD-11-01-0400**  
Circlage Pliers / Cutter 14 cm / 5 1/2"

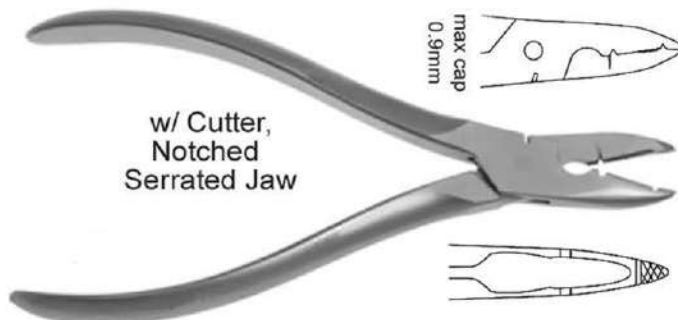

**MD-11-01-0401**  
Wire Bending Pliers 20 cm / 8"

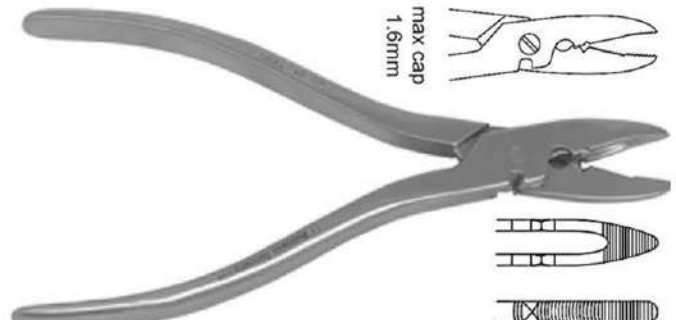

**MD-11-01-0402**  
Wire Bending Pliers 15 cm / 6"

NOSE PLIERS – PULLING FORCEPS – WIRE CUTTERS



**MD-11-01-0403**

Wire Bending Pliers TC 20 cm / 8"

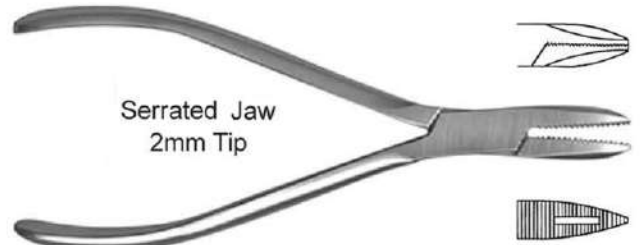

Serrated Jaw  
2mm Tip

**MD-11-01-0404**

Needle Nose Pliers 15 cm / 6"

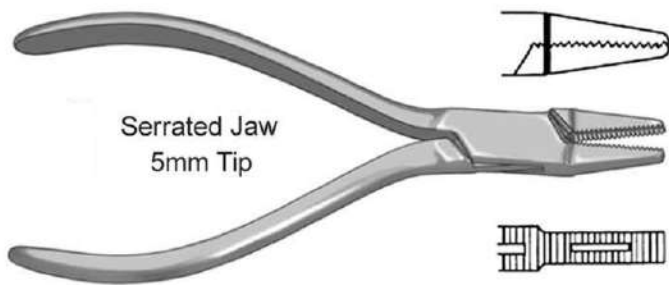

Serrated Jaw  
5mm Tip

**MD-11-01-0405**

Flat Nose Pliers 14 cm / 5 1/2"

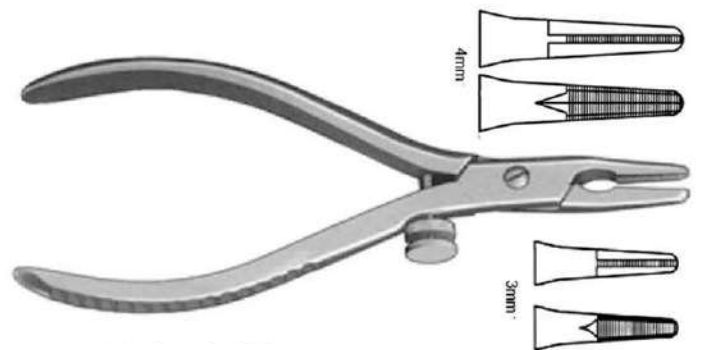

**MD-11-01-0406**

K-Wire Pliers A: 13 cm / 5" B: 17.5 cm / 7"

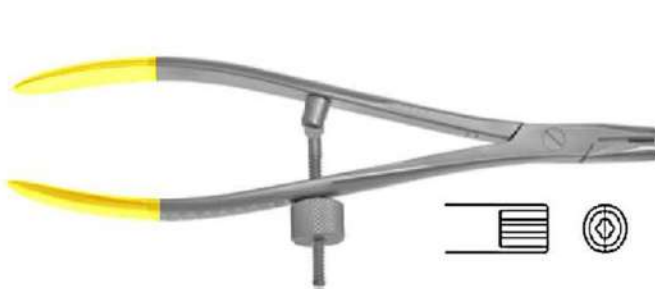

**MD-11-01-0407**

Screw/Pin Removing Pliers 19 cm / 7 1/2"

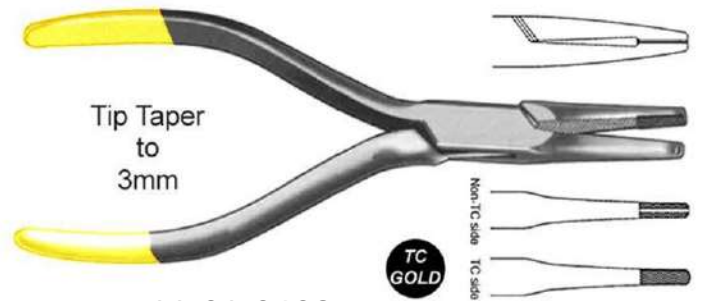

Tip Taper  
to  
3mm

TC  
GOLD

**MD-11-01-0408**

Pin Puller Grips Small Pins 14 cm / 5 1/2"

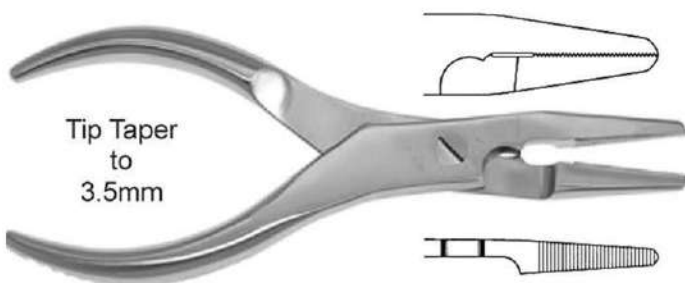

Tip Taper  
to  
3.5mm

**MD-11-01-0409**

Flat Nose Pliers w/ Cutter for Cerclage Wire 16 cm / 6 1/2"



Tip Taper  
to  
3.5mm

**MD-11-01-0410**

19 cm / 7 1/2" Narrow Nose Pliers Heavy Jaws  
for Pulling Wire / Pins

PLIERS – BENDERS – ROD INSTRUMENTS

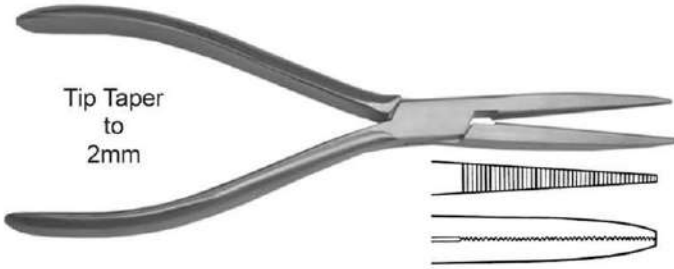

Tip Taper to 2mm

**MD-11-01-0411**

Long Jaw Pliers 2inch Long Jaw Delicate 17.5 cm / 7"

- A: 17.5 cm / 7" Needle Nose 2" Jaw
- B: 16 cm / 6 1/2" Square 7mm Jaw
- C: 18 cm / 7" Tape to 2mm Tip

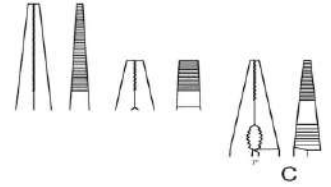

**MD-11-01-0412**

**UNIVERSAL Pliers**  
Serrated w/ Heavy duty Spring and Cutting Edge  
Max Cutting Cap: 1.1 mm

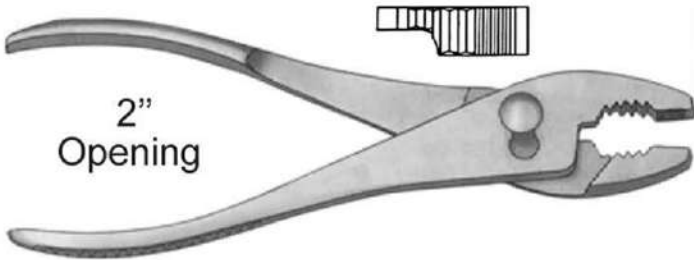

2" Opening

**MD-11-01-0413**

Slip Joint Pliers 20 cm / 8"

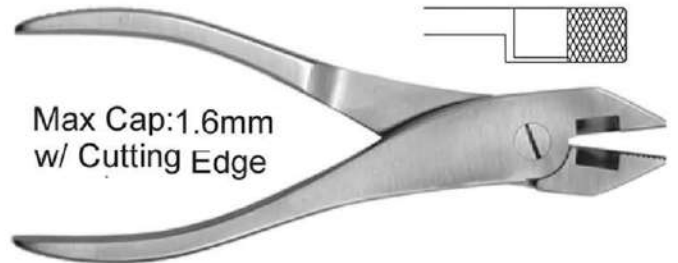

Max Cap: 1.6mm w/ Cutting Edge

**MD-11-01-0414**

Lineman Pliers 21 cm / 8 1/2"

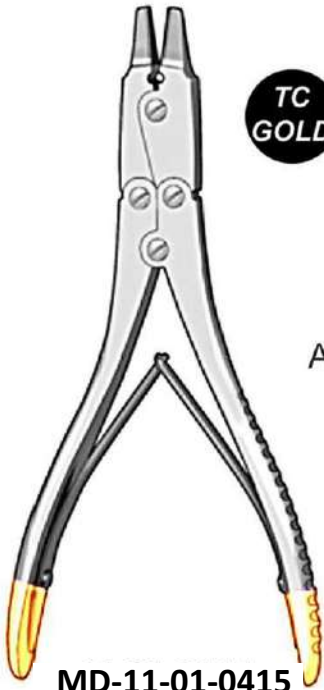

**TC GOLD**

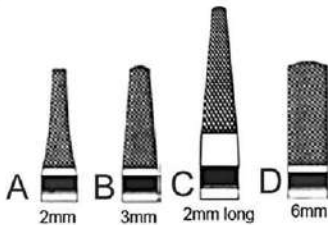

- A: 2mm Delicate Jaw TC
- B: 3mm Jaw TC
- C: 2mm Long Jaw TC
- D: 6mm Jaw TC

**MD-11-01-0415**

Double Action Wire Extraction Plier  
18 cm / 7"

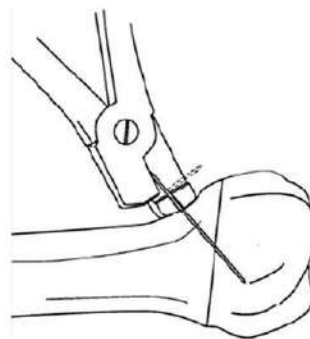

**MD-11-01-0416**

Gratloch Wire Bender  
19 cm / 7 1/2"

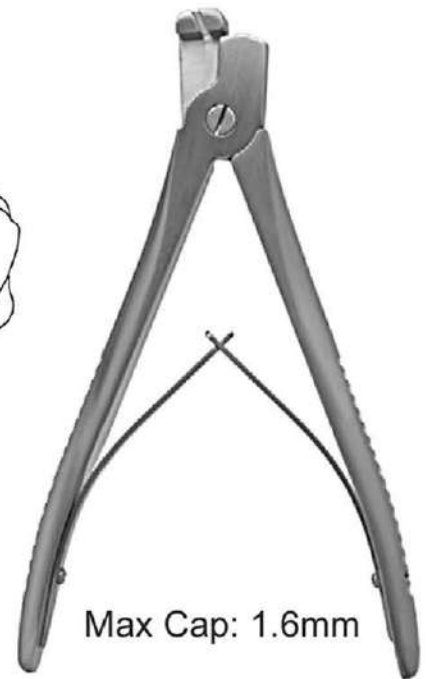

Max Cap: 1.6mm

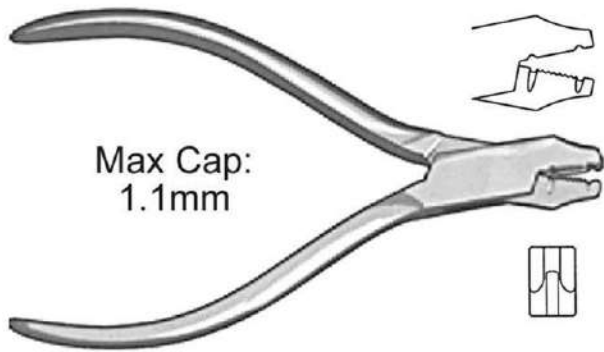

Max Cap:  
1.1mm

**MD-11-01-0417**

K-Wire / Plate Bender 13.5cm / 5"

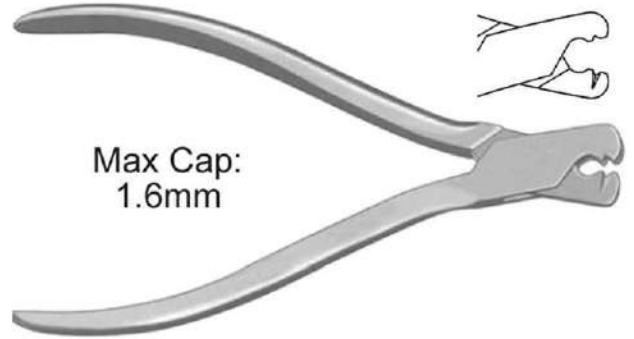

Max Cap:  
1.6mm

**MD-11-01-0418**

K-Wire / Plate Bender 14.5 cm / 5 1/2"

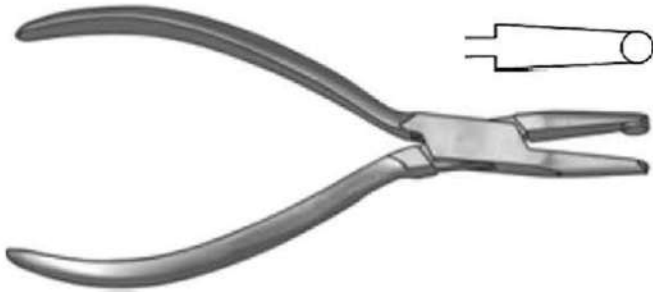

**MD-11-01-0419**

Mini Plate Bending Pliers 13.5 cm / 5"

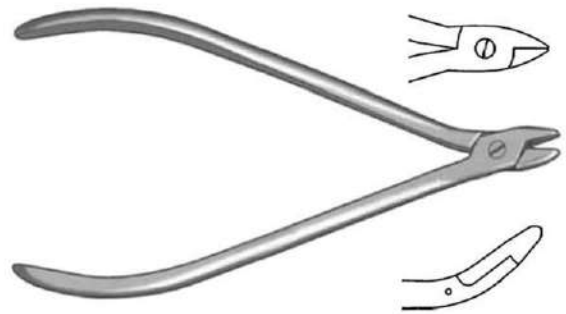

**MD-11-01-0420**

Plate Bending Pliers 14.5 cm / 5 1/2"

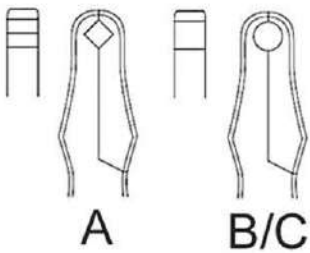

- A: 5.5mm Rods Prism
- B: 5.5mm Rods
- C: 6.35mm Rods

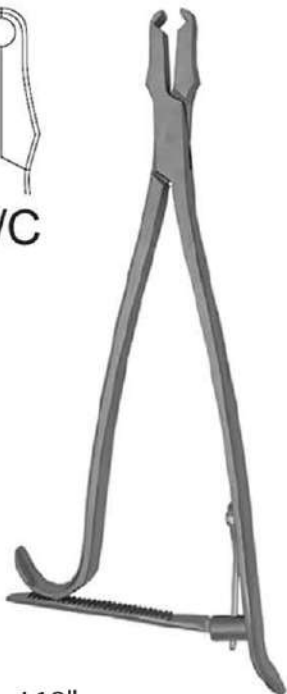

**MD-11-01-0421**

Rod Holder STR 25 cm / 10"

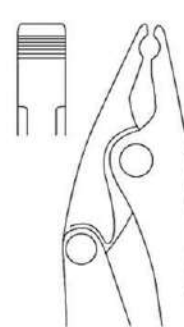

**MD-11-01-0422**

Rod Gripper Adjustable  
21 cm / 8 1/2"

WIRE INSTRUMENTS – EXTENSION BOWS

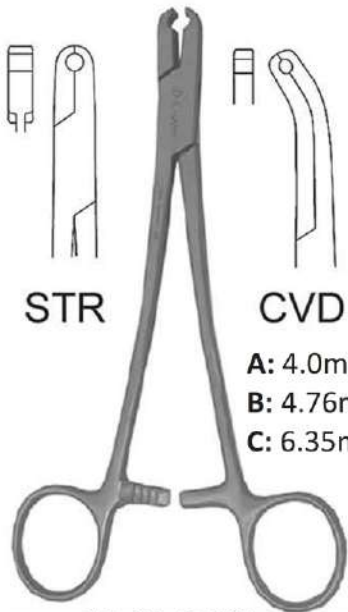

STR

CVD

- A: 4.0mm Rod
- B: 4.76mm Rod
- C: 6.35mm Rod

**MD-11-01-0423**

Rod Holder 18 cm / 7 ¼"



**MD-11-01-0424**

Wire Pulling Forceps 16 cm / 6 ½"

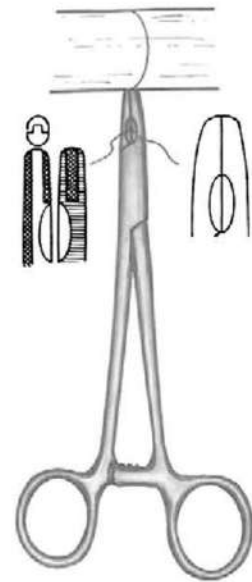

**MD-11-01-0425**

Wire Twister / Tightner 16cm / 6 ¼"



**MD-11-01-0426**

Loute Wire Tightener 21 cm / 8 ¼"



**MD-11-01-0428**

Wire Tightener w / T Handle  
11.5 cm / 4 ½"



**MD-11-01-0427**

Wire Tightener 12 cm / 4 ¾"

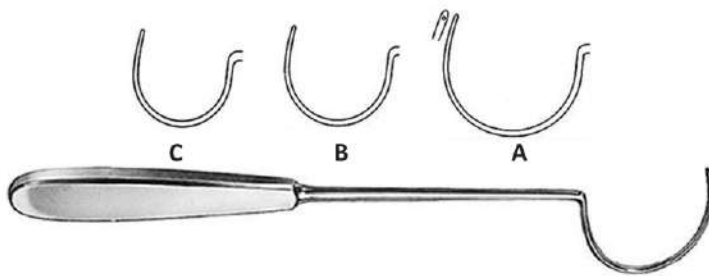

A: 31 cm / 12 1/4"  
B: 29 cm / 11 1/2"  
C: 28 cm / 11"

**MD-11-01-0429**  
Demel Wire Guide



CVD Crochet Hook  
18cm / 7 1/4"

**MD-11-01-0430**  
Bankert Ligature Carrier

CVD  
Crochet Hook Fiber handle  
A: 18cm / 7" B: 23cm / 9"



**MD-11-01-0431**  
Suture Passer

CVD  
Suture Hole Fiber Handle  
A: 18cm / 7" B: 23cm / 9"



**MD-11-01-0432**  
Suture Passer



Suture Hole  
20cm / 8"  
A: Right Blunt  
B: Left Blunt  
C: Right Sharp  
D: Left Sharp

**MD-11-01-0433**  
Deschamps Ligature Carrier

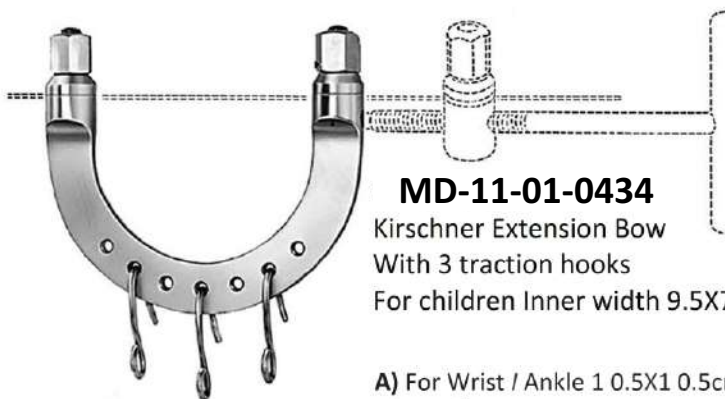

**MD-11-01-0434**  
Kirschner Extension Bow  
With 3 traction hooks  
For children Inner width 9.5X7cm

- A) For Wrist / Ankle 1.05X1.05cm
- B) For Elbow 12X12cm
- C) For Knee 15.5X15.5cm
- D) For Femur 20X15.5cm

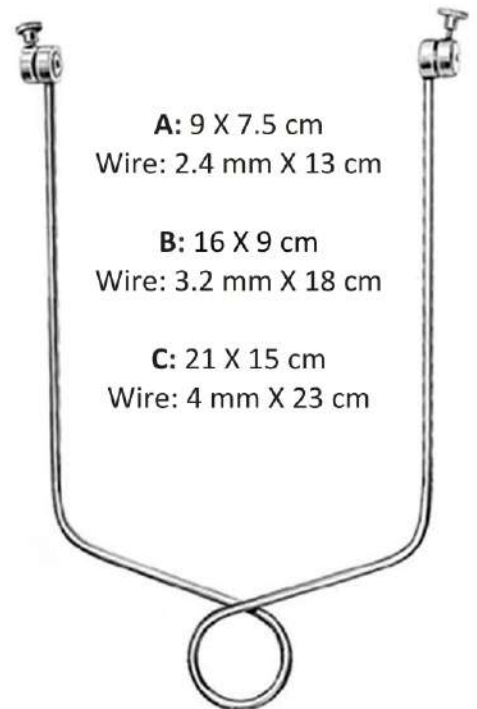

**MD-11-01-0435**  
Bohler Extension Bow for femur & knee



WIRE INSTRUMENTS – EXTENSION BOWS

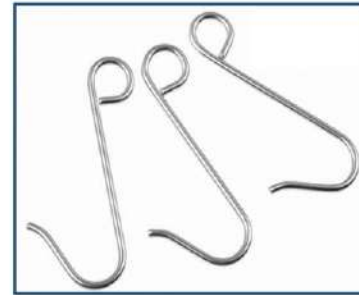
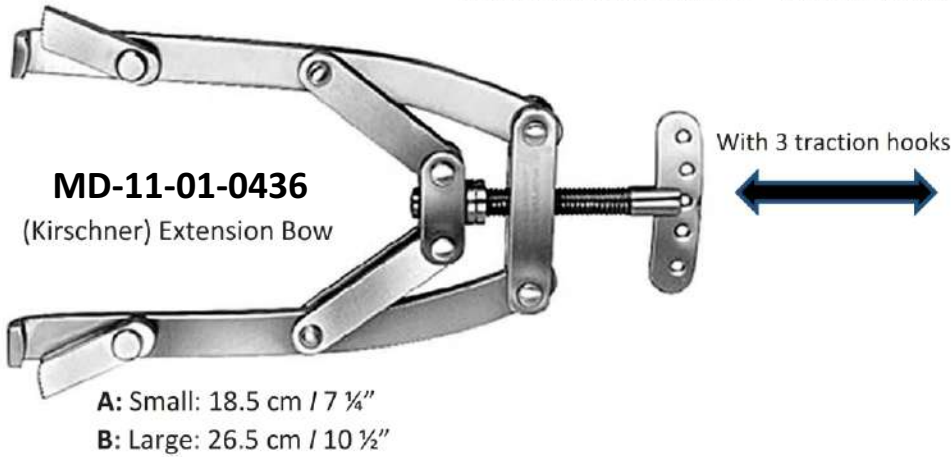

**Traction Hook**  
For Extension Bows



**MD-11-01-0437**  
Extension Bow  
A: 10 ½" X 6 ¼"  
B: 7" X 4"



**MD-11-01-0438**  
Wire Strainer 18.5 cm / 7 ¼"



**MD-11-01-0439**  
Wrench 20 cm / 8"



**MD-11-01-0440**  
Fixation Discs  
For wire drills, pair

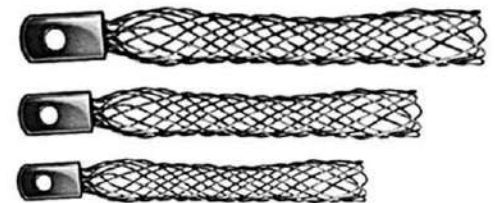

**MD-11-01-0441**  
Extension Sleeve  
Small / Medium / Large

RING CUTTERS – LEAD HANDS – BIOPSY TOOLS



**Complete with Drills**  
(Set of 3 drills) Small / Medium / Large

**MD-11-01-0442**  
Martin-Ideal  
Finger Nail Drill



**MD-11-01-0443**  
Feldheim Tourniquet 10 cm / 4"



**MD-11-01-0444**  
Radolf Nail Extracting Forceps  
14 cm / 5 1/2"

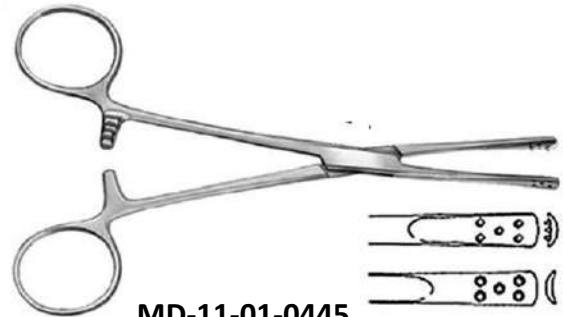

**MD-11-01-0445**  
Nail Extracting Forceps 16 cm / 6 1/4"



**MD-11-01-0446**  
Martin Finger Ring Saw 18.5 cm / 6 3/4"  
Spare Blades are Available Separately



**MD-11-01-0447**  
Walton Finger Ring Saw 16cm / 6 1/4"  
Spare Blades are Available Separately



**MD-11-01-0448**  
Finger Ring Saw 17cm / 6 3/4"  
Spare Blades are Available Separately



Stainless Steel  
Black Color



Stainless Steel  
Color

**MD-11-01-0449**  
Finger Ring Saw Cutter Spare

RING CUTTERS – LEAD HANDS – BIOPSY TOOLS



**MD-11-01-0450**

Lead Hand for Kids / Adults

**MD-11-01-0451**

Lead Hand for Kids / Adults

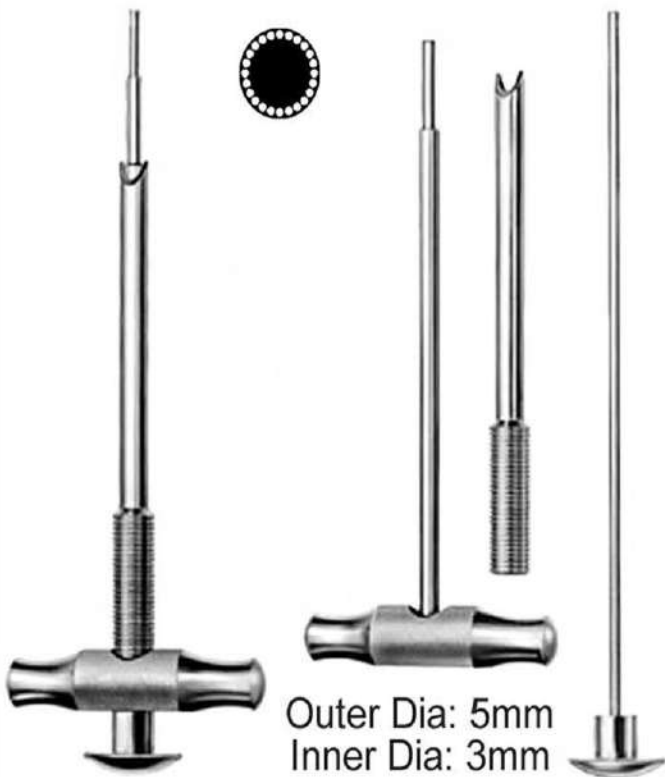

Outer Dia: 5mm  
Inner Dia: 3mm

**MD-11-01-0452**

Champy-OSU Bone Biopsy Instruments

22 cm / 8 3/4"

Consisting of trocar, a toothed trephine and a plunger for taking tibial and iliac bone grafts through a closed technique

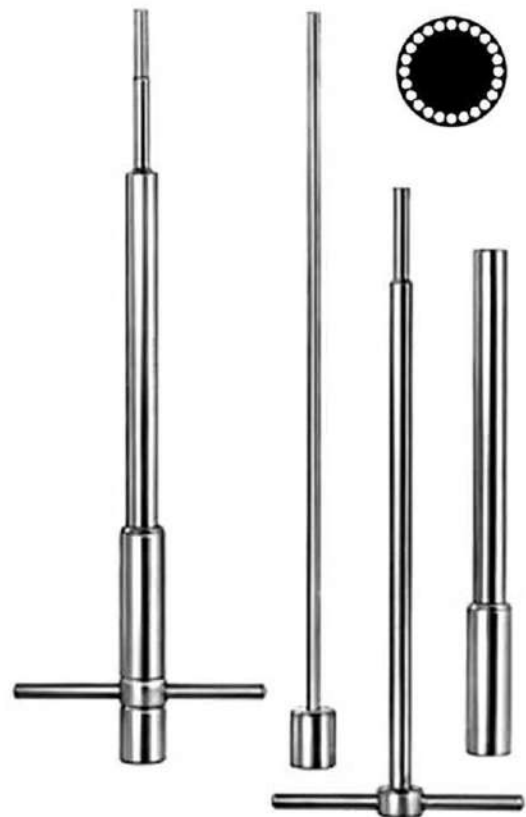

**MD-11-01-0453**

Champy Bone Biopsy Instruments

22 cm / 8 3/4"

- A) Outer Dia: 5mm / Inner Dia: 4mm
- B) Outer Dia: 8mm / Inner Dia: 7mm

BONE TAMPERS – IMPACTORS - PACKERS



**MD-11-01-0454**

Bone Tamper  
15.5 cm / 6" Tip  
Sizes: 2-3-4-5-6-8-9-10 mm



**MD-11-01-0455**

Champy Cancellous Bone graft Mill

Outer Dia: 17mm  
Inner Dia: 16mm



**MD-11-01-0456**

Bone Impactor / Teflon Tip 17cm / 6 1/2"



**MD-11-01-0457**

Caspar Bone Tamper 20 cm / 8"



**MD-11-01-0458**

Lumbar / Cervical Impactor 21cm / 8 1/2"

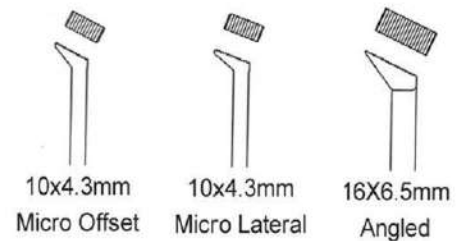

**MD-11-01-0459**

Lumbar / Cervical Impactor 21cm / 8 1/2"

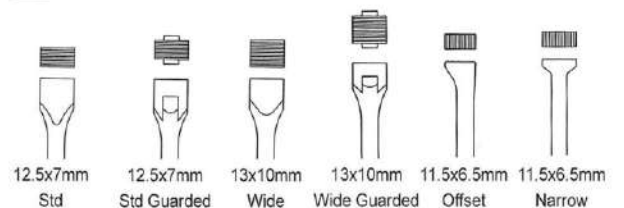



## BONE RASPS - FILES



**MD-11-01-0460**

Bone Chip Packer 25cm / 10"

A: 2x9mm B: 3x16mm  
C: 6x9mm D: 6x19mm  
E: 6mm Dia

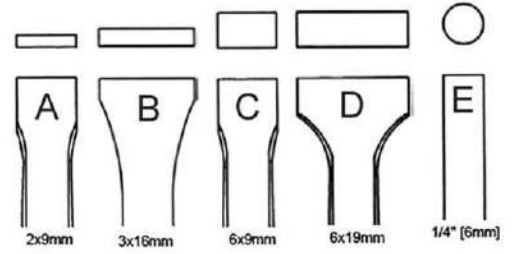

**MD-11-01-0461**

Bone Tamper 43 cm / 17"



9.5mm DIA



**MD-11-01-0462**

Putti Bone Rasp Round / Semi Round  
30 cm / 11 3/4"



**MD-11-01-0463**

Putti Bone Rasp Curved / Straight  
27cm / 10 3/4"



**MD-11-01-0464**

Bone File 28 cm / 11" w/ Hollow Handle Semi Round



**MD-11-01-0465**

Bone File 24.5 cm / 9 3/4" w/ Hollow Handle Semi



**MD-11-01-0466**

Bone File 22 cm / 8 3/4" Flat / Round



**MD-11-01-0467**

Bone Rasp 22 cm / 8 3/4" Flat / Round



**MD-11-01-0468**

Bone File Fiber Handle 18cm / 7"



A: Straight  
B: Curved Forward  
C: Curved Backward



**MD-11-01-0469**

Bone File 18 cm / 7" Fiber Handle / Cross-Hatch



**MD-11-01-0470**

Bone File 18 cm / 7" Fiber Handle / Linear

## BONE RASPS - FILES



**MD-11-01-0471A**

Bone File 18 cm / 7" Fiber Handle / STR Diamond Coated



**MD-11-01-0471B**

Bone File 18 cm / 7" Fiber Handle / CVD Diamond Coated



**MD-11-01-0472A**

Bipolar Bone Rasp w / Rod



**MD-11-01-0472B**

Femoral Bone Rasp w / Rod

A: Small B: Medium C: Large

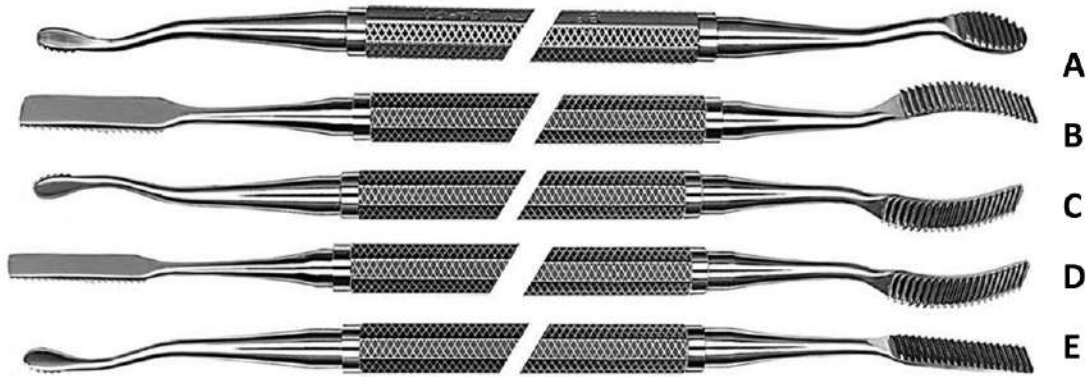

**MD-11-01-0473**

Miller-Colburn Bone File 18 cm / 7" Downwards Cut

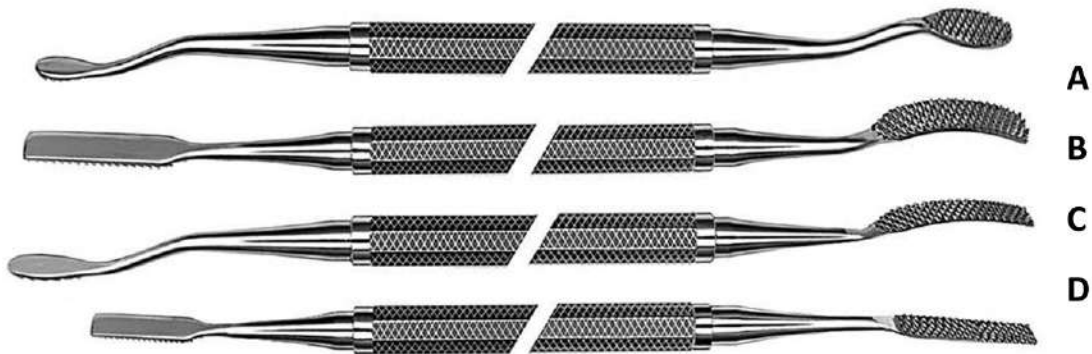

**MD-11-01-0474**

Miller-Colburn Bone File 18 cm / 7" Cross Cut

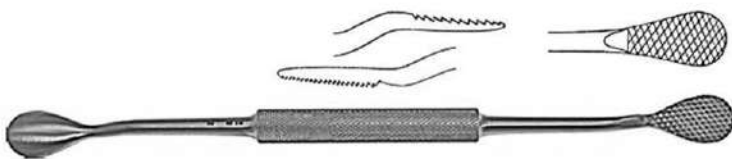

**MD-11-01-0475**

Bone Rasp 21 cm / 8.5" 13mm Fine/Coarse  
Straight

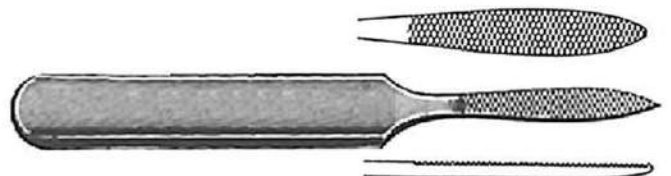

**MD-11-01-0476**

Bone Rasp Joseph 16 cm / 6.25" 8mm  
Fine Cross Serrated / Straight

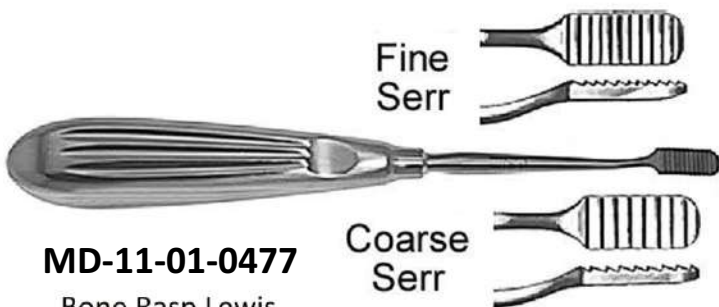

**MD-11-01-0477**

Bone Rasp Lewis  
19 cm / 7.5" 8mm

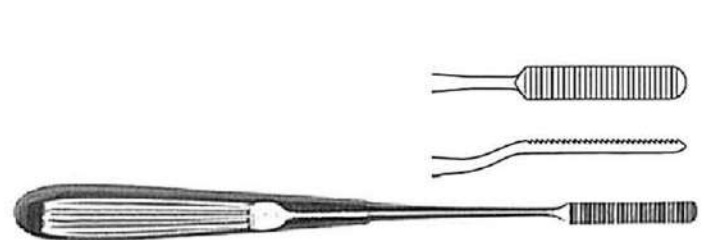

**MD-11-01-0478**

Bone Rasp Cottle  
20 cm / 8" 7mm Plain Serrated Downward

BONE RASPS - FILES

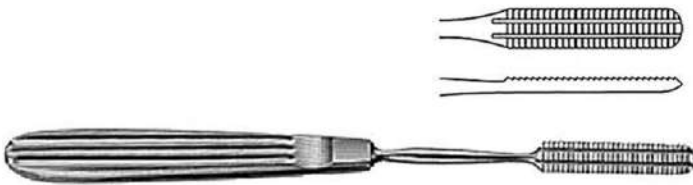

**MD-11-01-0479**

Bone Rasp Maltz 18 cm / 7"  
9mm Plain Coarse Serr Downward



**MD-11-01-0480**

Bone Rasp Aufriecht 18 cm / 7"  
9mm Coarse Serr CVD

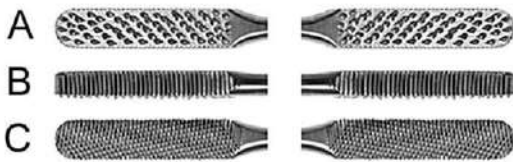

**MD-11-01-0481**

Bone Rasp Fomon 21 cm / 8.5"  
8mmX40mm Course Serr 4 Sided Flat / Convex Baldes



**MD-11-01-0482**

Bone Rasp Fomon 21 cm / 8.5"  
8mmX40mm Fine Serr 4 Sided Flat / Convex Blades



**MD-11-01-0483**

Bone Rasp Kleinert Kurtz 21 cm / 8.5"  
8mmX45mm Fine/Coarse Serr 4 Sided Flat / Convex

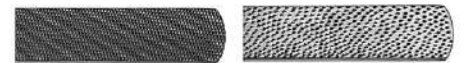

**MD-11-01-0484**

Bone File / Rasp 21 cm / 8.5"  
18mm Fine / Coarse Serr



BONE LEVERS - RETRACTORS



**MD-11-01-0485**  
Bone Lever 16 cm / 6 ¼"



**MD-11-01-0486**  
Hohman, Mini Bone Lever 16 cm / 6 ¼" 6 mm tip



**MD-11-01-0487**  
Hohman, Mini Bone Lever 16 cm / 6 ¼" 8 mm tip



**MD-11-01-0488**  
Mini Bone Lever 16cm / 6 ¼" 14 mm tip

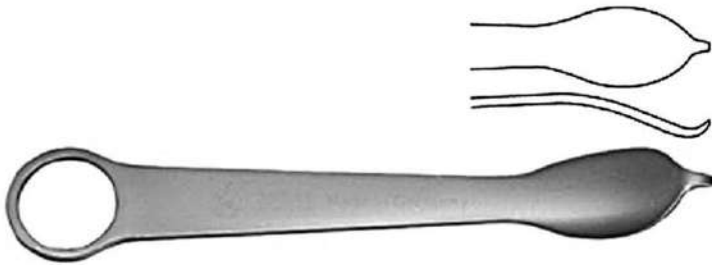

**MD-11-01-0489**  
Hohman, Mini Bone Lever 12 cm / 4 ¾" 14 mm tip

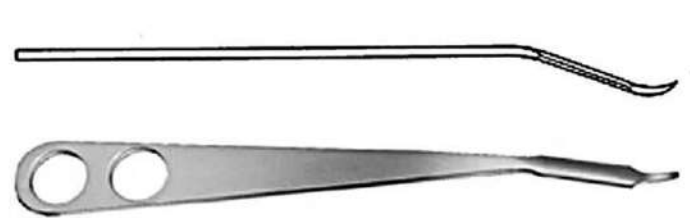

**MD-11-01-0490**  
Hohmann Bone Lever 22 cm / 8 ¾" 8 mm Tip narrow tip

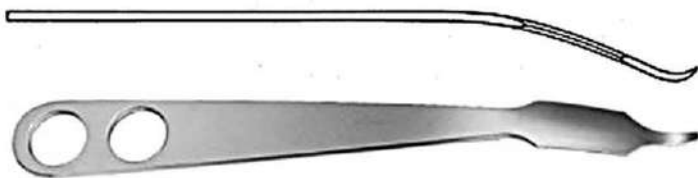

**MD-11-01-0491**  
Hohmann Bone Lever 23.5 cm / 9 ¼" 18 mm Tip narrow tip



**MD-11-01-0492**  
Hohmann Bone Lever 23.5 cm / 9 ¼" 43 mm Tip narrow tip



**MD-11-01-0493**  
Hohmann Bone Lever 29 cm / 11 ½" 35mm Tip wide tip



**MD-11-01-0494**  
Lange-Hohmann Bone Lever 25 cm / 9 ¾" 22mm Tip  
Wide tip with groove

## BONE LEVERS - RETRACTORS

**A:** 43 mm  
**B:** 60 mm

**MD-11-01-0495**  
Bennett Bone Lever 24 cm / 9 1/2"

**MD-11-01-0496**  
Hohmann Bone Lever 27.5 cm / 10 3/4"  
24mm Tip wide, round tip

**MD-11-01-0497**  
Hohmann Bone Lever 25 cm / 9 3/4" 70 mm Tip narrow tip

**MD-11-01-0498**  
Blount Knee Retractor 26.5 cm / 10 1/2" blunt

**MD-11-01-0499**  
Hohmann Bone Lever 23.5 cm / 9 1/4" 43mm Tip narrow tip

**MD-11-01-0500**  
Blount Knee Retractor 26.5 cm / 10 1/2"

**MD-11-01-0501**  
Hohmann Bone Lever 25.5 cm / 10" 22mm Tip wide tip

**MD-11-01-0502**  
Blount Knee Retractor 17.5 cm / 7"

**Sizes Available:**

- A:** 75 X 30 mm
- B:** 100 X 30 mm

**11-01-0503**  
Taylor Spinal  
Retractor  
16 cm / 6 1/4"  
Pointed end

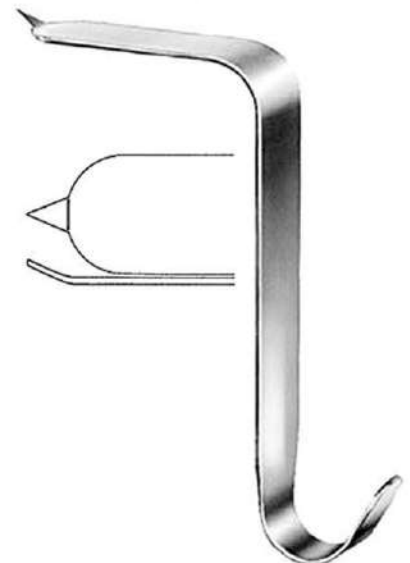

## BONE LEVERS - RETRACTORS

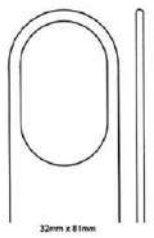

**MD-11-01-0504**  
Fukuda Retractor  
19 cm / 7 1/2"  
T-Handle

A: 32X81mm  
B: 38X81mm

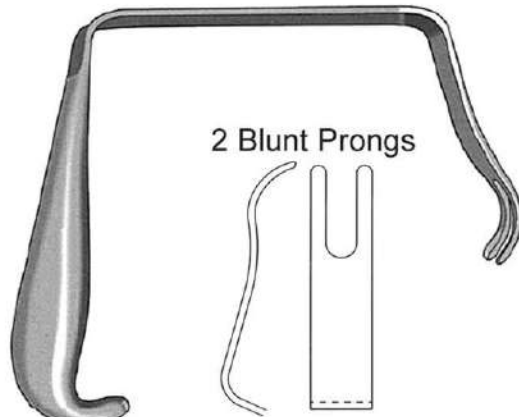

**MD-11-01-0505**  
Bristow / Bankart Humeral Retractor  
18 cm / 7"



**Medium Blade:**  
57 / 69mm Deep  
11mm Wide

**Large Blade:**  
63 / 76mm Deep  
11mm Wide

**MD-11-01-0506**  
Z Knee Retractor 15 cm / 6"



**MD-11-01-0507**  
Deltoid Retractor 28 cm / 11" T Handle w / Ring

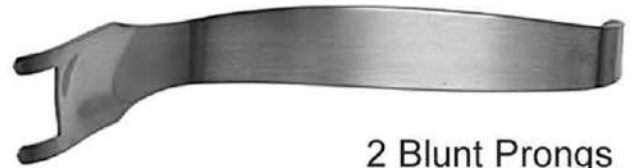

**MD-11-01-0508**  
Humeral Head Retractor 18 cm / 7" Strong Curved

22 mm Blade  
1 Sharp Prong

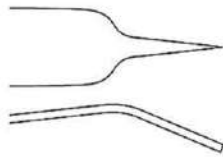

**MD-11-01-0509**  
Capsule Retractor 25 cm / 10"

22 mm Blade  
2 Sharp Prong

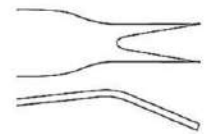

**MD-11-01-0510**  
Capsule Retractor 25 cm / 10"

3 Sharp Prongs

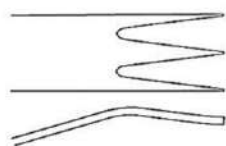

**MD-11-01-0511**  
Capsule Retractor 25 cm / 10"

Soft Tissue Retractor  
3 Blunt Prong

22mm  
Blade

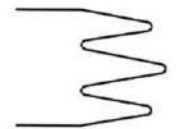

**MD-11-01-0512**  
Bristow / Bankart 19 cm / 7 1/2"

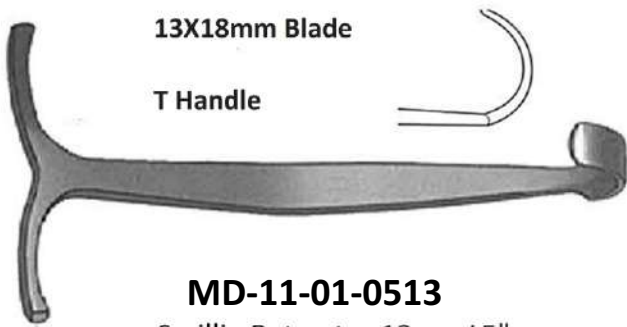

13X18mm Blade

T Handle

**MD-11-01-0513**  
Smillie Retractor 13 cm / 5"



13X55 mm Blade

T Handle

**MD-11-01-0514**  
Smillie Retractor 14 cm / 5 1/2"

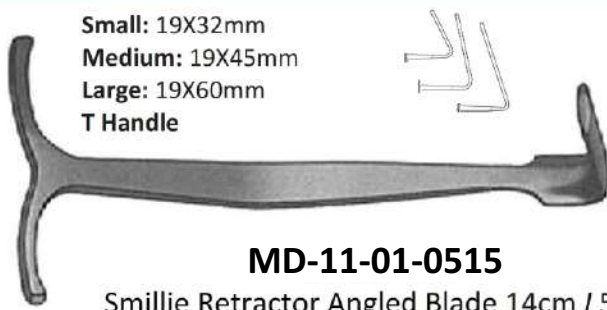

Small: 19X32mm  
Medium: 19X45mm  
Large: 19X60mm  
T Handle

**MD-11-01-0515**  
Smillie Retractor Angled Blade 14cm / 5 1/2"



9 X 38 mm Blade

**MD-11-01-0516**  
Knee Retractor 22 cm / 8 1/2" Ring Handle

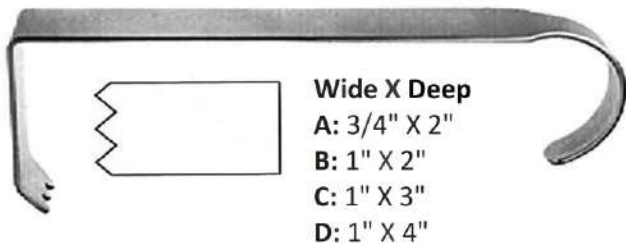

Wide X Deep

- A: 3/4" X 2"
- B: 1" X 2"
- C: 1" X 3"
- D: 1" X 4"

**MD-11-01-0517**  
Hibbs Retractor 24 cm / 9 1/2" Sharp Teeth

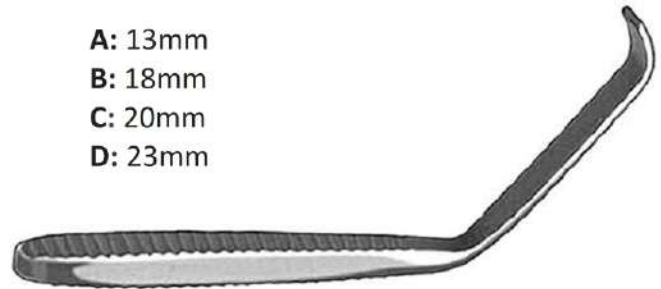

- A: 13mm
- B: 18mm
- C: 20mm
- D: 23mm

**MD-11-01-0518**  
Blade Retractor 19 cm / 7 1/2"

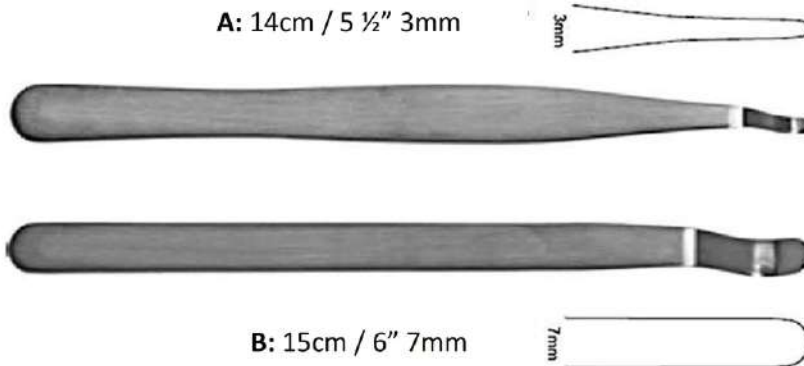

A: 14cm / 5 1/2" 3mm

3mm

B: 15cm / 6" 7mm

7mm

**MD-11-01-0519** Hayes Retractor

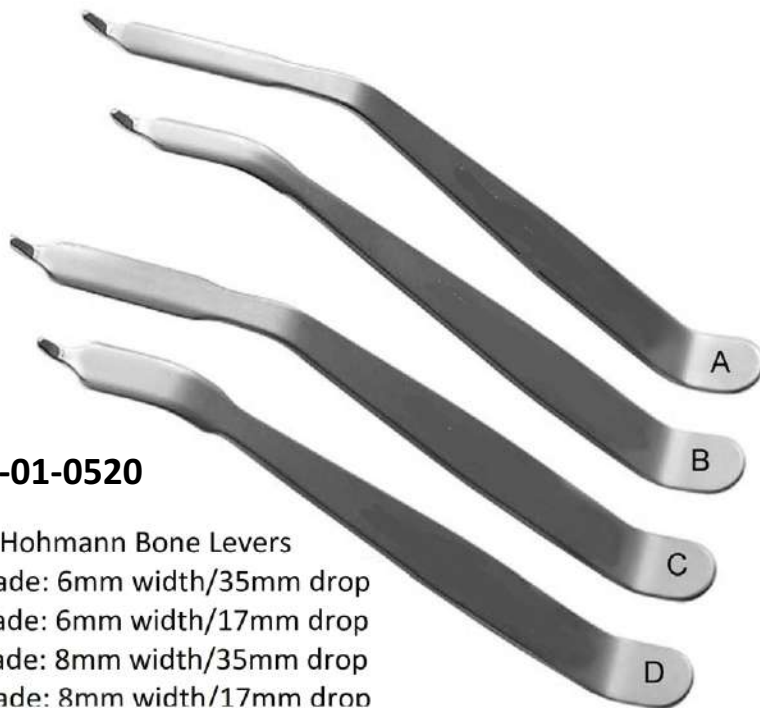

**MD-11-01-0520**

Mini Hohmann Bone Levers

- A:** Blade: 6mm width/35mm drop
- B:** Blade: 6mm width/17mm drop
- C:** Blade: 8mm width/35mm drop
- D:** Blade: 8mm width/17mm drop

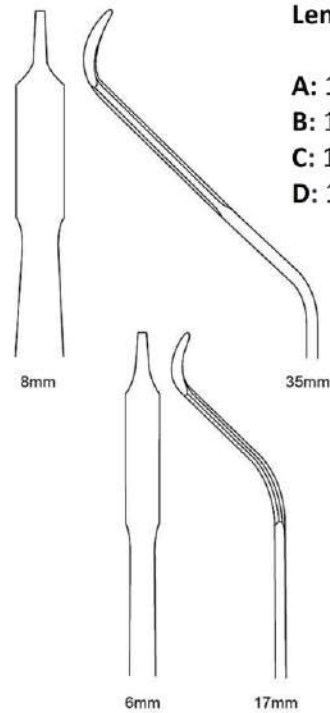

**Length:**

- A:** 15cm / 6"
- B:** 15.5cm/6 ¼"
- C:** 15cm/6"
- D:** 15.5cm/6 ¼"

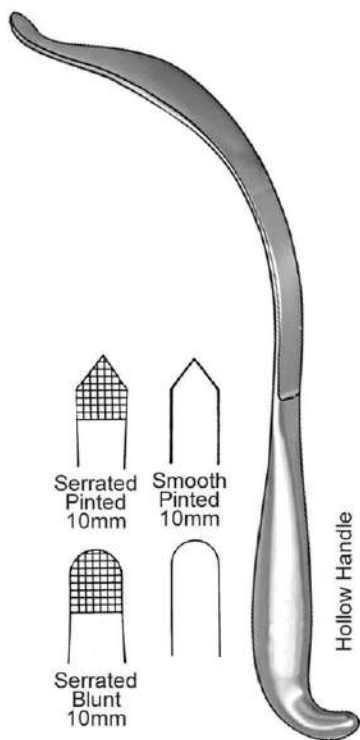

**MD-11-01-0521**  
Aufranc Cobra Retractor  
26 cm / 10 ½"

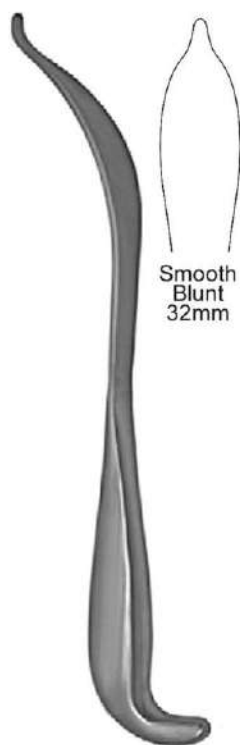

**MD-11-01-0522**  
Aufranc Cobra Retractor  
27.5cm / 11"

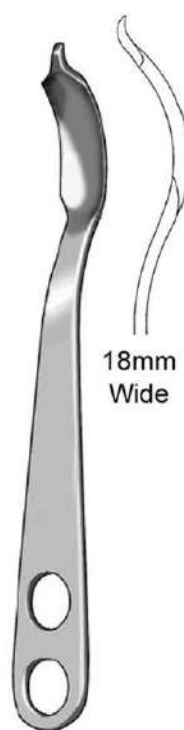

**MD-11-01-0523**  
Humeral Head Retractor  
23 cm / 9"

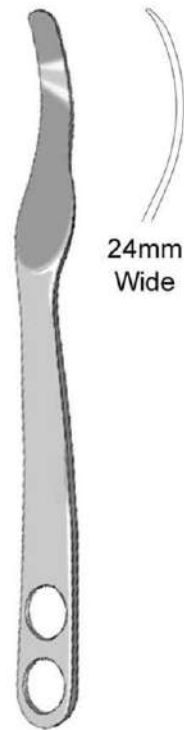

**MD-11-01-0524**  
Pelvic Retractor Single Prong  
26 cm / 10 ½"

## BONE LEVERS - RETRACTORS



**MD-11-01-0525**

Ribbon Retractor Malleable  
30 cm / 12"

### AVAILABLE SIZES:

- |                         |                      |                      |
|-------------------------|----------------------|----------------------|
| <b>A:</b> 6" X 6mm      | <b>G:</b> 8" X 10mm  | <b>M:</b> 13" X 38mm |
| <b>B:</b> 6" X 12mm     | <b>H:</b> 8" X 12mm  | <b>N:</b> 13" X 45mm |
| <b>C:</b> 6" X 16mm     | <b>I:</b> 8" X 16mm  | <b>O:</b> 13" X 50mm |
| <b>D:</b> 6" X 19mm     | <b>J:</b> 8" X 19mm  | <b>P:</b> 13" X 65mm |
| <b>E:</b> 7 1/2" X 25mm | <b>K:</b> 13" X 19mm | <b>Q:</b> 13" X 75mm |
| <b>F:</b> 8" X 6mm      | <b>L:</b> 13" X 30mm |                      |



**MD-11-01-0526**

Murphy Bone Skid  
30 cm / 12"

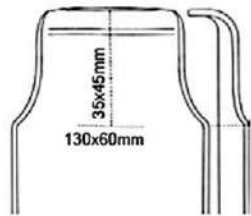

**A:** 29cm / 11 1/2" With Lip

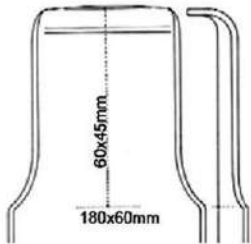

**B:** 33cm / 13" With Lip

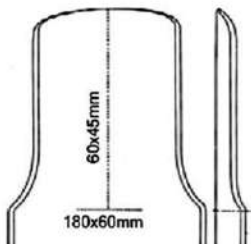

**C:** 33cm / 13" Without Lip



**MD-11-01-0527**

St. Mark's Pelvic Retractor  
Angled Blade

- A:** 22mm Blade  
2 Finger Rings Long Round
- B:** 22mm Blade  
1 Finger Ring Short Round

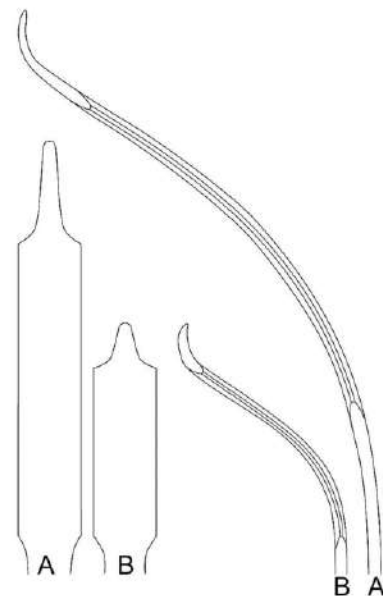
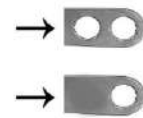

**MD-11-01-0528**

Hohmann Retractor  
40cm / 16"



BONE LEVERS - RETRACTORS

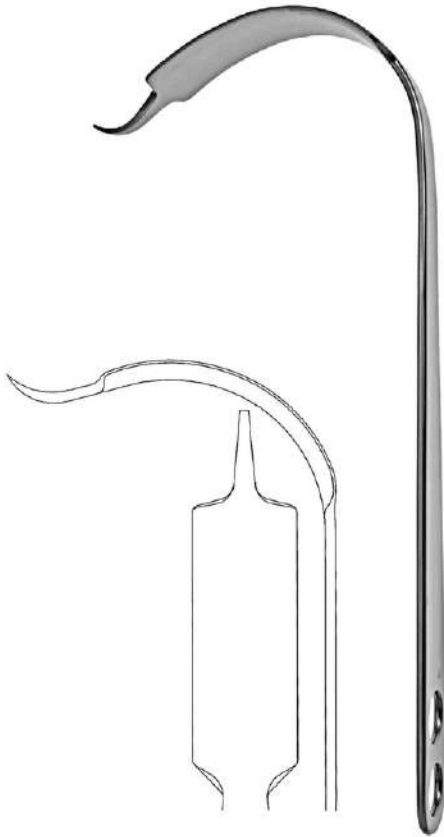

**MD-11-01-0529**  
Hohmann Retractor  
33 cm / 13"



**MD-11-01-0530**  
Virchow Skull Breaker  
7.5 cm / 3" 40 mm Blade Width

**MD-11-01-0531**

Buckley Chisel  
16cm / 6 1/4"  
Octagonal handle

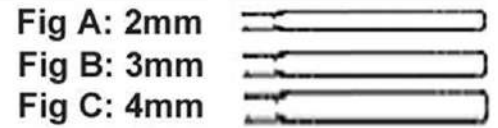

**MD-11-01-0532**

Buckley Gouge  
16cm / 6 1/4"  
Octagonal handle

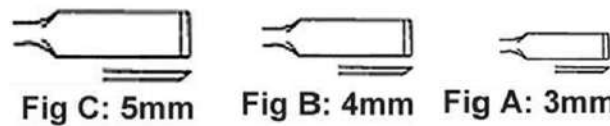
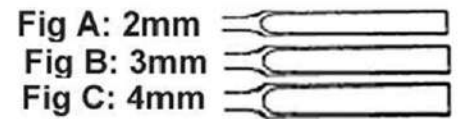

**MD-11-01-0533**

Stout Bone Chisel 21 cm / 8 1/4" octagonal handle



**MD-11-01-0534**

Bone Chisel 18 cm / 7" Round Handle

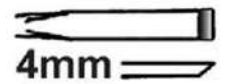

**MD-11-01-0535**

Bone Chisel 17 cm / 6 3/4" Round Handle

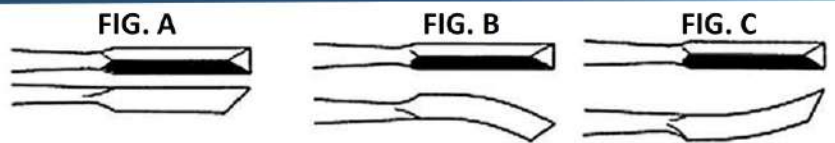
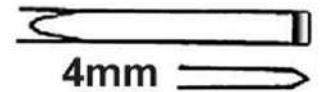

**MD-11-01-0536**

Gardner Bone Chisel 17 cm / 6 3/4" 4 mm



CHISELS - OSTEOTOMES - GOUGES

FIG A: 3 mm

FIG B: 5 mm



**MD-11-01-0537**

Snyder-O.S.U Bone Chisel 16.5 cm / 6 1/2" 3 mm / 5 mm

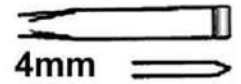

**MD-11-01-0538**

Bone Chisel 18 cm / 7" Octagonal Handle 4 mm

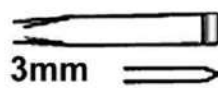

**MD-11-01-0539**

Bone Chisel 18 cm / 7" Octagonal Handle 3 mm



FIG A



FIG B



**MD-11-01-0540**

O.S.U. Bone Chisel 17 cm / 6 3/4" 7 mm / 9 mm

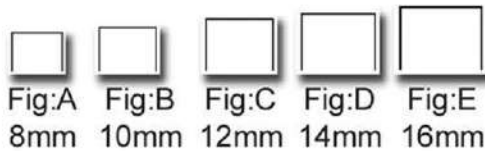

Fig:A 8mm Fig:B 10mm Fig:C 12mm Fig:D 14mm Fig:E 16mm

Side View



**MD-11-01-0541**

Osteotome 13.5 cm / 5 1/4"

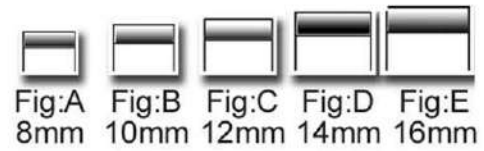

Fig:A 8mm Fig:B 10mm Fig:C 12mm Fig:D 14mm Fig:E 16mm

Side View



**MD-11-01-0542**

Chisel 13.5 cm / 5 1/4"

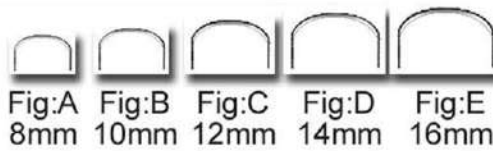

Fig:A 8mm Fig:B 10mm Fig:C 12mm Fig:D 14mm Fig:E 16mm

Side View



**MD-11-01-0543**

Gouge 13.5 cm / 5 1/4"

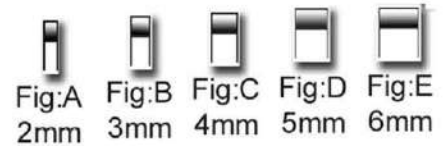

Fig:A 2mm Fig:B 3mm Fig:C 4mm Fig:D 5mm Fig:E 6mm

Side View



**MD-11-01-0544** Partsch Chisel 13.5 cm / 5 1/4"

**MD-11-01-0545** Partsch Chisel 17 cm / 6 3/4"



## CHISELS - OSTEOTOMES - GOUGES

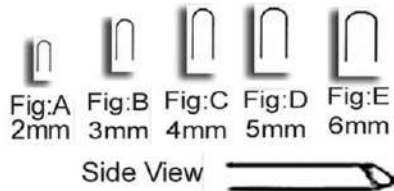

**MD-11-01-0546** Partsch Gouge 13.5 cm / 5 ¼"

**MD-11-01-0547** Partsch Gouge 13.5 cm / 5 ¼"

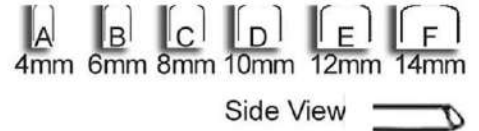

**MD-11-01-0548** Alexander Gouge 17.5 cm / 7"

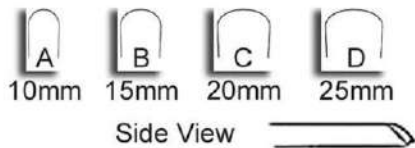

**MD-11-01-0549** Stille Gouge 20 cm / 8"

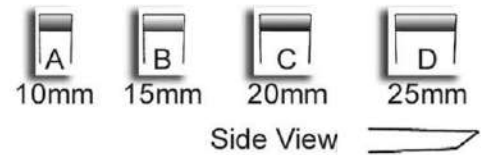

**MD-11-01-0550** Stille Chisel 20 cm / 8"

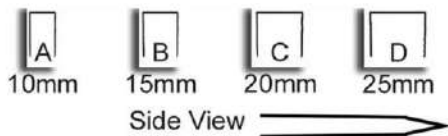

**MD-11-01-0551** Stille Osteotome 20 cm / 8"

**MD-11-01-0555**

Lambotte, Osteotome

24 cm / 9 ½"

Curved Tip



Side View  
Curved Tip



**Available in**

- 15mm
- 20mm
- 25mm
- 30mm
- 38mm
- 44mm
- 50mm

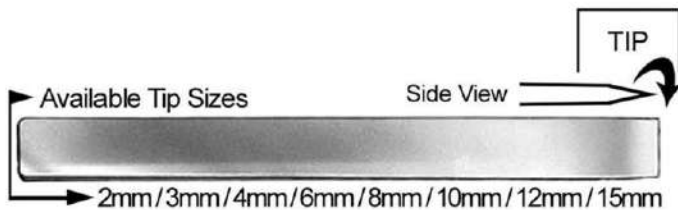

**MD-11-01-0552** (12.5 cm / 5") Lambotte, Mini Osteotome

**MD-11-01-0553** (17 cm / 6 ¾") Lambotte, Mini Osteotome  
3mm / 4mm / 6mm / 8mm / 10mm / 12mm / 15mm

**MD-11-01-0554** (24 cm / 9 ½") Lambotte, Osteotome  
15mm / 20mm / 25mm / 30mm / 38mm / 44mm / 50mm

CHISELS - OSTEOTOMES - GOUGES

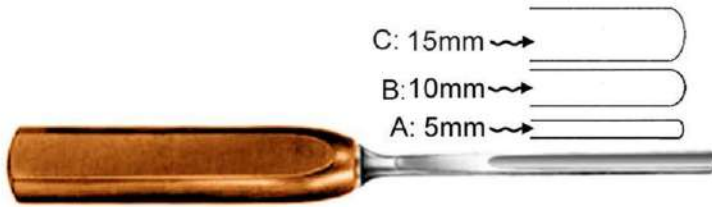

**MD-11-01-0556A**

Lexer Spongiosa Gouge (25 cm / 9 3/4")

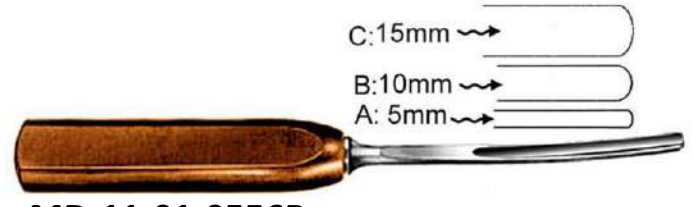

**MD-11-01-0556B**

Lexer Spongiosa Gouge (25 cm / 9 3/4")

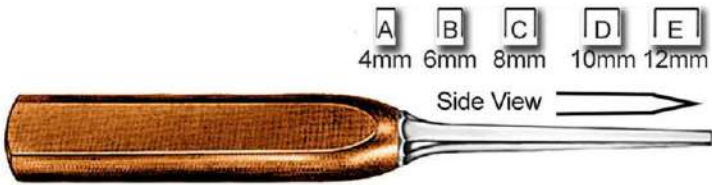

**MD-11-01-0557A**

Lexer, Mini Osteotome 18.5 cm / 7 1/4"

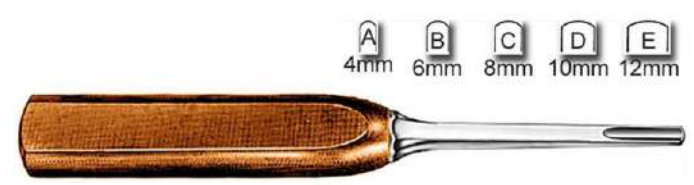

**MD-11-01-0557B**

Lexer, Mini Osteotome 18.5 cm / 7 1/4"

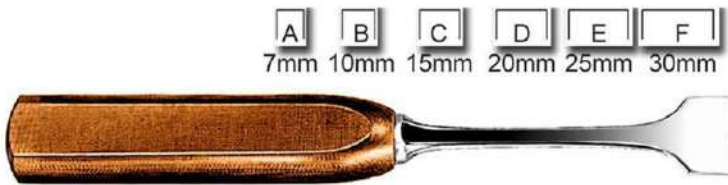

**MD-11-01-0558A**

Lexer, Osteotome 22 cm / 8 3/4"

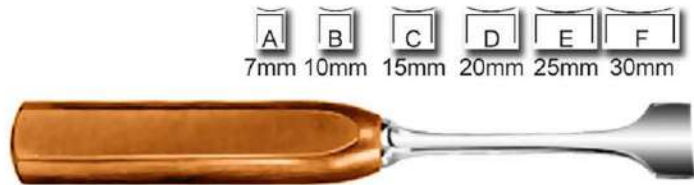

**MD-11-01-0558B**

Lexer, Osteotome 22 cm / 8 3/4"



**MD-11-01-0559**

Vickers Spongiosa Gouge 18 cm / 7"



**MD-11-01-0560A**

US Army Chisel 18 cm / 7"



**MD-11-01-0560B**

US Army Osteotome 18 cm / 7"



**MD-11-01-0560C**

US Army Gouge 18 cm / 7"



**MD-11-01-0561A**

Smith-Petersen Osteotome 20.5 cm / 8" Straight



**MD-11-01-0561B**

Smith-Petersen Osteotome 20.5 cm / 8" Curved



CHISELS - OSTEOTOMES - GOUGES

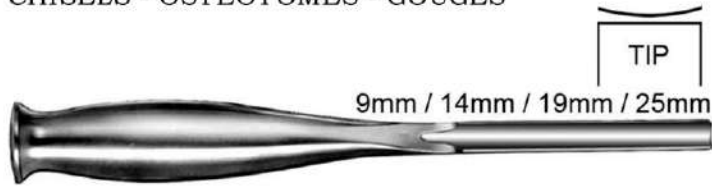

**MD-11-01-0561C**

Smith-Petersen Gouge 20.5 cm / 8" Straight Tip

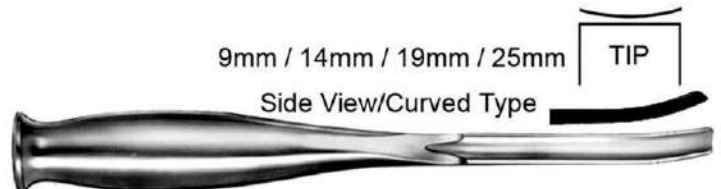

**MD-11-01-0561D**

Smith-Petersen Gouge 20.5 cm / 8" Curved Tip



**MD-11-01-0562**

Hook Osteotome 17 cm / 6 3/4"

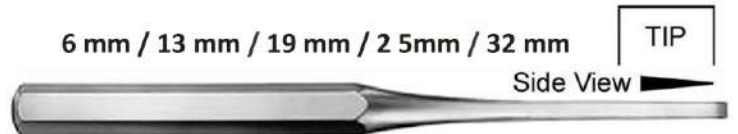

**MD-11-01-0563A**

Hibbs Osteotome 24.5 cm / 9 3/4"

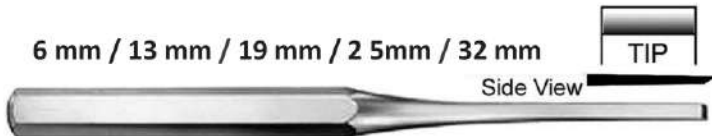

**MD-11-01-0563B**

Hibbs Chisel 24.5 cm / 9 3/4"



**MD-11-01-0563C**

Hibbs Gouge 24.5 cm / 9 3/4"

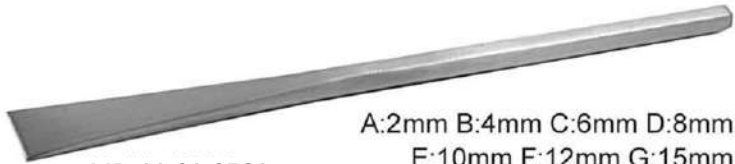

**MD-11-01-0564**

Sheehan Osteotome 16cm / 6 1/2"



**MD-11-01-0565A**

Silver Osteotome 18 cm / 7" Straight



**MD-11-01-0565B**

Silver Osteotome 18 cm / 7" Curved Right



**MD-11-01-0565C**

Silver Osteotome 18 cm / 7" Curved Left



**MD-11-01-0566**

Shoulder Penetrating Gouge 21 cm / 8 1/2"

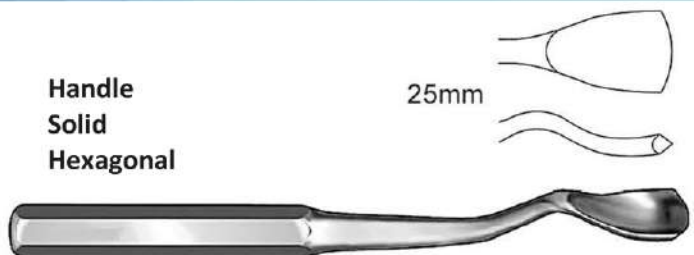

**MD-11-01-0567**

Swan Neck Gouge 23 cm / 9"

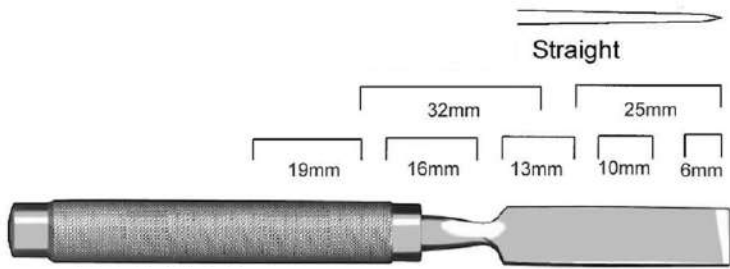

**MD-11-01-0568A**

Cobb Osteotome 28 cm / 11" Straight

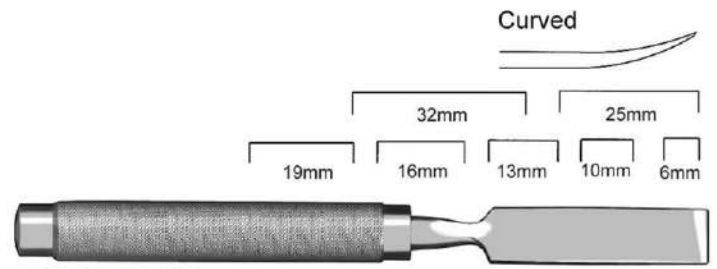

**MD-11-01-0568A**

Cobb Osteotome 28 cm / 11" Curved

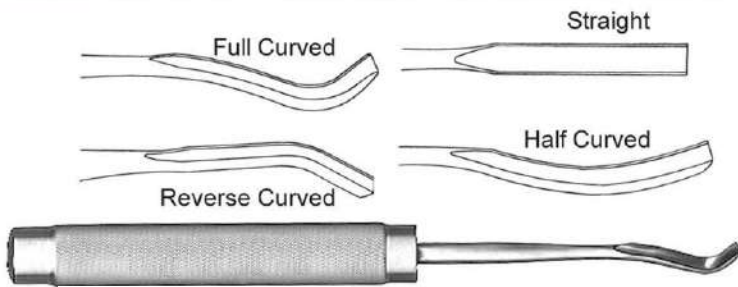

**MD-11-01-0569**

Cobb Gouge 28 cm / 11"

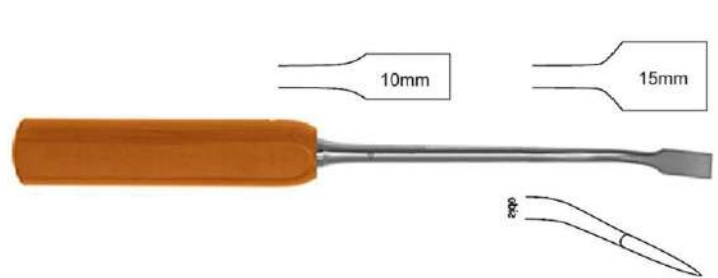

**MD-11-01-0570**

Lexer Osteotome Angled / 28 cm / 11"

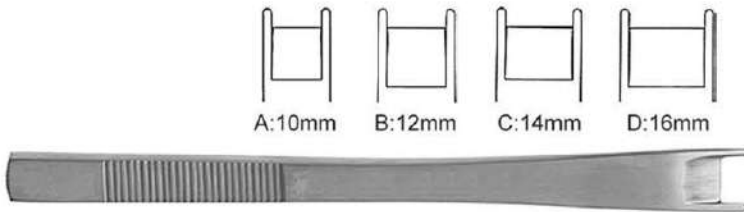

**MD-11-01-0571**

Cinelli Osteotome 15.5 cm / 6 1/2"

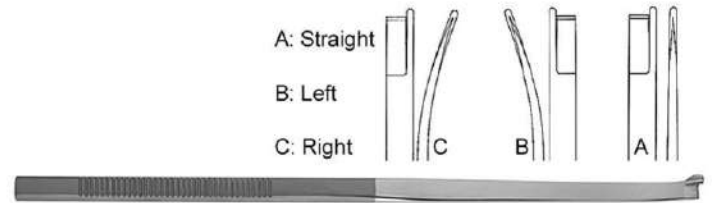

**MD-11-01-0572**

Anderson Neivert Osteotome 20 cm / 8"

**MD-11-01-0573**

Hibbs Osteotome 47 cm / 18 1/2" 10 mm Tip  
3 1/2" Tip L / 10 3/4" Shaft L / 4 1/4" Handle L  
11.5 mm Shaft Diameter

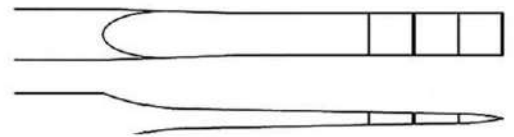

**MD-11-01-0574**

Hibbs Gouge 47 cm / 18 1/2" 10 mm Tip  
3 1/2" Tip L / 10 3/4" Shaft L / 4 1/4" Handle L  
11.5 mm Shaft Diameter

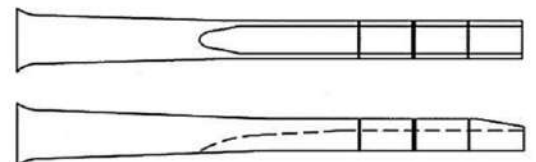

CHISELS - OSTEOTOMES - GOUGES



**MD-11-01-0575**

Spinal Fusion Gouge 24 cm / 9 1/2" 6 mm Tip

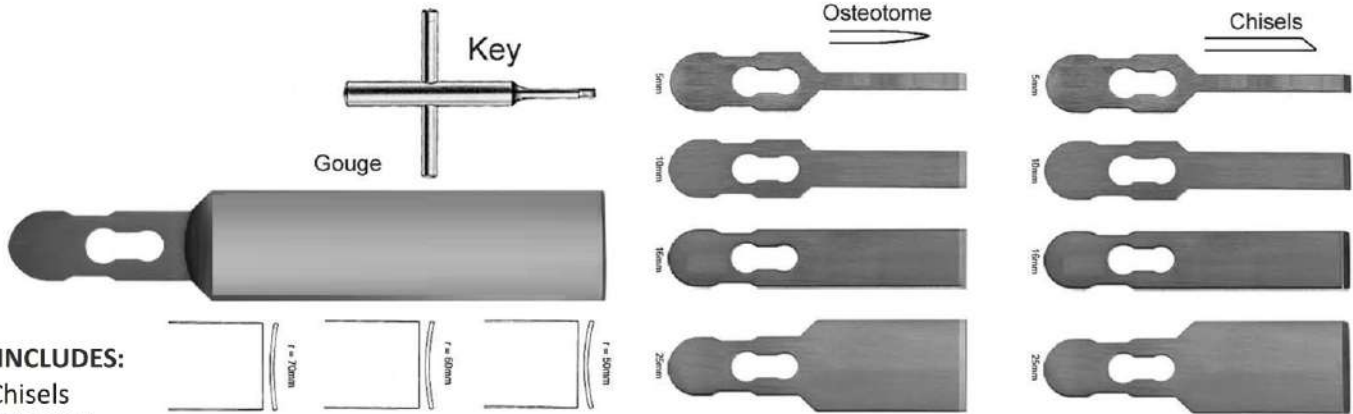

**SET INCLUDES:**

- 5 x Chisels
- 5/10/15/25mm
- 5 x Osteotomes
- 5/10/15/25mm
- 3 x Gouges
- 50/60/70mm Radius
- 1 x Handle Fibre
- 1 x Key



**MD-11-01-0576**

Chisel Handle Fibre w/Chisel-Osteotome-Gouge Blades 18.5 cm / 7 1/4"

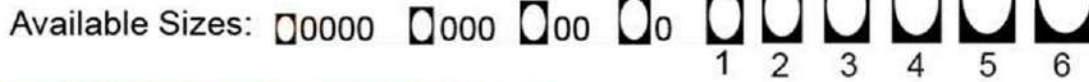

**MD-11-01-0577**

Volkman Bone Curette 18.5 cm / 7 1/4" oval with plastic handle

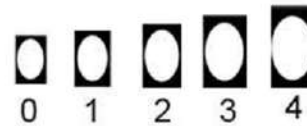

**MD-11-01-0578**

Volkman Bone Curette 27.5 cm / 10 3/4" oval with plastic handle

## BONE CURETTES

A: 13 cm / 5"  
B: 16 cm / 6 ¼"  
C: 20 cm / 8"

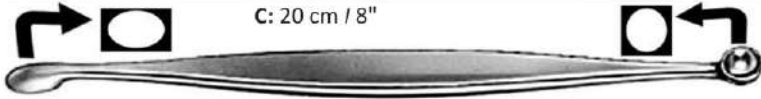

**MD-11-01-0579**

Volkman Bone Curette, double-ended (oval / round)



**MD-11-01-0580**

Bone Curette, double-ended (round / oval) 21 cm / 8 ¼"



**MD-11-01-0581**

Schede Bone Curette 17 cm / 6 ¾" oval with hollow handle

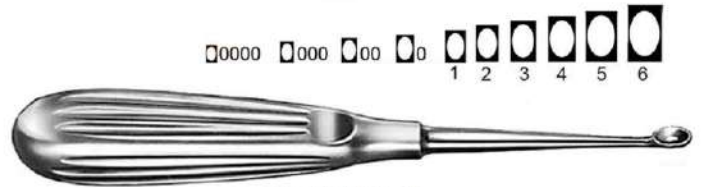

**MD-11-01-0582**

Volkman Bone Curette 17 cm / 6 ¾" oval, with hollow

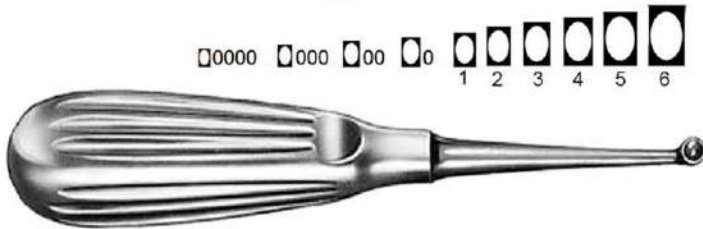

**MD-11-01-0583**

Bruns Bone Curette 17 cm / 6 ¾" Round, with hollow handle

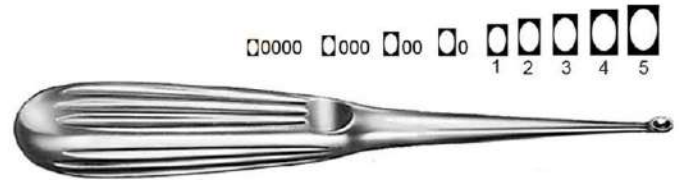

**MD-11-01-0584**

Spratt Bone Curette 17 cm / 6 ¾" Oval, with hollow handle

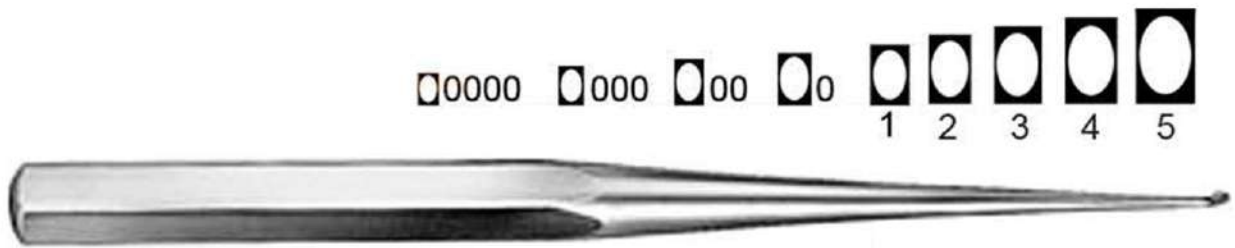

**MD-11-01-0585**

Bruns Bone Curette 23 cm / 9" oval, solid



**MD-11-01-0586**

Scoville Bone Curette 25 cm / 9 ¾" oval, with hollow handle

## BONE CURETTES



**MD-11-01-0587**

Simon Bone Curette 25 cm / 9 3/4" oval, with hollow handle



**MD-11-01-0588**

Modell USA Bone Curette 16 cm / 6 1/4" Oval, with hollow handle



**MD-11-01-0589**

Modell USA Bone Curette 15.5 cm / 6" Oval, with hollow handle



**MD-11-01-0590**

Model USA Bone Curette 15.5 cm / 6" Oval, with hollow handle

## BONE CURETTES

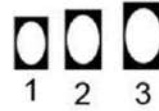

**MD-11-01-0591**

Halle Bone Curette 21 cm / 8 1/4" oval, malleable shaft, with hollow handle

A: 00/0 ●/● B: 0/1 ●/● C: 1/2 ●/●

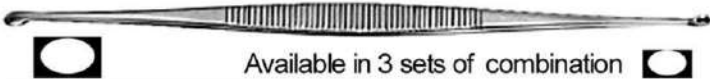

Available in 3 sets of combination

**MD-11-01-0592**

Williger Bone Curette, double-ended 13.5 cm / 5 1/4" handle



A: 00/00 ●/● B: 0/0 ●/● C: 1/1 ●/●

**MD-11-01-0593**

Williger Bone Curette, 17 cm / 6 3/4" double-ended oval / oval



A: 12.5 cm / 5"  
B: 14.5 cm / 5 3/4"  
C: 17 cm / 6 3/4"

**MD-11-01-0594**

Volkman Bone Curette, double-ended



A: 1 R/L ●/● B: 2 R/L ●/● C: 3 R/L ●/●

**MD-11-01-0595**

Hemingway-Martin Bone Curette, double-ended  
18.5 cm / 7 1/4"



**MD-11-01-0596**

Bone Curette, 17.5 cm / 7" double-ended round

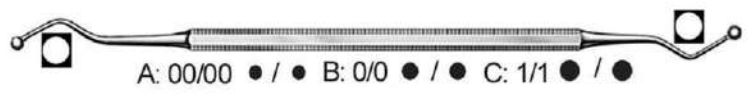

A: 00/00 ●/● B: 0/0 ●/● C: 1/1 ●/●

**MD-11-01-0597**

Hemingway Bone Curette, double-ended, round / round  
18.5 cm / 7 1/4" octagonal handle

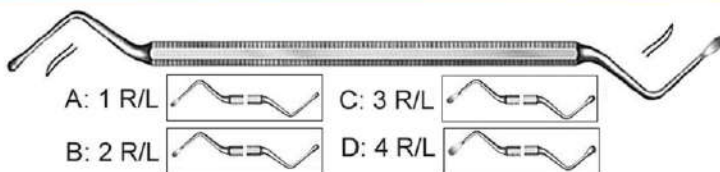

A: 1 R/L C: 3 R/L  
B: 2 R/L D: 4 R/L

**MD-11-01-0598**

Lucas Bone Curette, double-ended 18 cm / 7"  
Octagonal handle

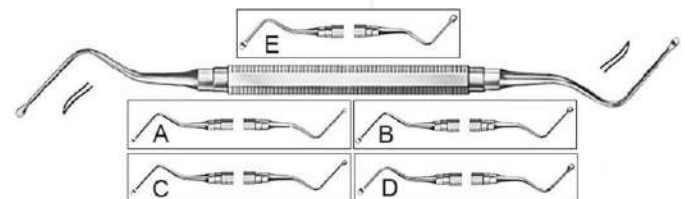

**MD-11-01-0699**

Miller-Colburn Bone Curette, double-ended 17 cm / 6 3/4"

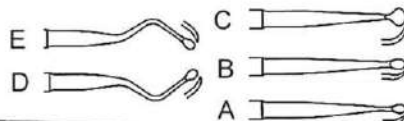
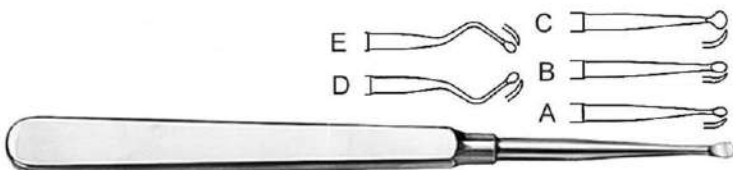

**MD-11-01-0600**

Molt Bone Curette 17 cm / 6 3/4"

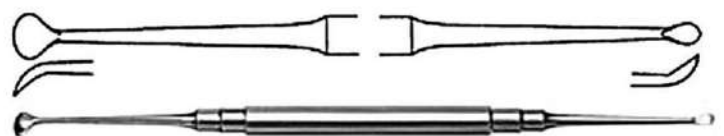

**MD-11-01-0601**

Molt Bone Curette 19 cm / 7 1/2" Round Handle





## BONE CURETTES

Hollow Handle  
Oval Fenestrated  
4X7mm Cup  
Sharp/Blunt

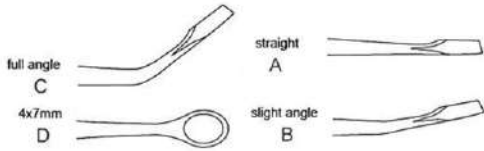

**MD-11-01-0602**

Semmes Ring Curette 23 cm / 9"

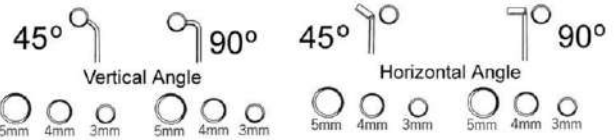

**MD-11-01-0603**

Ray Pituitary Curette 18 cm / 7 1/2"

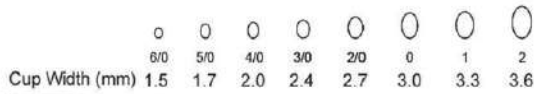

Hollow Handle

Str-Oval Cup

**MD-11-01-0604**

Lempert Curette 18 cm / 7 1/2"

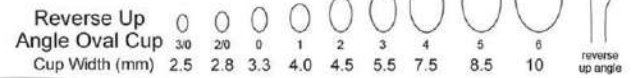

Hollow Handle

**MD-11-01-0605**

Epstein Curette 18 cm / 7 1/2"

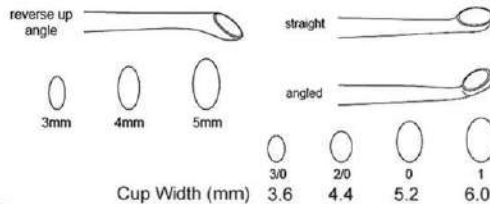

Hollow Handle

**MD-11-01-0606**

Bushe Curette 25 cm / 10"

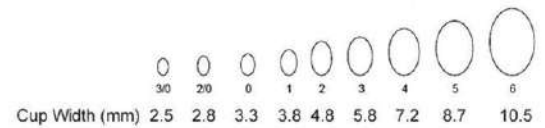

Solid Handle

Str-Oval Cup

**MD-11-01-0607**

Spinal Fusion Curette 28 cm / 11"

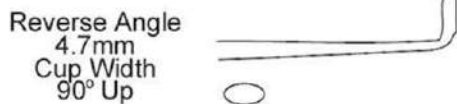

**MD-11-01-0608**

Scoville Curette 25 cm / 10"

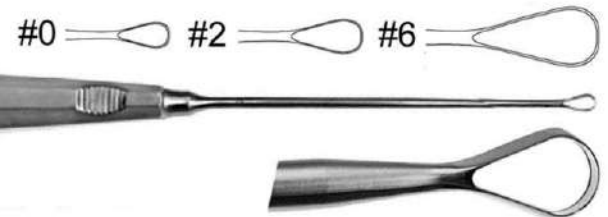

**MD-11-01-0609**

Ring Curette

- A: 25 cm / 10" #0 6mm Cup
- B: 25 cm / 10" #2 8mm Cup
- C: 26 cm / 10 1/2" #6 14mm Cup
- D: 28 cm / 11 1/2" #0 6mm Cup
- E: 28 cm / 11 1/2" #2 8mm Cup
- F: 30 cm / 12 1/2" #6 14mm Cup



## BONE CURETTES

Cup Size  
 2.8mm  
 3.3mm  
 3.6mm  
 4.3mm  
 4.8mm  
 5.6mm  
 6.0mm  
 6.7mm  
 8.8mm

straight angled  
 straight angled  
 straight angled

**MD-11-01-0610**  
Cobb Curette Oval Cups  
28 cm / 11"

Cup Size  
 2.8mm  
 3.3mm  
 3.6mm  
 4.3mm  
 4.8mm  
 5.6mm  
 6.0mm  
 6.7mm  
 8.8mm

straight angled  
 straight angled  
 straight angled

**MD-11-01-0611**  
Cobb Curette Oval Cups  
28 cm / 11"

straight angled angled blunt  
 straight angled angled blunt  
 straight angled angled blunt  
 straight angled angled blunt

straight	#4/0	cup width	2.8mm
15°	#3/0		3.6mm
15°	#0		5.2mm
15°	#3		10.0mm
16°	#3/0		3.6mm
16°	#2/0		4.4mm
16°	#0		5.2mm
angled	#4/0		2.8mm
15°	#3/0		3.6mm
15°	#0		5.2mm
15°	#3		10.0mm
16°	#3/0		3.6mm
16°	#2/0		4.4mm
16°	#0		5.2mm
angled shaft	16 1/2° #4/0		2.8mm
	16 1/2° #3/0		3.6mm

**MD-11-01-0612**  
Sybert Curette Long  
Delicate Shaft

Straight Angled Shaft  
 3mm  
 6mm  
 8mm

**MD-11-01-0613**  
Cone Ring Curette  
23 cm / 9"

- A: Straight 8mm Sharp/Blunt
- B: Straight 11 mm Sharp/Blunt
- C: Angled 8mm Sharp/Sharp
- D: Angled 11 mm Sharp/Sharp
- E: Angled 8mm Sharp/Sharp Right Cvd

- F: Angled 11 mm Sharp/Sharp Right Cvd
- G: Angled 8mm Sharp/Sharp Left Cvd
- H: Angled 11 mm Sharp/Sharp Left Cvd

**MD-11-01-0614**  
Zielke Ring Curette 34 cm / 13 1/2" TEFLON Handle

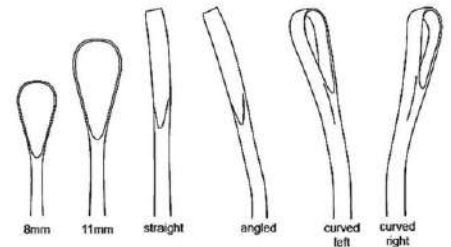

17" Angled 40° 3mm Diameter 2.7"  
Tip Length Cone Ring Curette  
Endoscopic Fibre Handle 9.3" Shaft  
Length 5" Handle Length .285 (7  
.2mm) Shaft Diameter

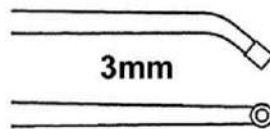

20" Angled 30°  
6mm Diameter  
3 1/2" Tip Length  
10" Shaft Length  
6 1/2" Handle Length  
45" (11 .5mm)  
Shaft Diameter

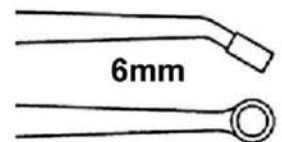

**MD-11-01-0615**  
Cone Ring Curette Endoscopic Fibre Handle



## BONE CURETTES

17" Reverse Angled 40° 3mm x 6mm cup  
2.7" Tip Length 9.3" Shaft Length 5" Handle  
Length .285 (7.2mm) Shaft Diameter

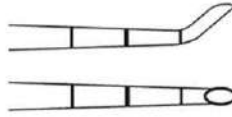

20" Reverse Angled 30°  
6mm x 9mm cup 3 1/2"  
Tip Length 10" Shaft  
Length 6 1/2" Handle  
Length .45 (7.2mm)  
Shaft Diameter

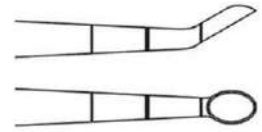

### MD-11-01-0616

Epstein Curette Endoscopic Fibre Handle

A: 17cm / 6 3/4" 8mm | B: 19cm / 7 1/2" 16 mm | E: 18.5cm / 7" 12 mm  
C: 19cm / 7 1/2" 16 mm | D: 18.5cm / 7 1/4" 12 mm

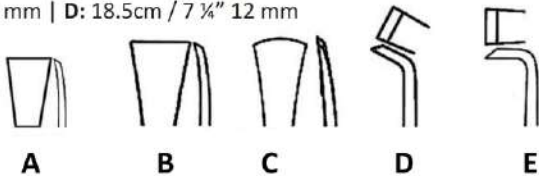

### MD-11-01-0617

Martin-Langenbeck Periosteal Elevator (Solid)

B: 18.5cm / 7 1/4" 15mm tip  
C: 19cm / 7 1/2" 20 mm tip  
A: 16cm / 6 1/4" 7mm

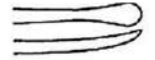
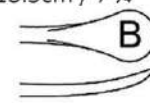
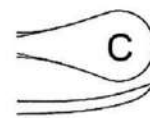

### MD-11-01-0618

Martin-Langenbeck Periosteal Elevator (Solid)

A: 17.5cm / 7"  
4mm tip  
C: 7mm  
19.5cm / 7 3/4"  
6mm tip  
B: 17.5cm / 7"  
5mm tip  
C: 6mm



### MD-11-01-0619

Martin-Langenbeck Periosteal Elevator (Solid)



### MD-11-01-0620

Langenbeck Periosteal Elevator 18.5 cm / 7 1/4"  
With hollow handle



### MD-11-01-0621

Langenbeck Periosteal Elevator 19.5 cm / 7 3/4"  
With hollow handle



### MD-11-01-0622

Periosteal Elevator 16 cm / 6 1/4" Delicate, solid

## PERIOSTEAL ELEVATORS



**MD-11-01-0623**

Farabeuf Periosteal Elevator 15 cm / 6"  
With hollow handle



**MD-11-01-0624**

Periosteal Elevator 3mm Tip 18 cm / 7"  
Extra narrow, with plastic handle

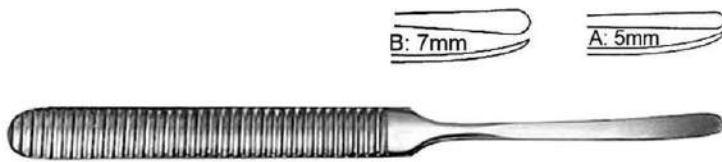

**MD-11-01-0625**

Kahre-Williger 16 cm / 6 1/4"  
Periosteal Elevator solid



**MD-11-01-0626**

Kahre-Williger Periosteal Elevator solid  
16cm / 6 1/4"



**MD-11-01-0627**

Farabeuf Periosteal Elevator  
15 cm / 6" with hollow handle



**MD-11-01-0628**

Sedillot Periosteal Elevator 22 cm / 8 3/4" (15mm tip)



**MD-11-01-0629**

Periosteal Elevator 20 cm / 8" (14 mm Tip)  
With plastic handle



**MD-11-01-0630**

Periosteal Elevator 19 cm / 7 1/2"  
(14 mm Tip) with plastic handle



**MD-11-01-0631**

Periosteal Elevator 6mm Tip  
18 cm / 7" narrow, plastic handle



**MD-11-01-0632**

Periosteal Elevator 18 cm / 7" narrow,  
Plastic handle (6mm Tip)



PERIOSTEAL ELEVATORS - DISSECTORS



**MD-11-01-0633**  
Williger Periosteal Elevator  
12.5 cm / 5" solid 5mm Tip



**MD-11-01-0634**  
Periosteal Elevator,  
Double ended 17.5 cm / 7"

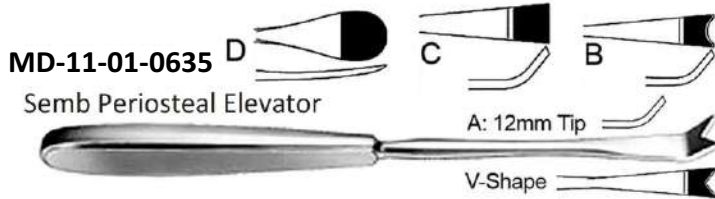

**MD-11-01-0635**  
Semb Periosteal Elevator  
A: 12mm Tip  
V-Shape  
A+D: 21cm / 8 1/4" & B+C: 18.5 cm / 7 1/4"  
A: V-shape 12mm | B: Inside round 12mm  
C: Straight 13mm | D: Outer round 15mm

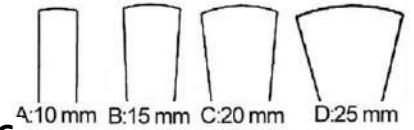

**MD-11-01-0636**  
11-01-0636  
Lambotte Periosteal Elevator 21.5 cm / 8 1/2"



**MD-11-01-0637**  
Periosteal Elevator 20 cm / 8" with plastic handle



**MD-11-01-0638**  
Periosteal Elevator 17 cm / 6 3/4" with hollow handle

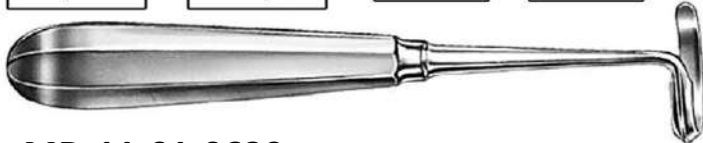
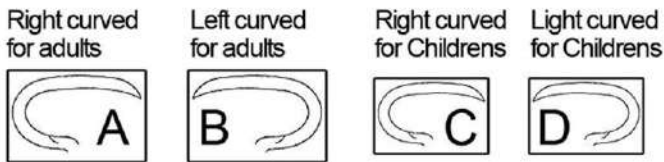

**MD-11-01-0639**  
Doyen Rib Raspatorary 17.5 cm / 7" Rib Raspatories with hollow handle

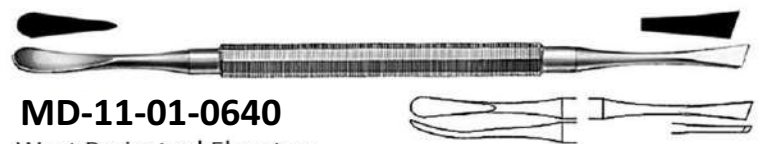

**MD-11-01-0640**  
West Periosteal Elevator,  
Double-ended 18.5 cm / 7 1/4" octagonal handle



**MD-11-01-0641**  
Williger Elevator  
17 cm / 6 3/4" 7mm tip



**MD-11-01-0643**  
Elevator 17 cm / 6 3/4" Light weight



**MD-11-01-0642**  
Williger Elevator  
16 cm / 6 1/4" (5.5mm tip)

PERIOSTEAL ELEVATORS - DISSECTORS

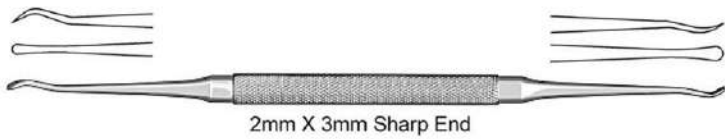

**MD-11-01-0644**  
Kleinert Kutz Elevator 14 cm / 5 1/2"



**MD-11-01-0645**  
Vickers Dissector 17 cm / 6 3/4"

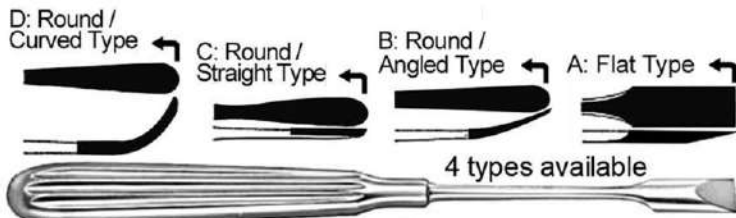

**MD-11-01-0646**  
Adson Elevator 17.5 cm / 7" A/B/C/D

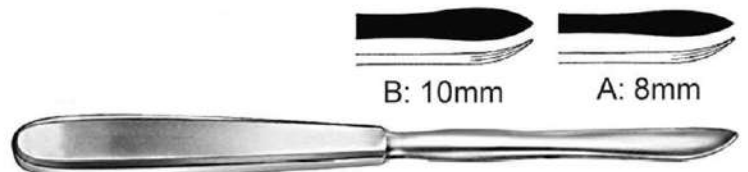

**MD-11-01-0647**  
Langenbeck Elevator 19.5 cm / 7 3/4" A/B

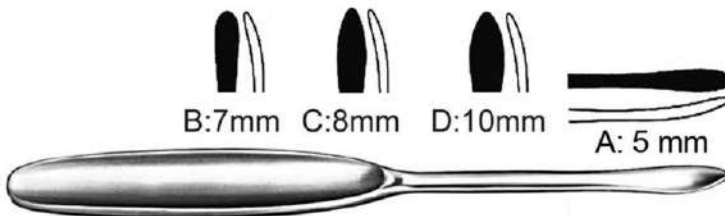

**MD-11-01-0648**  
Martin Langenbeck Elevator 17 cm / 6 3/4" A/B/C | D: 19.5 cm / 7 3/4"



**MD-11-01-0649**  
Phalangeal Elevator 16cm / 6 1/4"



**MD-11-01-0650**  
Alderdyce Dissector, double-ended 21 cm / 8 1/4"

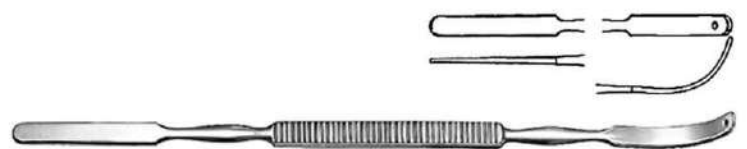

**MD-11-01-0651**  
McDonald Dissector, double-ended 18.5 cm / 7 1/4"

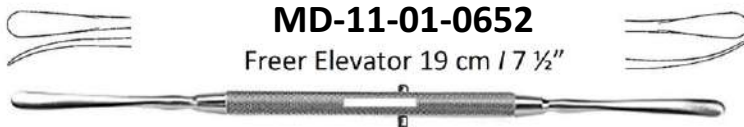

**MD-11-01-0652**  
Freer Elevator 19 cm / 7 1/2"



**MD-11-01-0653**  
Penfield Elevator Endoscopic 38 cm / 15" 5mm Semi Sharp / 1X10mm Blunt Hook



**MD-11-01-0654**  
Smithwick Hook and Dissector 30 cm / 12" 5mm Semi Sharp / 1X10mm Blunt Hook

PERIOSTEAL ELEVATORS - RESPIRATORIES

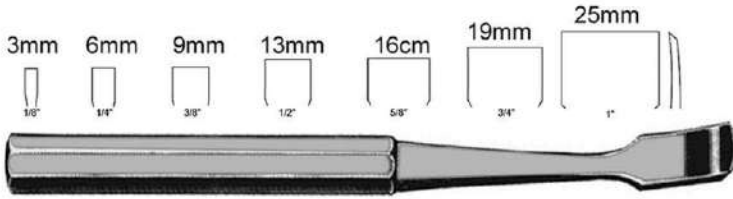

**MD-11-01-0655**

Key Elevator 19 cm / 7 ½" Sharp Edge

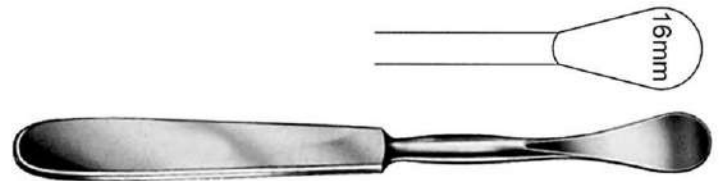

**MD-11-01-0656**

Sedilot Elevator 18 cm / 7" Sharp Edge



**MD-11-01-0657**

Alexander Periosteal Respiratory 20 cm / 8" / 12mm Sharp

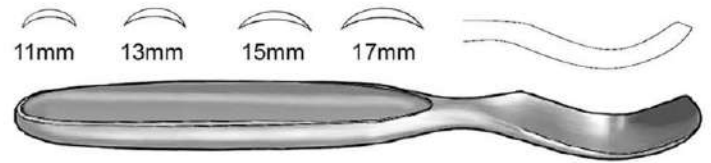

**MD-11-01-0658**

McGiamry Metatarsal Elevator 16 cm / 6 ½" Sharp

- A: 19cm / 7 ½" 13mm
- B: 20cm / 8" 19mm
- C: 23cm / 9" 25mm
- D: 25.5cm / 10" 30mm

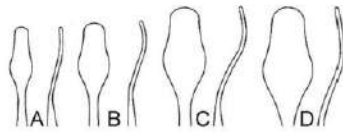

**MD-11-01-0659**

Chandler Elevator Blunt



**MD-11-01-0660**

Sayre Elevator 16 cm / 6 ½"  
A: Sharp / Blunt B: Blunt/ Blunt

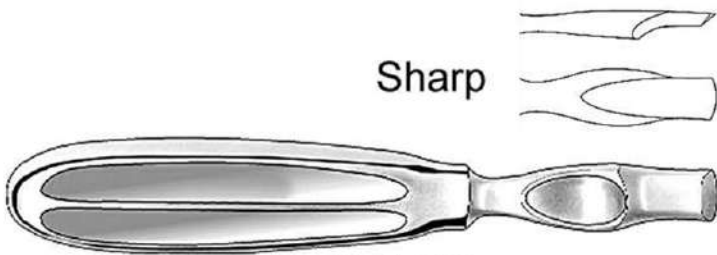

**MD-11-01-0661**

Kirmission Periosteal Respiratory 17 cm / 6 ¾"

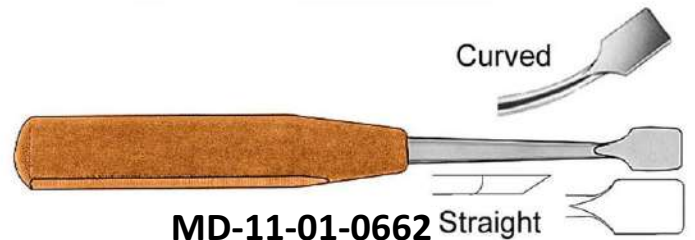

**MD-11-01-0662**

Periosteal Elevator 17cm / 6 ¾" Fibre Handle  
13mm Blade Sharp

- A: 14mm Full Curves
- B: 14mm Slight Curves
- C: 7mm Full Curves
- D: 7mm Slight Curves

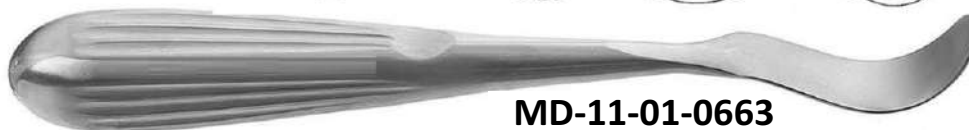
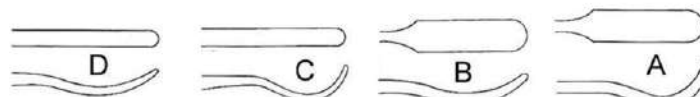

**MD-11-01-0663**

Crego Periosteal Elevator 19 cm / 7 ¾" Sharp

PERIOSTEAL ELEVATORS - DISSECTORS

**Small**

A: 26 cm / 10 1/4" 13mm Width at Tip

**Medium**

B: 26 cm / 10 1/4" 20mm Width at Tip

**Large**

C: 35 cm / 13 3/4" 25mm Width at Tip

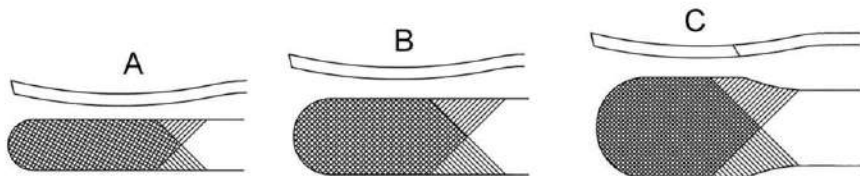

**MD-11-01-0664**  
Darraeh Elevator Blunt

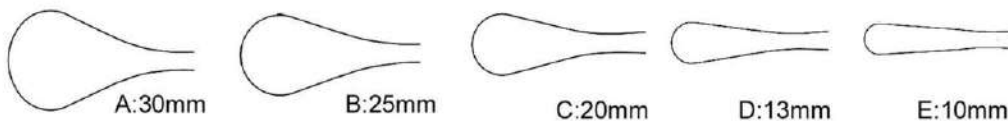

**MD-11-01-0665**  
Cobb Spinal Elevator Sharp 24cm / 9 1/2" Hexa Handle

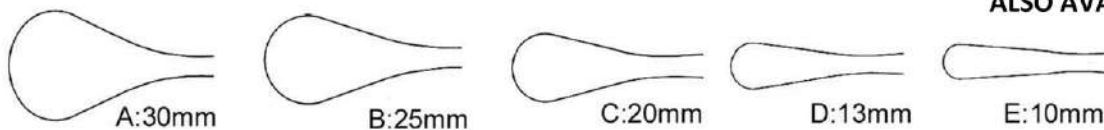

**ALSO AVAILABLE WITH FIBRE HANDLE**



**MD-11-01-0666**  
Spinal Elevator Sharp 28 cm / 11" Knurled Handle

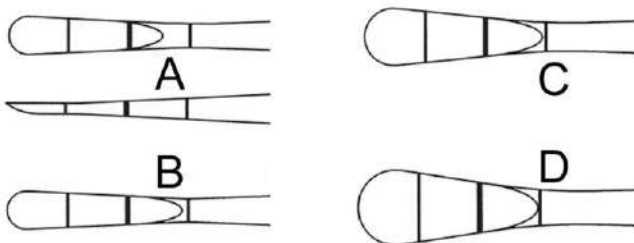

<b>A:</b> 43cm / 17" 6mm Tip Width 2.7" Tip Length 9.3" Shaft Length 5" Handle Length 7.2mm Shaft Dia	<b>B:</b> 50cm / 20" 6mm Tip Width 3 1/2" Tip Length 10" Shaft Length 6 1/2" Handle L 11.5mm Shaft Dia	<b>C:</b> 50cm / 20" 10mm Tip Width 3 1/2" Tip Length 10" Shaft Length 6 1/2" Handle L 11.5mm Shaft Dia	<b>D:</b> 50cm / 20" 13mm Tip Width 3 1/2" Tip Length 10" Shaft Length 6 1/2" Handle L 11.5mm Shaft Dia
--	---	--	--



**MD-11-01-0667**  
Cobb Elevator Endoscopic Sharp / Fibre Handle



ELEVATORS SPINAL – S/S & FIBRE

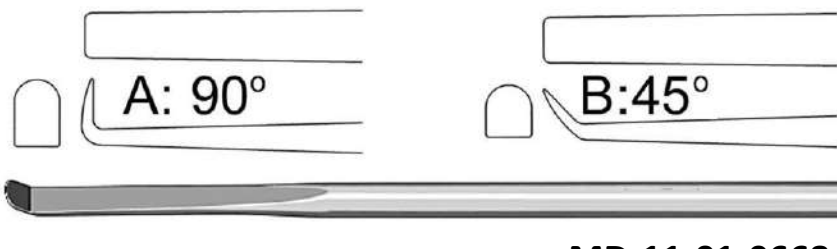

43 cm / 17" - 9mm Tip Radius - 4" Tip Length  
8" Shaft Length - 5" Handle Length  
11 .5mm Shaft Diameter

**MD-11-01-0668**

Rib Elevator Endoscopic Sharp / Fibre Handle

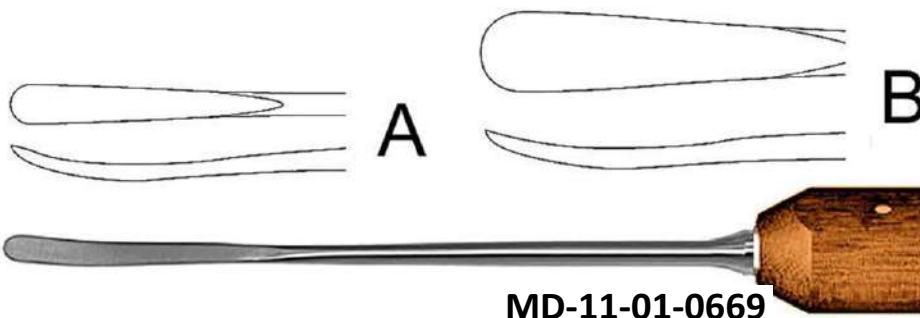

A: 8mm Wide  
B: 17mm Wide

**MD-11-01-0669**

Wagner Elevator Sharp / Fibre Handle 33 cm / 13"



A: 19mm  $\varnothing$  / 230 gms  
B: 25mm  $\varnothing$  / 260 gms

**MD-11-01-0670**

Lucae Mallet 19.5 cm / 7 3/4"



**MD-11-01-0671**

Cottle Mallet Plane / Convex  
19 cm / 7 1/2" 30mm  $\varnothing$  / 300 gms



**MD-11-01-0672**

Williger Mallet 16.4cm / 6 1/2"  
20 mm  $\varnothing$  / 140 gms



**MD-11-01-0673**

Mallet 26 cm / 10 1/4"  
30 mm  $\varnothing$  / 510 gms



27mm  $\varnothing$  / 320 gms

**MD-11-01-0674**

Mead Mallet 19 cm / 7 1/2"  
With interchangeable plastic disks



**MD-11-01-0675**

Partsch Mallet 19 cm / 7 1/2"  
With hollow handle 22mm  $\varnothing$  / 200 gms

ORTHOPEDIC MALLETS – S/S & FIBRE



**MD-11-01-0676**

Mallet 26 cm / 10 ¼" with lead filling  
42mm ø / 400 gms



**MD-11-01-0677**

Mallet 26 cm / 10 ¼" without lead filling  
42mm ø / 400 gms

- A: 26mm ø / 300 gms
- B: 28mm ø / 340 gms
- C: 30mm ø / 400 gms



**MD-11-01-0678**

Williger Mallet 24 cm / 9 ½" lead filled  
42mm ø / 400 gms



**MD-11-01-0679**

Mallet 30 mm ø / 675 gms  
26.5 cm / 10 ½" plane (Teflon) / convex (steel)



**MD-11-01-0680**

Mallet 26 cm / 10 ¼"  
42 / 30mm ø / 530 gms



**MD-11-01-0681**

Mallet 24 cm / 9 ½"  
30 mm ø / 480 gms



**MD-11-01-0682**

Mallet 24 cm / 9 ½"  
Disks and handle of Fiber 37 mm ø / 370 gms



**MD-11-01-0683**

Mallet 22 cm / 8 ¾"  
30 mm ø / 125 gms



**MD-11-01-0684**

Mallet 26.5 cm / 10 ½" | 30 mm ø / 450 gms

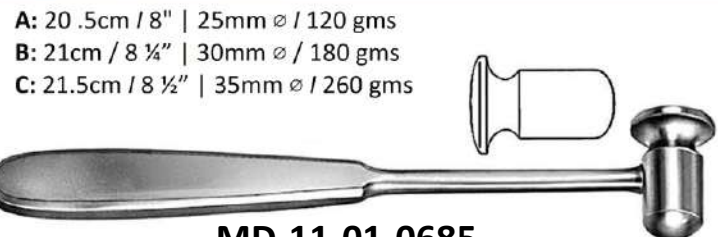

**MD-11-01-0685**

Doyen Mallet

- A: 20 .5cm / 8" | 25mm ø / 120 gms
- B: 21cm / 8 ¼" | 30mm ø / 180 gms
- C: 21.5cm / 8 ½" | 35mm ø / 260 gms

ELEVATORS SPINAL – S/S & FIBRE



**MD-11-01-0686**

Herbert Mallet 19 cm / 7 ½"  
For ulnar head prosthesis



**MD-11-01-0687**

Collin Mallet 20 cm / 8"  
23 mm ø / 220 gms



**MD-11-01-0688**

Mallet 26.5 cm / 10 ½"  
50 mm ø / 900 gms



*Teflon disks*

**MD-11-01-0689**

Vickers Mallet 19 cm / 7 ½"  
25 mm ø / 300 gms



**MD-11-01-0690**

Kirk Mallet 20cm / 8"  
Head Dia 38mm / Weight: 1 lb. 4 oz. (570 grams)

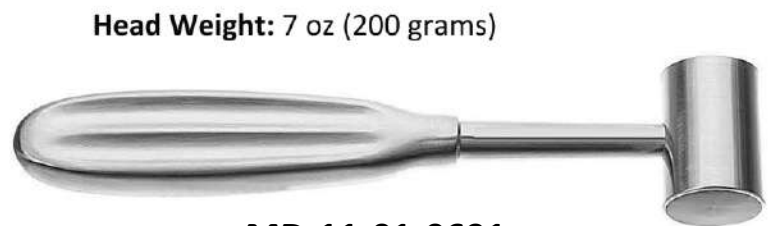

**Head Weight: 7 oz (200 grams)**

**MD-11-01-0691**

Gerzog Mallet 19 cm / 7 ½"  
Head Dia 25mm / Weight 10 oz (285 grams)



**Head Weight: 20 oz (567 grams)**

**MD-11-01-0692**

Heath Mallet 19 cm / 7 ½"  
Head Dia 40mm / Weight 2 lbs. (907gm)



**Head Weight: 20 oz (567 grams)**

**MD-11-01-0693**

Heath Mallet, SS 18 cm / 7" Solid Frame Handle  
Head Dia 40mm / Weight 36 oz. (1020gm)

## ELEVATORS SPINAL – S/S & FIBRE



**MD-11-01-0694**

All Fibre Mallet 24 cm / 9 ½"  
Head Dia 80X60mm Weight 14oz. (397gm)



Fibre Handle

**MD-11-01-0695**

Cloward Mallet 19cm / 7 ½"  
Head Dia 20mm / Weight 8oz. (227gm)



**MD-11-01-0696**

Hajek Mallet 20 cm / 8"  
Head Dia 27mm / Weight: 7 oz. (198gm)



Fibre Handle

**MD-11-01-0697**

Narrow Tip Mallet 20cm / 8"  
Head Dia 7mm Weight 6oz. (170gm)

**B:** Head Dia 35mm Weight 11b 40 oz. (570gm)  
**C:** Head Dia 40mm Weight 11b 90 oz. (708gm)



**MD-11-01-0698**

Fibre Handle Mallet 23cm / 9"  
**A:** Head Dia 30mm / Weight 12 oz. (340gm)



**MD-11-01-0699**

He-Man Mallet 28cm / 11"  
Head Dia 38mm / 24mm / Weight 21b (906gm)



**MD-11-01-0704**

Bunnell Tendon Stripper 15 cm / 6"



**MD-11-01-0705**

Fischer Tendon Stripper 31 cm / 12 1/4" Blunt



**MD-11-01-0706**

Tendon Passing Instrument 33.5 cm / 13 1/4"



**MD-11-01-0707**

Fischer Tendon Stripper 31 cm / 12 1/4" Blunt



**MD-11-01-0708**

Tendon Stripper 3 / 4 / 5 / 6mm  
A: 28.5 cm / 11 1/4" B: 60 cm / 24"



**MD-11-01-0709**

Bunnell Tendon Passer 23 cm / 9" Malleable



**MD-11-01-0710**

Downing Cartilage Knife 25 cm / 10"  
Concave Edge Cvd Blade w/ Guards



**MD-11-01-0711**

Lowe Breck Cartilage Knife 25cm/10" STR Edge-Cvd Blade w / Guards



**MD-11-01-0712**

Tendon Stripper 40 cm / 16" Fibre Handle

## TENDON INSTRUMENTS



**MD-11-01-0719-1**  
Carroll Tendon Holding Forceps  
11.5 cm / 4 1/2"

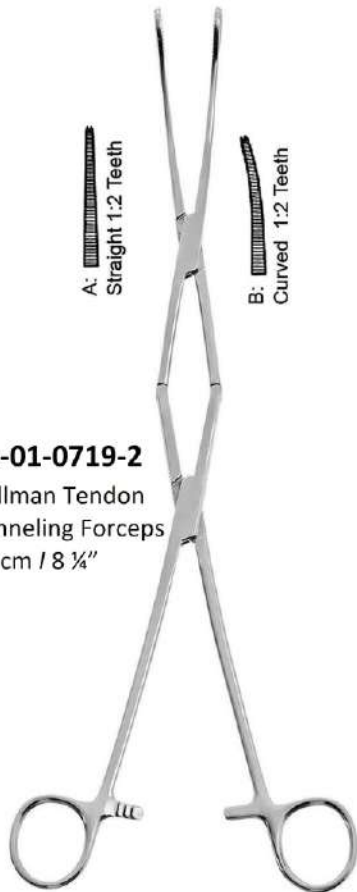

**11-01-0719-2**  
Hallman Tendon  
Tunneling Forceps  
21 cm / 8 1/4"

A: Straight 1:2 Teeth

B: Curved 1:2 Teeth

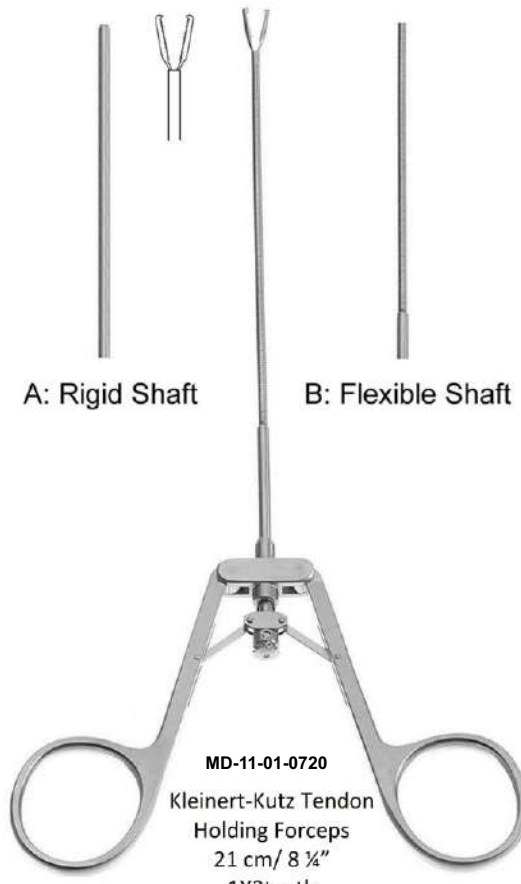

**MD-11-01-0720**  
Kleinert-Kutz Tendon  
Holding Forceps  
21 cm / 8 1/4"  
1X2teeth

A: Rigid Shaft

B: Flexible Shaft



**11-01-0721**  
Hoen Grasping Forceps  
14 cm / 5 1/2" (Shaft)  
1X2 teeth

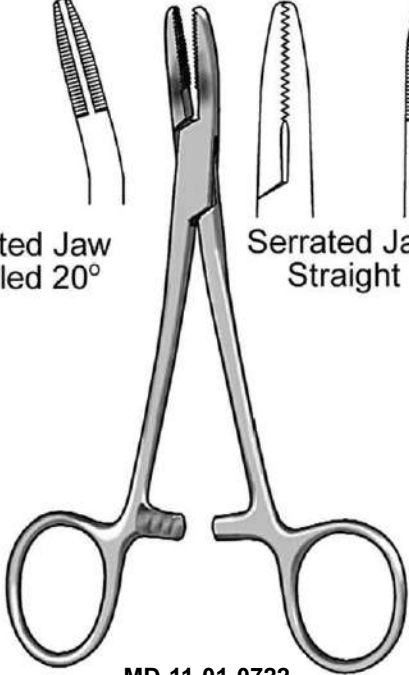
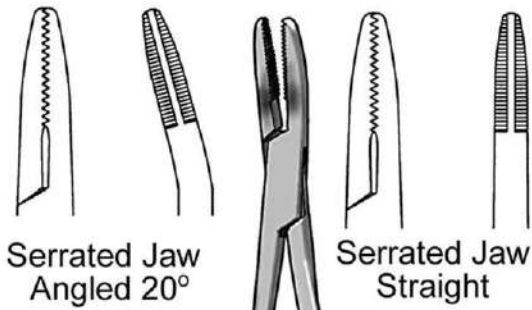

**MD-11-01-0722**  
Meniscus Clamp  
13.5 cm / 5 3/8" 1X2 teeth

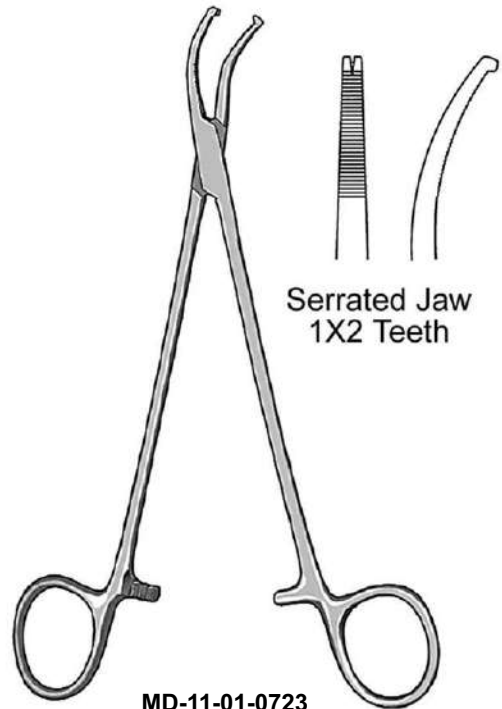

**MD-11-01-0723**  
Preston Ligamentum Flavum Forceps  
(Meniscus) 18.5 cm / 7 1/4"



**Straight**

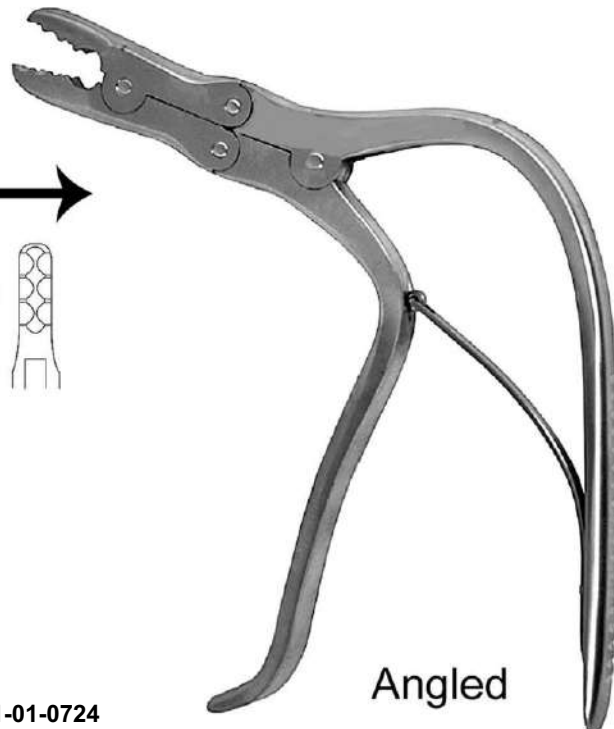
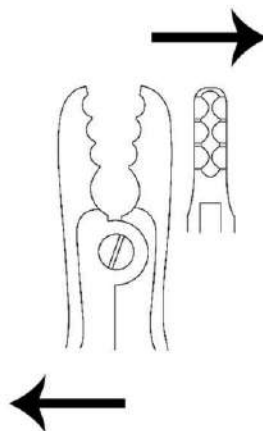

**Angled**

**MD-11-01-0724**  
Ortho Grasper 21 cm / 8 1/2"  
7 X 20 MM Bite

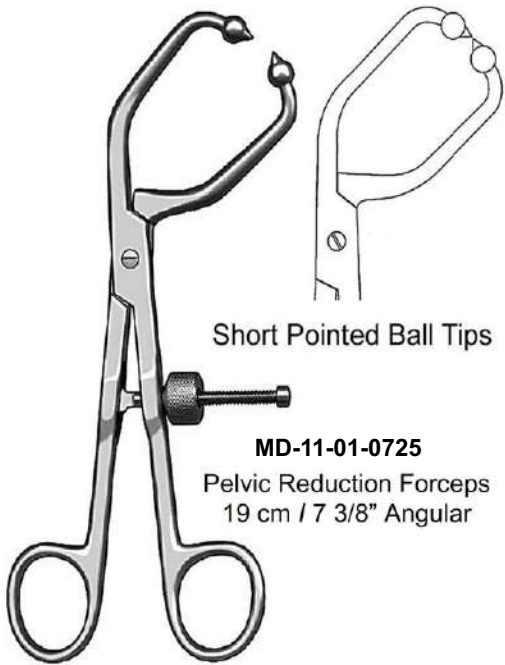

Short Pointed Ball Tips

**MD-11-01-0725**  
Pelvic Reduction Forceps  
19 cm / 7 3/8" Angular

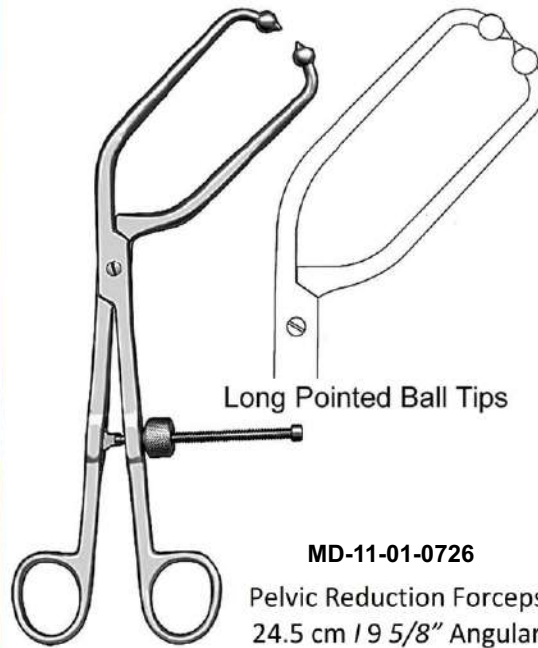

Long Pointed Ball Tips

**MD-11-01-0726**  
Pelvic Reduction Forceps  
24.5 cm / 9 5/8" Angular

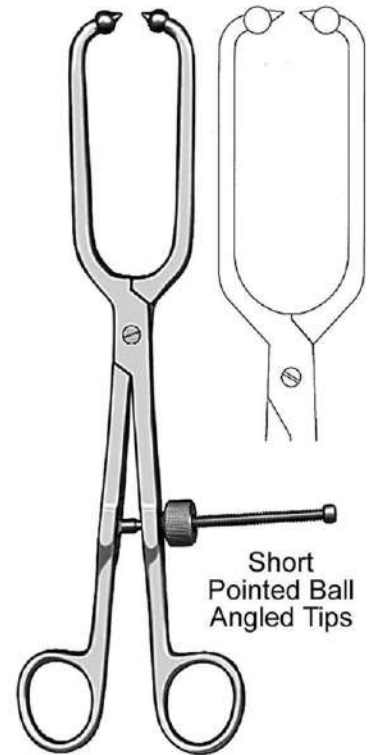

Short Pointed Ball Angled Tips

**MD-11-01-0727**  
Pelvic Reduction Forceps  
25 cm / 10"



Long Pointed Ball Tips

**MD-11-01-0728**  
Pelvic Reduction Forceps  
Available in 2 Sizes  
A: 24 cm / 9 1/2"  
B: 41cm / 16"

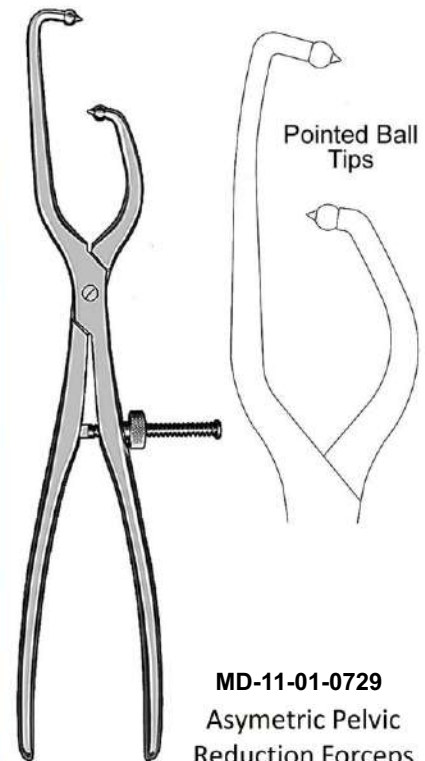

Pointed Ball Tips

**MD-11-01-0729**  
Asymmetric Pelvic  
Reduction Forceps  
41 cm / 16"



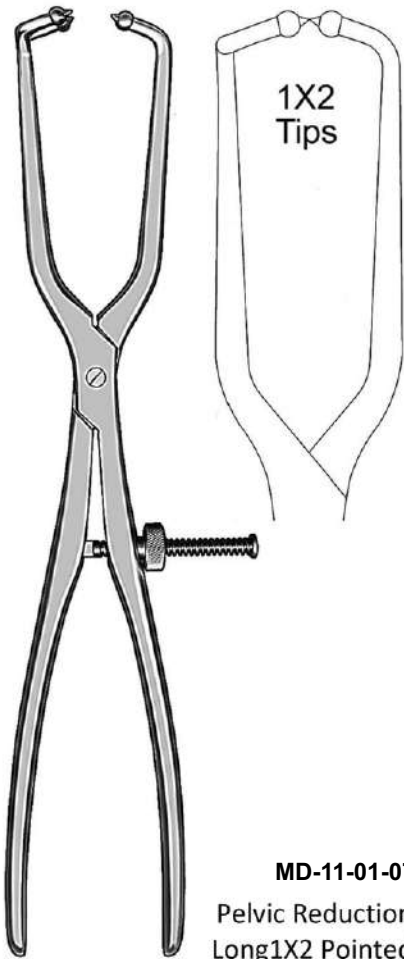

**MD-11-01-0730**  
Pelvic Reduction Forceps  
Long 1X2 Pointed Ball Tips  
41 cm / 16"

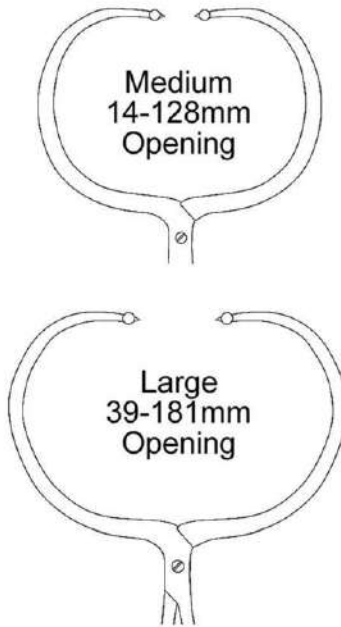

**MD-11-01-0731**  
Periarticular Reduction Forceps  
Straight / Pointed Ball Tips  
38 cm / 15"



**MD-11-01-0732**  
Pelvic Reduction Forceps  
Adjustable Jaws for Screws  
A: 25 cm / 10" B: 33 cm / 13"



BONE HOLDING FORCEPS

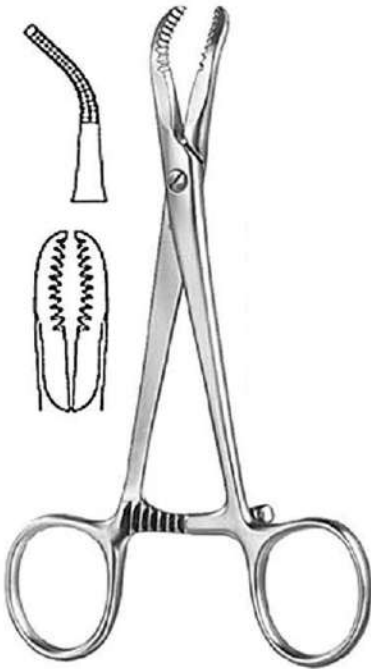

**MD-11-01-0733**

Bone Holding Forceps  
14 cm / 5 1/2"

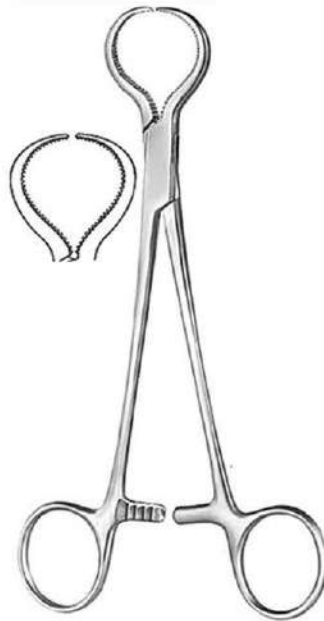

**MD-11-01-0734**

Lewin Bone Holding Forceps  
18.5 cm / 7 1/4"



**MD-11-01-0735**

Bone Holding Forceps  
14 cm / 5 1/2" Delicate



**MD-11-01-0736**

Frosch Bone Holding Forceps 18 cm / 7"



**MD-11-01-0737**

Bone Holding Forceps 20 cm / 8"



**MD-11-01-0738**

Semb Bone Holding Forceps 19 cm / 7 1/2"



**MD-11-01-0739**

Lengenbeck Bone Holding Forceps 21 cm / 8 1/4"



**MD-11-01-0740**

Fergusson Bone Holding Forceps Heavy pattern  
21 cm / 8 1/4"



**11-01-0741** A: 23 cm / 9" B: 26 cm / 10 1/4"

Farabeuf Bone Holding Forceps

BONE HOLDING FORCEPS



**MD-11-01-0742**  
Kern Bone Holding Forceps  
**A:** 17 cm / 6 ¾"  
**B:** 21 cm / 8 ¼"

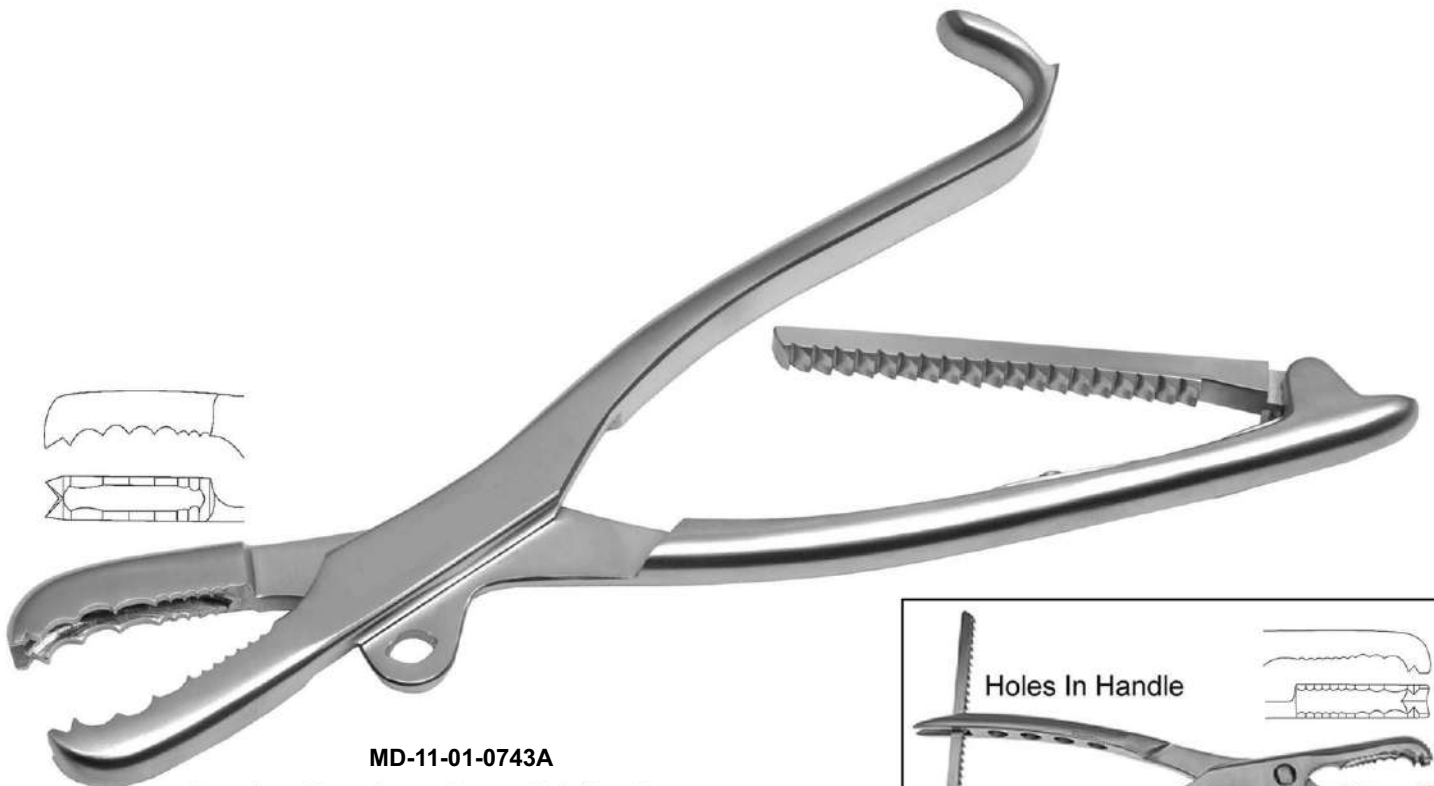

**MD-11-01-0743A**  
Farabeuf Lambotte Bone Holding Forceps  
**A:** 23 cm / 9" | **B:** 26 cm / 10"  
Adjustable / with Ratchet



**MD-11-01-0743B**

## BONE HOLDING FORCEPS

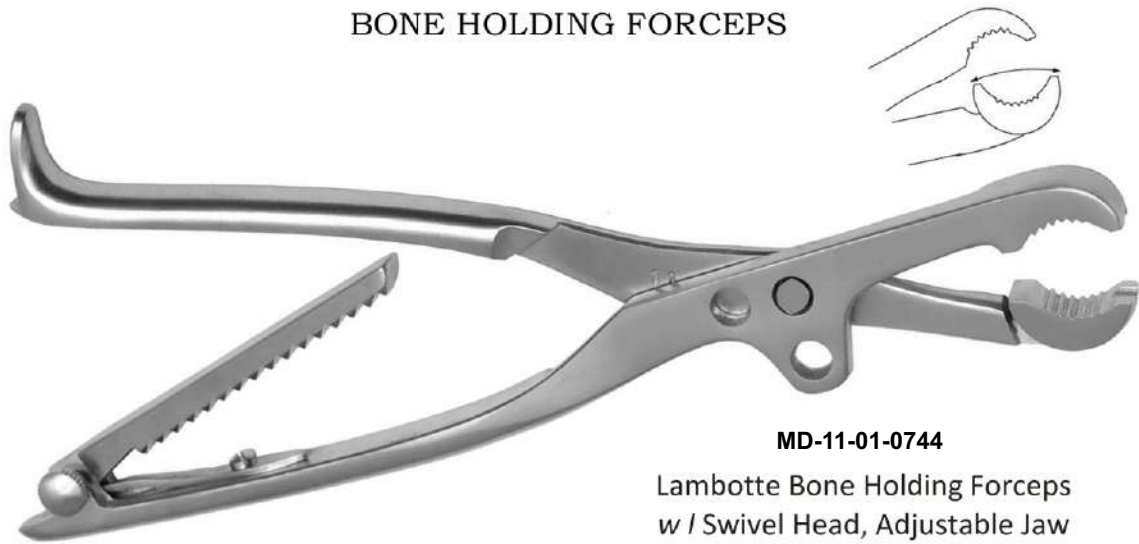

**MD-11-01-0744**

Lambotte Bone Holding Forceps  
w / Swivel Head, Adjustable Jaw

**A: 22 cm | 8 ¾" | B: 27 cm | 10 ¾" | C: 30 cm | 11 ¾"**



**MD-11-01-0745**

Ulrich Bone Holding Forceps  
w / Thread Fixation 19 cm / 7 ¼"

**MD-11-01-0746**  
Ulrich Bone Holding Forceps  
w / Thread Fixation  
**A: 23 cm / 9" | B: 25 cm / 9 ¾" | C: 28 cm / 11"**

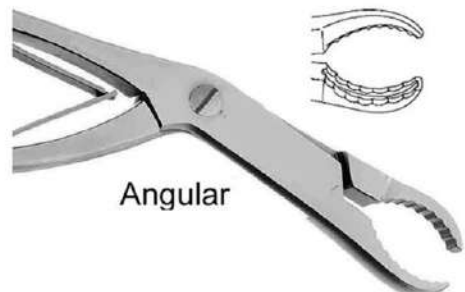

Angular

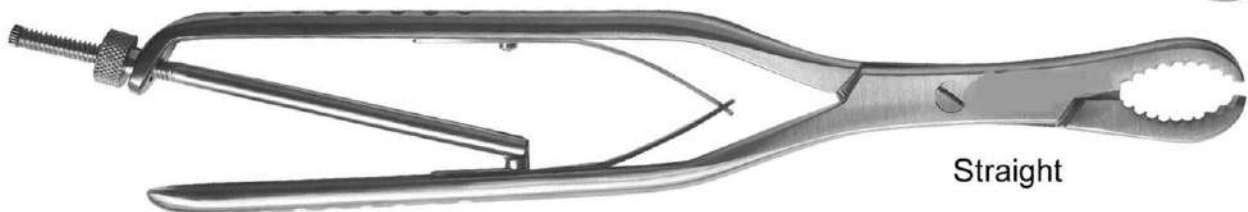

Straight

## BONE HOLDING FORCEPS

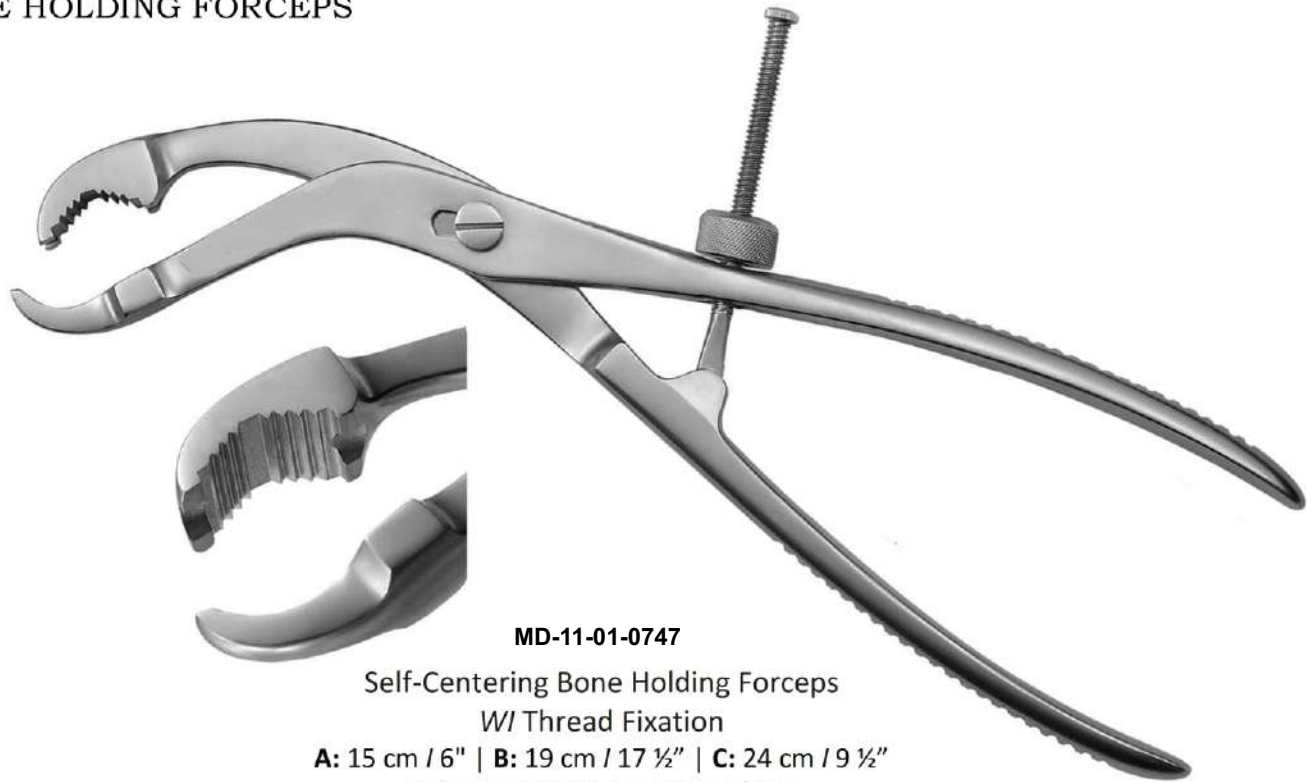

**MD-11-01-0747**

Self-Centering Bone Holding Forceps  
W/ Thread Fixation

**A:** 15 cm / 6" | **B:** 19 cm / 17 ½" | **C:** 24 cm / 9 ½"  
**D:** 26 cm / 10 ¼" | **E:** 28 cm / 11"



**MD-11-01-0748**

Lane Bone Holding Forceps w / Ratchet

**A:** 33 cm / 13"  
**B:** 45 cm / 17 ¾"

**MD-11-01-0749**

Without Ratchet

## BONE HOLDING FORCEPS



**MD-11-01-0750**

Hey Groves Bone Holding Forceps

A: 20 cm / 8" | B: 25 cm / 10" | C: 30 cm / 12"



**MD-11-01-0751**

Verbrugge Bone Holding Forceps

A: 17.5 cm / 7" | B: 25 cm / 9 ¾"  
C: 26 cm / 10 ¼" | D: 27 cm / 10 ¾"



**MD-11-01-0752**

Smooth Jaws Bone Holding Forceps

23 cm / 9"

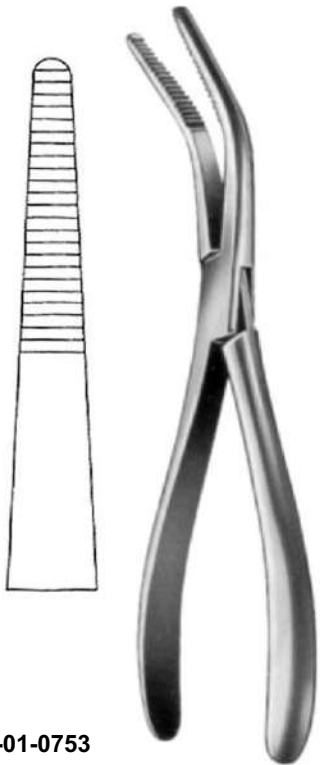

**MD-11-01-0753**  
Van Buren Bone Holding Forceps  
21.5 cm / 8 1/2"

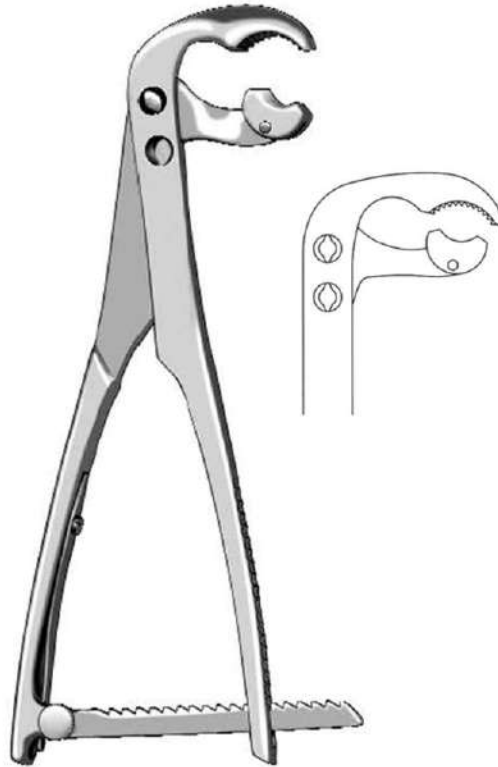

**MD-11-01-0754**  
Angled Bone Holding Forceps 23 cm / 9"

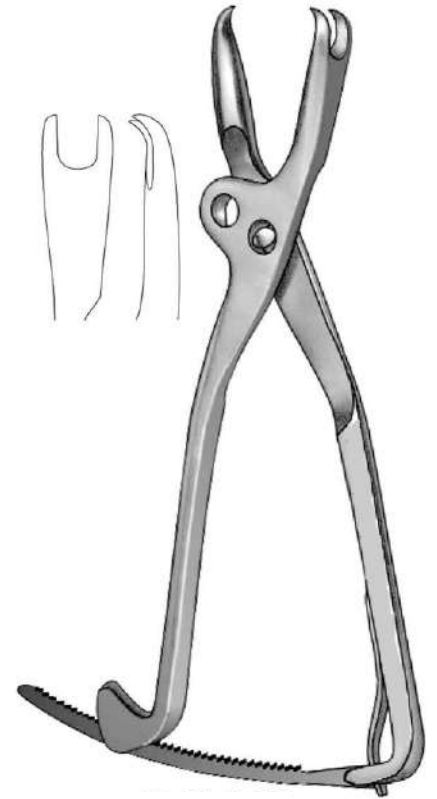

**MD-11-01-0755**  
Bishop Bone Holding Forceps 23 cm / 9"



**MD-11-01-0756**  
Bone Holding Forceps  
A: 17cm 6 3/4" 0.9mm  
B: 13cm 5 1/4" 1.6mm

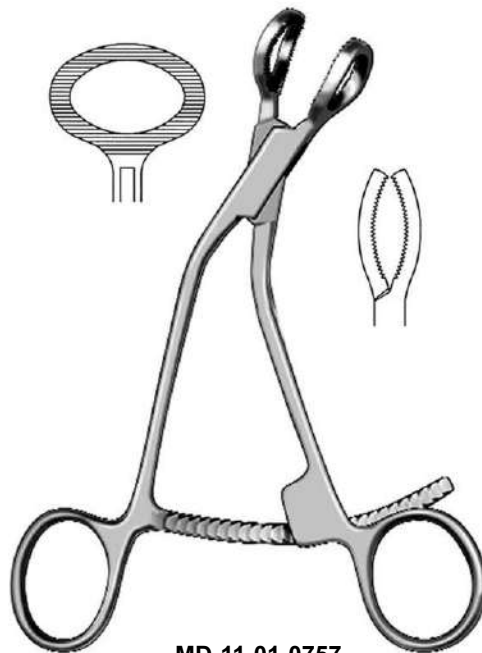

**MD-11-01-0757**  
Bishop Bone Holding Forceps  
23 cm / 9"

1X2 Prong



2X2 Prong

**MD-11-01-0758**  
Patella Forceps 18 cm / 7"

BONE HOLDING FORCEPS



MD-11-01-0759

Hayton Williams Forward Traction Forceps  
Broad Tips 23 cm / 9"



MD-11-01-0760

Fibula Bone Holding Forceps  
21 cm / 8 1/2"



MD-11-01-0762A

Semb Bone Holding Forceps  
Curved Sideward  
21 cm / 8 1/2"



MD-11-01-0761

Bone Holding Forceps  
w/ Thread Fixation  
15 cm / 6"





Small

Large

**MD-11-01-0762B**

Bargo Bone Holding Forceps 15 cm / 6"

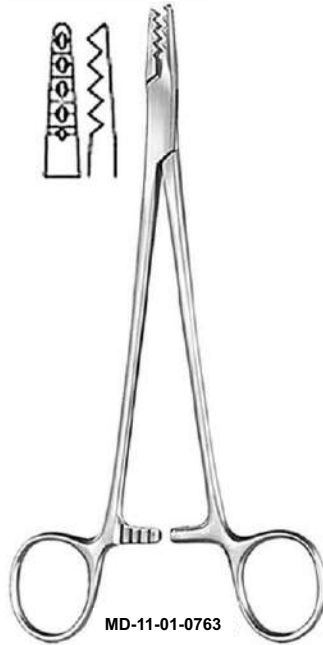

**MD-11-01-0763**

Martin Cartilage Seizing Forceps  
18.5 cm / 7 1/4"

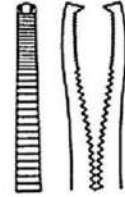
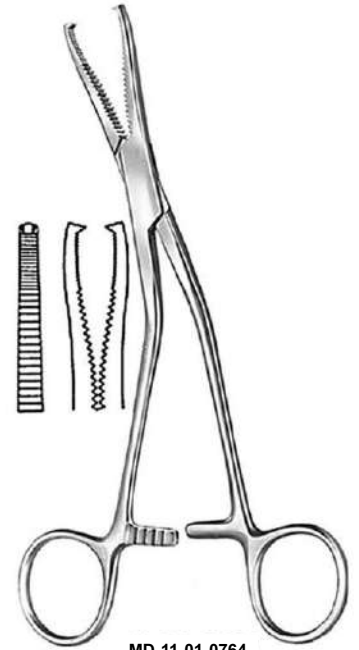

**MD-11-01-0764**

Dingmann Cartilage Seizing Forceps  
18.5 cm / 7 1/4"



**MD-11-01-0765**

Reposition Forceps  
13.5 cm / 5 1/4" Long ratchet pointed



**MD-11-01-0766**

Reposition Forceps  
15 cm / 6" Long Ratchet Pointed

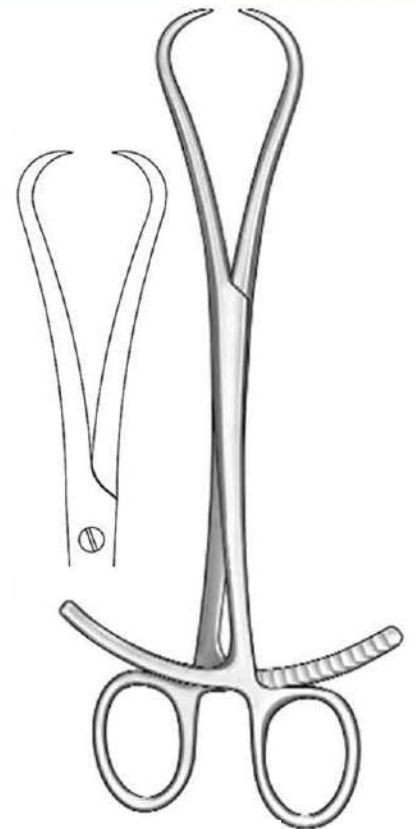

**MD-11-01-0767**

Walton Bone Reduction Forceps  
20.5 cm / 8" | 2" Double Ratchet  
Opening 9-100mm

## REPOSITION – CARTILAGE FORCEPS

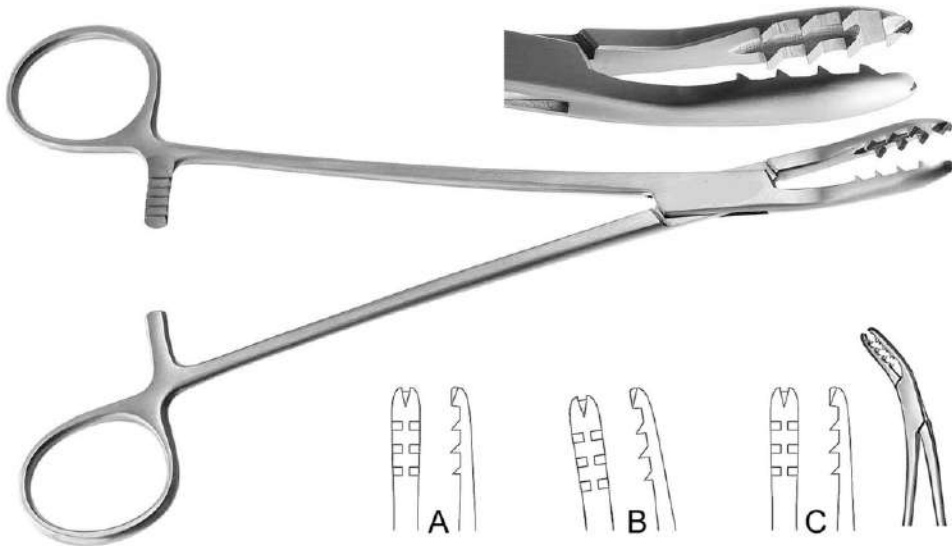

**MD-11-01-0768**

Cartilage Seizing Forceps

A: Straight | B: Upward Cvd | C: Sideward Cvd

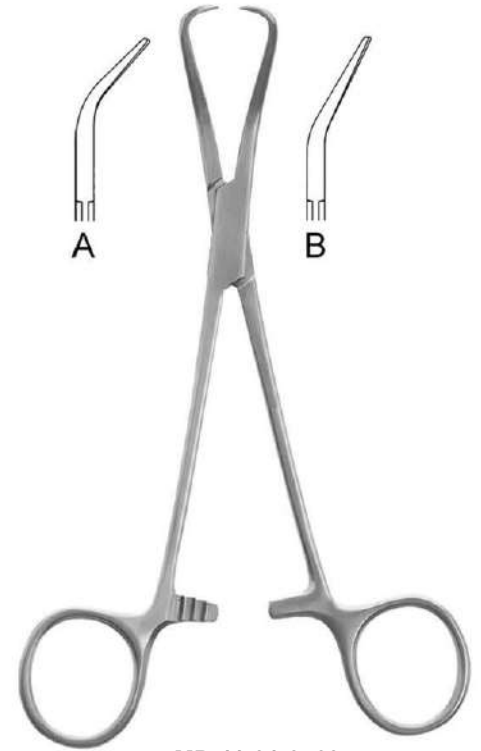

**MD-11-01-0769**

Glenoid Perforating Forceps 17cm / 6 1/2"

A: Strong Cvd | B: Slight Cvd



**MD-11-01-0770**

Bone Reposition Forceps  
w / Thread Fixations Screw

A: 17 cm / 6 3/4"

B: 24 cm / 9 1/2"



**MD-11-01-0771**

Reill Bone Reduction Forcep

17.5 cm / 7"

## BONE CUTTING FORCEPS

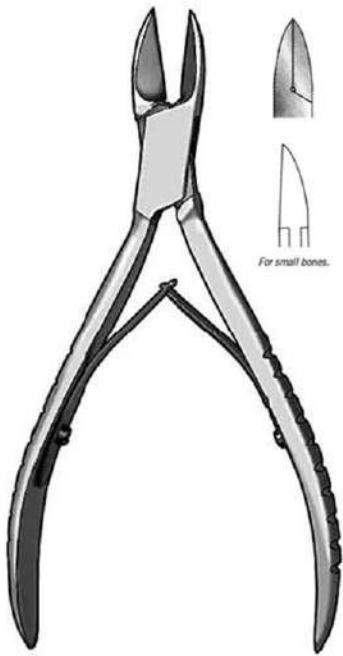

*For small bones.*

**MD-11-01-0772**

Littauer Bone Cutting Forceps  
15 cm / 6"



**MD-11-01-0773**

Marwalder Bone Nipper  
18.5 cm / 7 1/4"



**MD-11-01-0774**

Cottle Kazanjian Bone Cutting  
Forceps 18.5 cm / 7 1/4"

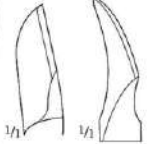
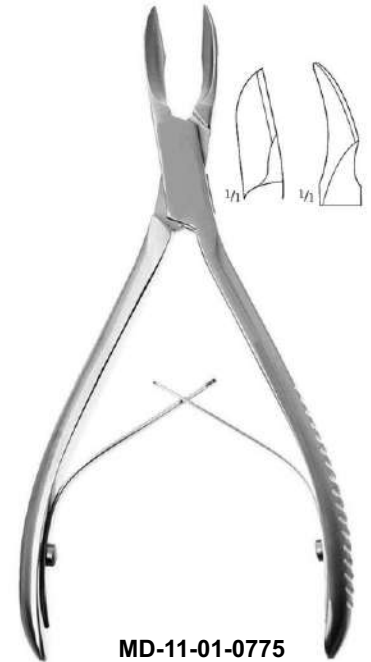

**MD-11-01-0775**

Cleveland Bone Cutting Forceps  
**A:** 14.5 cm / 5 3/4"  
**B:** 17 cm / 6 3/4"

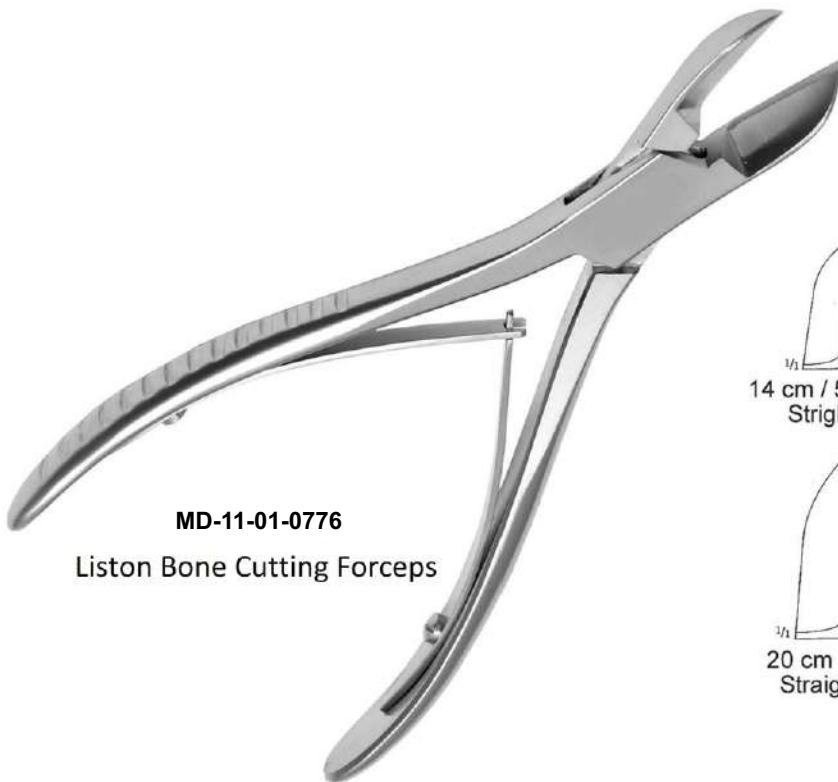

**MD-11-01-0776**

Liston Bone Cutting Forceps

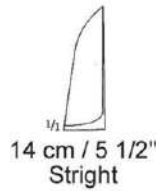

14 cm / 5 1/2"  
Straight



14 cm / 5 1/2"  
Curved

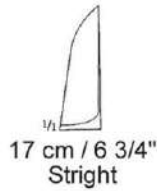

17 cm / 6 3/4"  
Straight



17 cm / 6 3/4"  
Curved



20 cm / 8"  
Straight

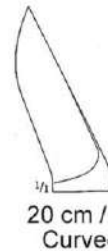

20 cm / 8"  
Curved



22 cm / 8 3/4"  
Straight



22 cm / 8 3/4"  
Curved

## BONE CUTTING FORCEPS

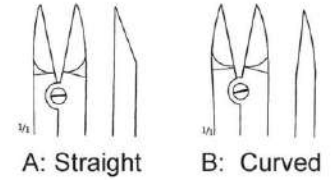

**MD-11-01-0777**

Kleinert-Kutz / Bohler Bone Cutting  
Forceps 14.5 cm / 5 ¾"

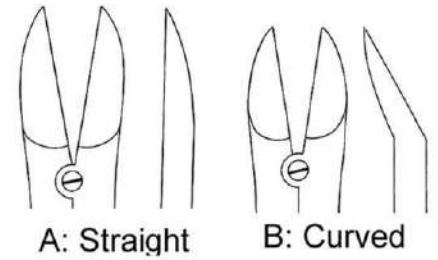

**MD-11-01-0778**

Ruskin Liston Bone Cutting Forceps  
18 cm / 7"

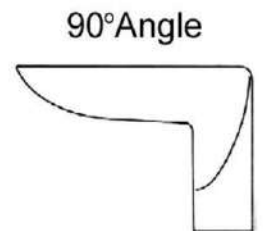

**MD-11-01-0779**

Stille-Liston Bone Cutting Forceps  
26 cm / 10 ¼"



## BONE CUTTING FORCEPS

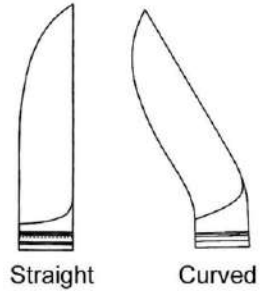

**MD-11-01-0780**

Stille-Liston Bone Cutting Forceps  
A: 23 cm / 9" | B: 27.5 cm / 10 3/4"



**MD-11-01-0781**

Cleveland Bone Cutting Forceps  
16 cm / 6 1/4"

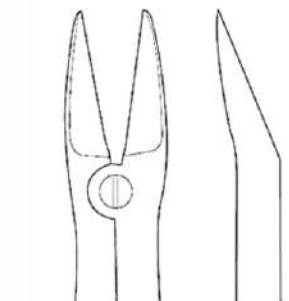

**MD-11-01-0782**

Me Indoe Bone Cutting Forceps  
18 cm / 7" Delicate Blades

BONE CUTTING FORCEPS

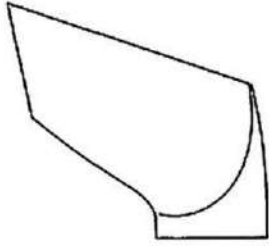

45° Angled

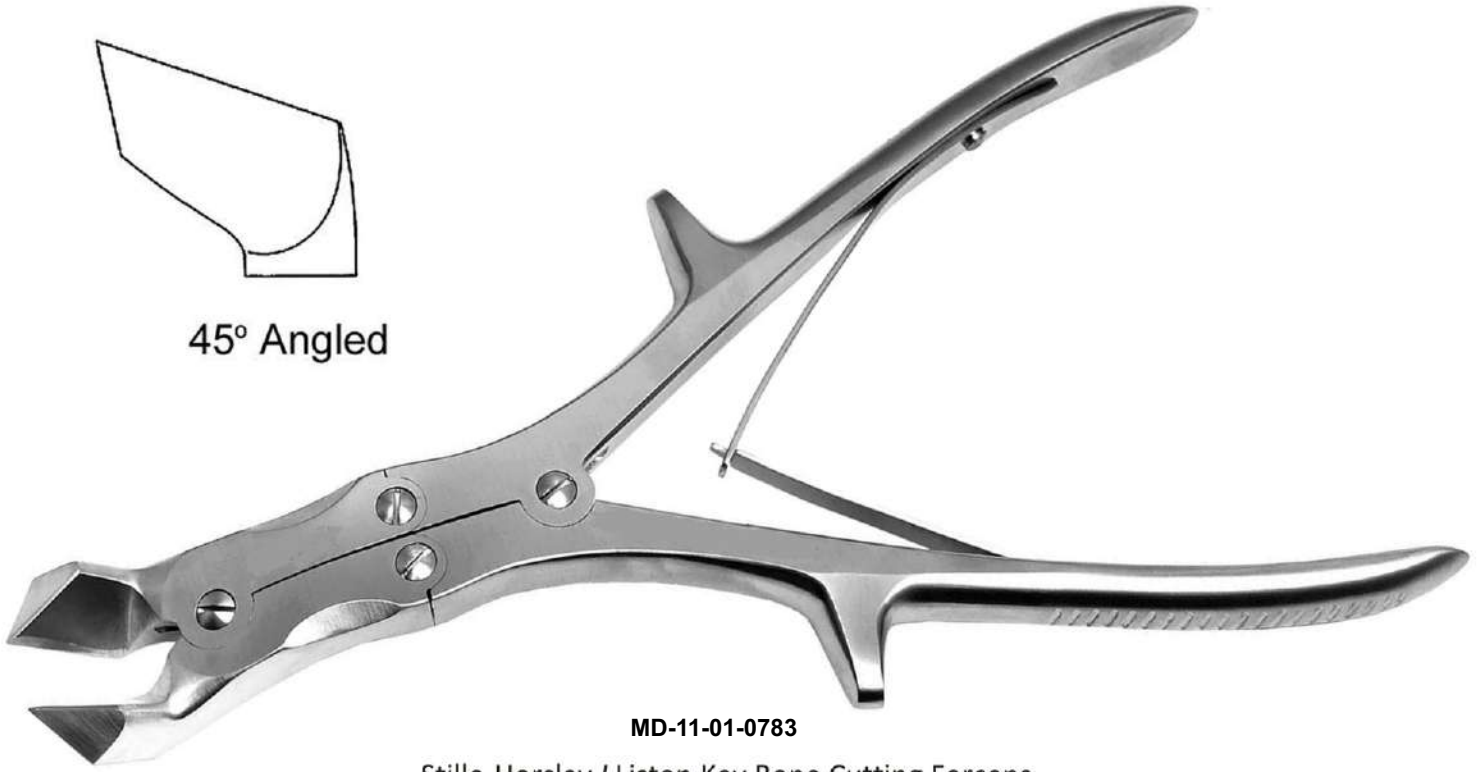

**MD-11-01-0783**

Stille-Horsley / Liston Key Bone Cutting Forceps  
25.5 cm / 10"

90° Angled

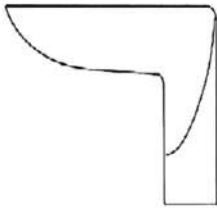

Angled On Side

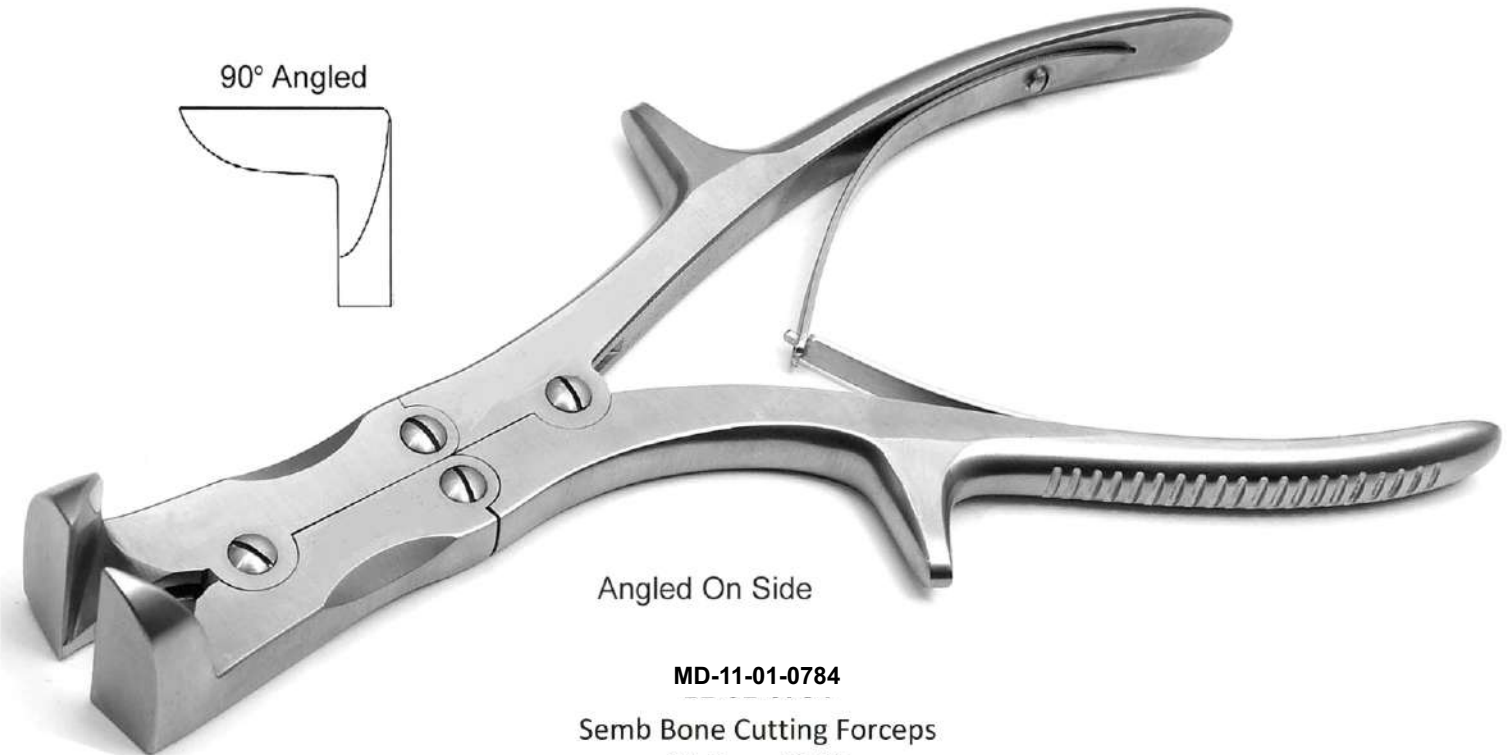

**MD-11-01-0784**

Semb Bone Cutting Forceps  
24.5 cm / 9 3/4"

## BONGE RONGEURS - NIBBLERS

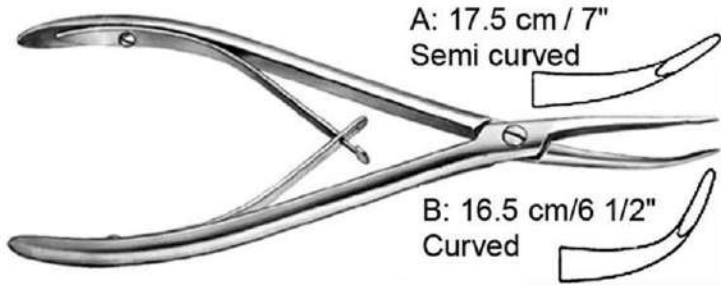

A: 17.5 cm / 7"  
Semi curved

B: 16.5 cm / 6 1/2"  
Curved

**MD-11-01-0785**  
Stellbrink Bone Rongeur

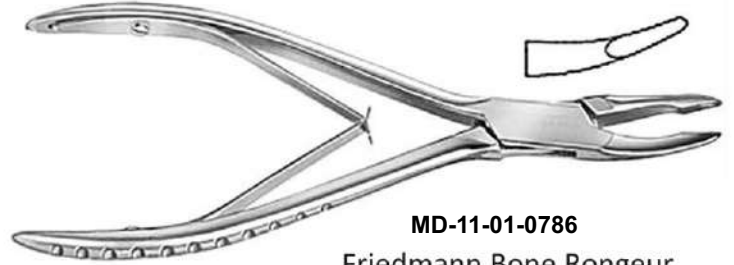

**MD-11-01-0786**

Friedmann Bone Rongeur  
A: 12.5 cm / 5" | B: 13.5 cm / 5 1/4"



**MD-11-01-0787**

Friedmann Bone Rongeur  
13.5 cm / 5 1/4"



**MD-11-01-0788**

Cleveland Bone Rongeur  
A: 13.5 cm / 5 1/4" | B: 16.5 cm / 6 1/2"



**MD-11-01-0789**

Mead Bone Rongeur 16.5 cm / 6 1/2"

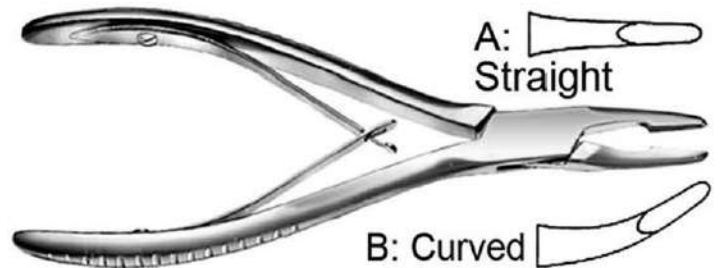

A: Straight

B: Curved

**MD-11-01-0790**

Jansen Bone Rongeur 18 cm / 7"



A

C

B

**MD-11-01-0791-1**

Luer Bone Rongeur 14.5 cm / 5 3/4"

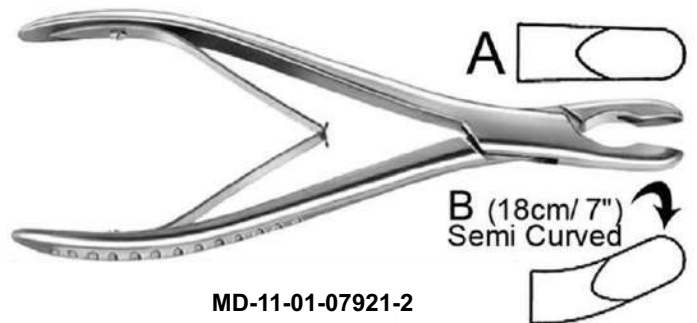

A

B (18cm/7")  
Semi Curved

**MD-11-01-07921-2**

Luer Bone Rongeur 18.5 cm / 7 1/4"

## BONGE RONGEURS - NIBBLERS

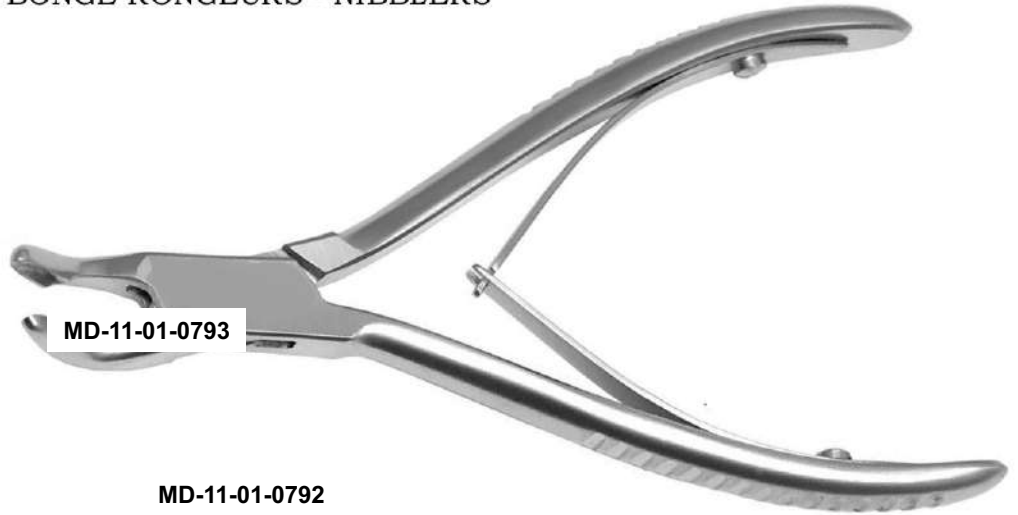
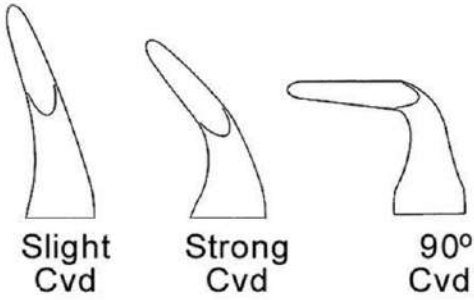

MD-11-01-0792  
Blumental Bone Rongeur 12.5 cm / 5"

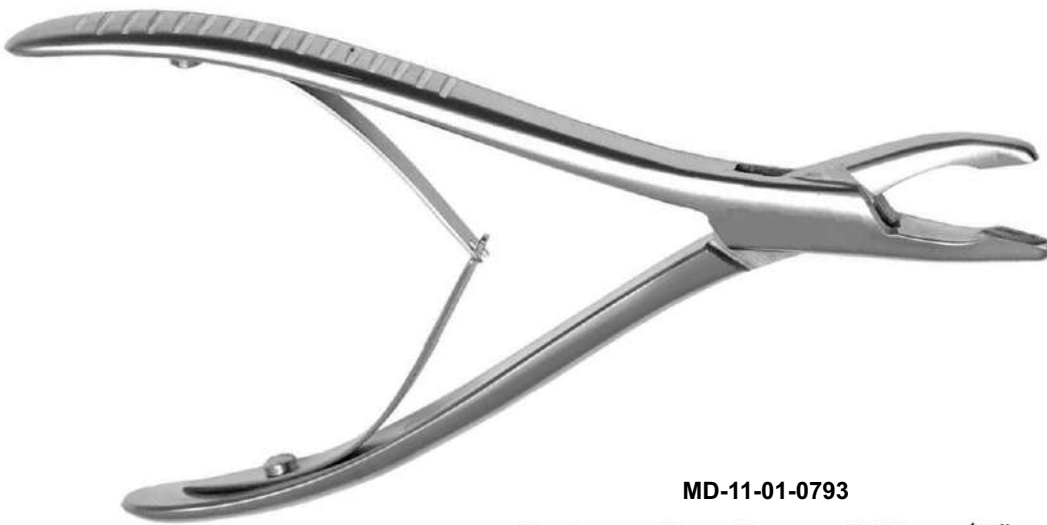

Hartmann Bone Rongeur 17.5 cm / 7"



Jansen Bone Rongeur 19 cm / 7 1/2" Bayonet



## BONGE RONGEURS - NIBBLERS



**MD-11-01-0795**

Jansen Bone Rongeur Straight

A: 14 cm / 5 ½"

B: 17 cm / 6 ½"



**MD-11-01-0796**

Jansen Bone Rongeur Delicate

14 cm / 5 ½"

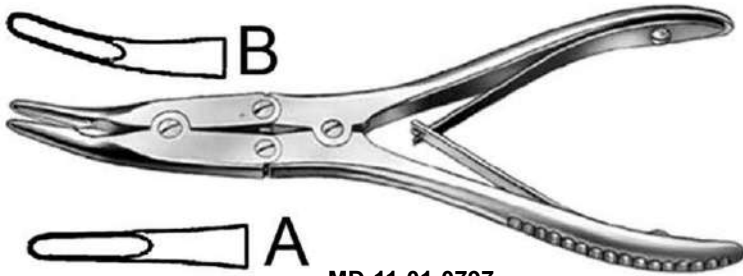

**MD-11-01-0797**

Bohler Bone Rongeur 15.5 cm / 6"



**MD-11-01-0798**

Beyer Bone Rongeur 18 cm / 7"



**MD-11-01-0799**

Zaufai-Jansen Bone Rongeur 18 cm / 7"



**MD-11-01-0800**

Mayfield Bone Rongeur 18 cm / 7"



**MD-11-01-0801**

Marquard Bone Rongeur 20.5 cm / 8"



**MD-11-01-0802**

Lempert Bone Rongeur 19 cm / 7 ½"

## BONGE RONGEURS - NIBBLERS



**MD-11-01-0803**  
Stille Bone Rongeur  
22.5 cm / 8 3/4"

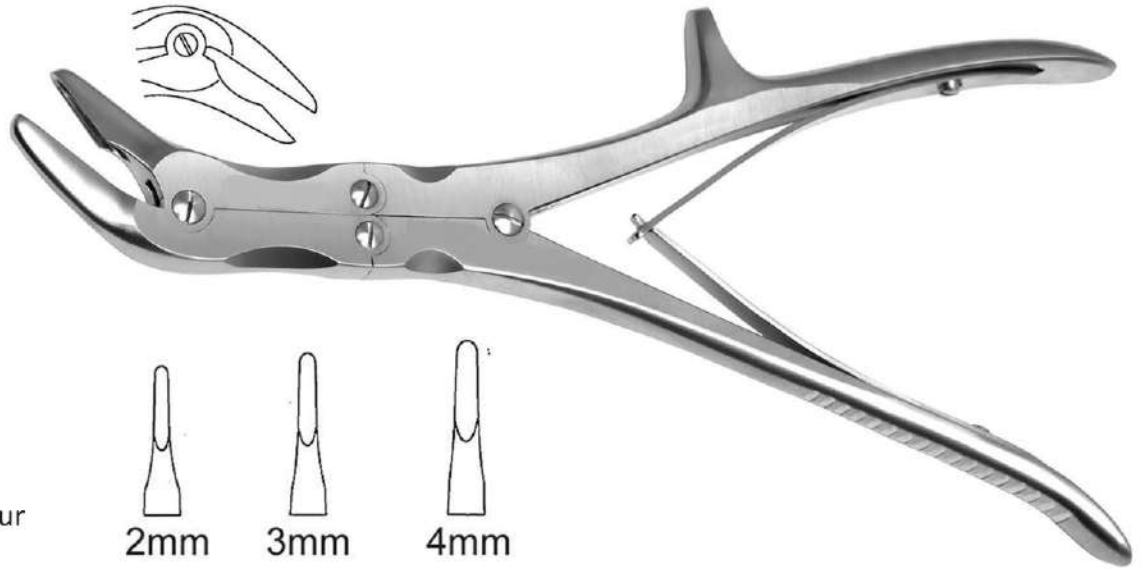

**MD-11-01-0804**  
Echlin Duckbill Bone Rongeur  
22 cm / 8 3/4"

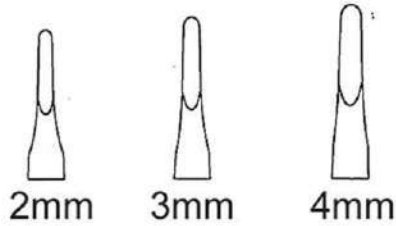

**11-01-0805**  
Ruskin Bone Rongeur  
18 cm / 7"

## BONGE RONGEURS - NIBBLERS



**MD-11-01-0805**  
Ruskin Bone Rongeur  
24 cm / 9 ½"

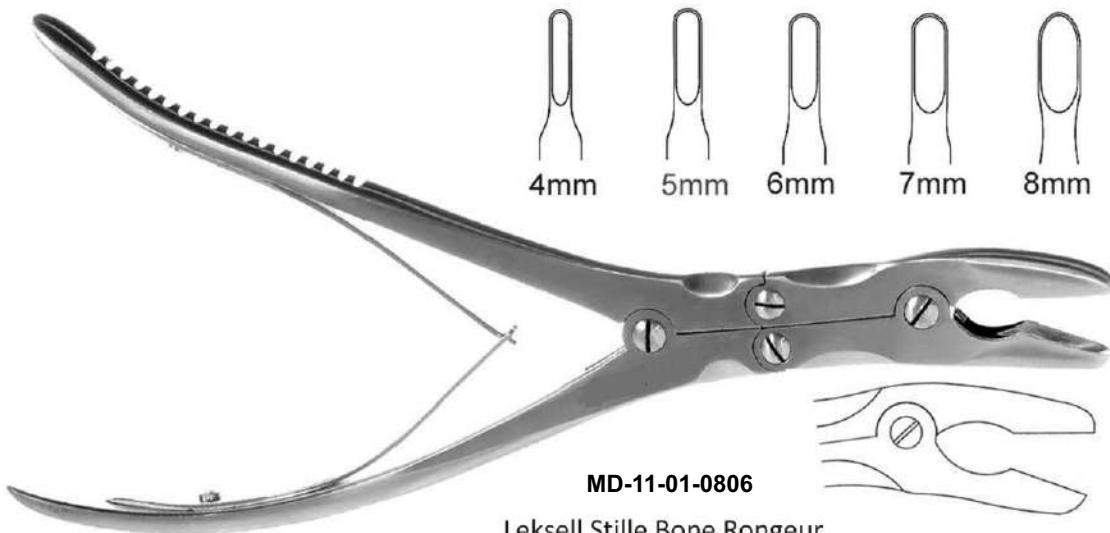

**MD-11-01-0806**  
Leksell Stille Bone Rongeur  
24 cm / 9 ½"

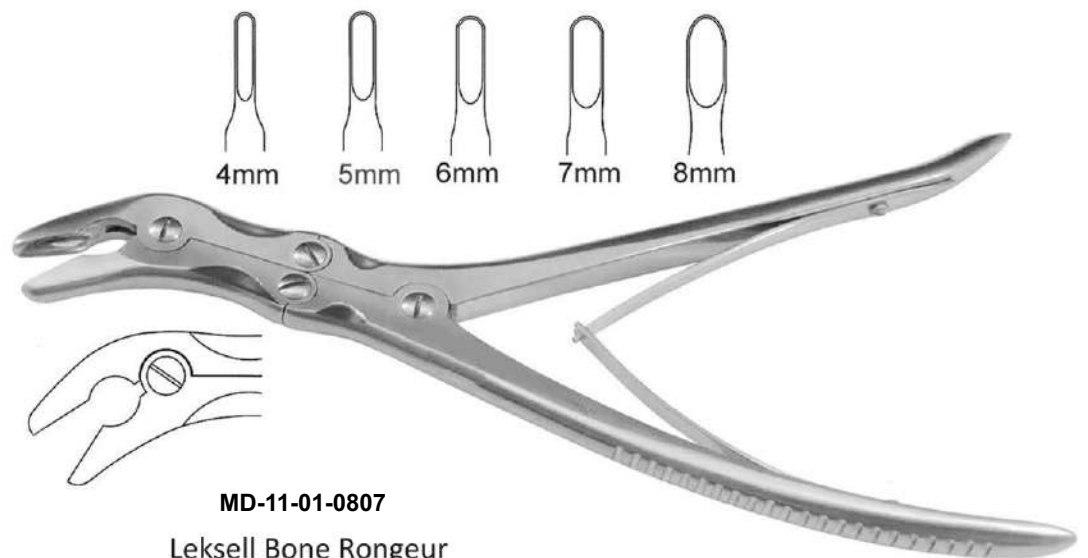

**MD-11-01-0807**  
Leksell Bone Rongeur  
24 cm / 9 ½"

## BONGE RONGEURS - NIBBLERS



**MD-11-01-0808**  
Leksell Bone Rongeur  
23 cm / 9"

- A: Straight
- B: Slight Curved
- C: Strong Curved
- D: Extra Strong Cvd

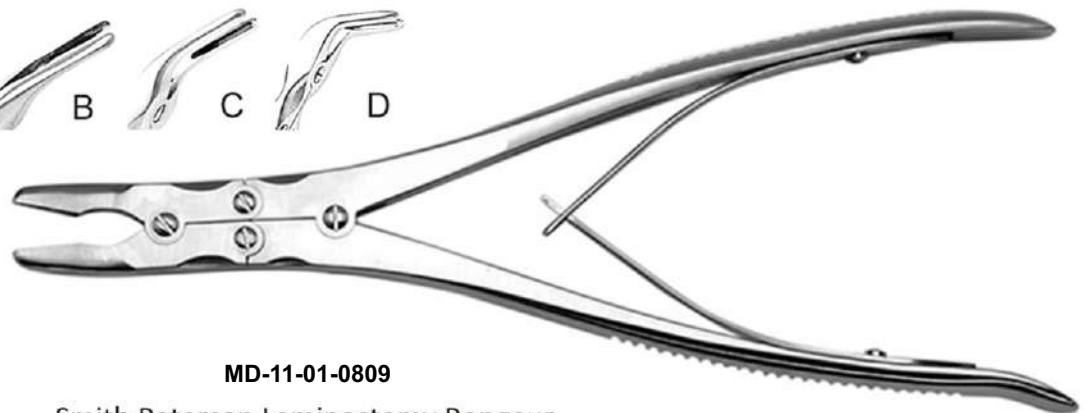

**MD-11-01-0809**  
Smith Peterson Laminectomy Rongeur  
24 cm / 9 ½"

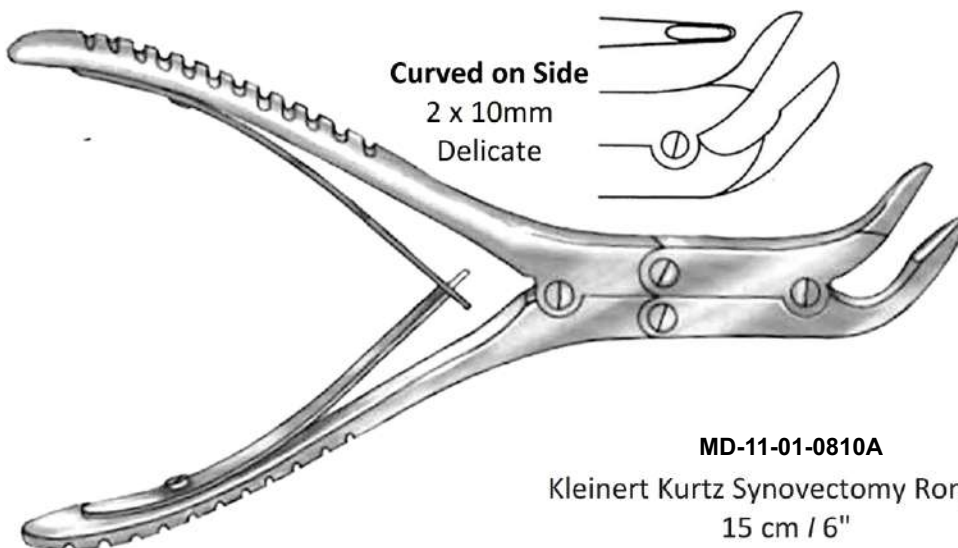

**MD-11-01-0810A**  
Kleinert Kurtz Synovectomy Rongeur  
15 cm / 6"

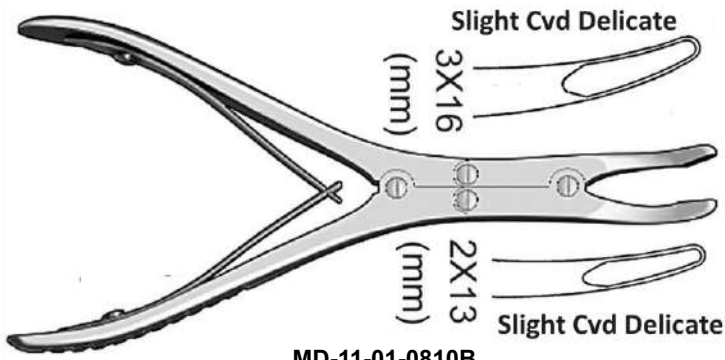

**MD-11-01-0810B**

Kleinert Kurtz Synovectomy Rongeur 15 cm / 6"

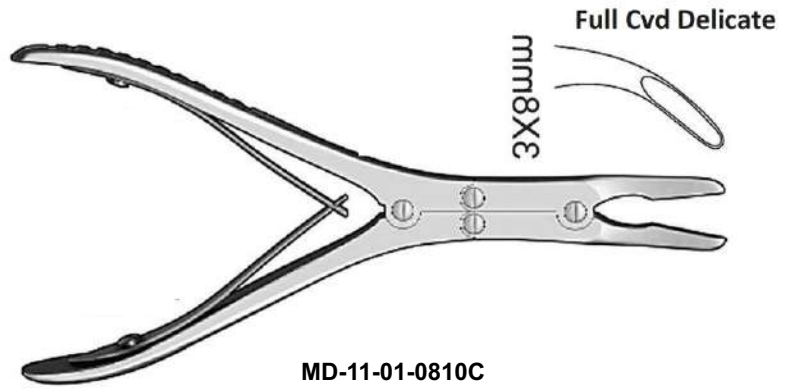

**MD-11-01-0810C**

Kleinert Kurtz Synovectomy Rongeur 15 cm / 6"



**MD-11-01-0811**

Semb Bone Rongeur 23.5 cm / 9 1/4"

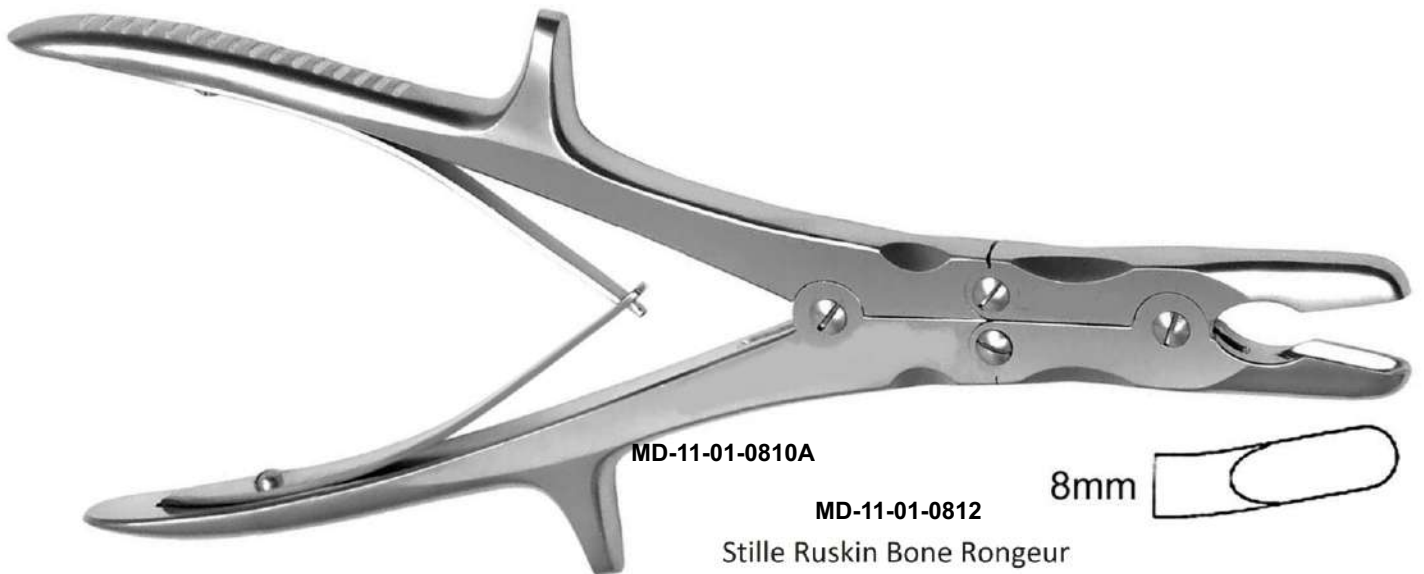

**MD-11-01-0810A**

**MD-11-01-0812**

Stille Ruskin Bone Rongeur  
23.5 cm / 9 1/4"

## BONGE RONGEURS - NIBBLERS

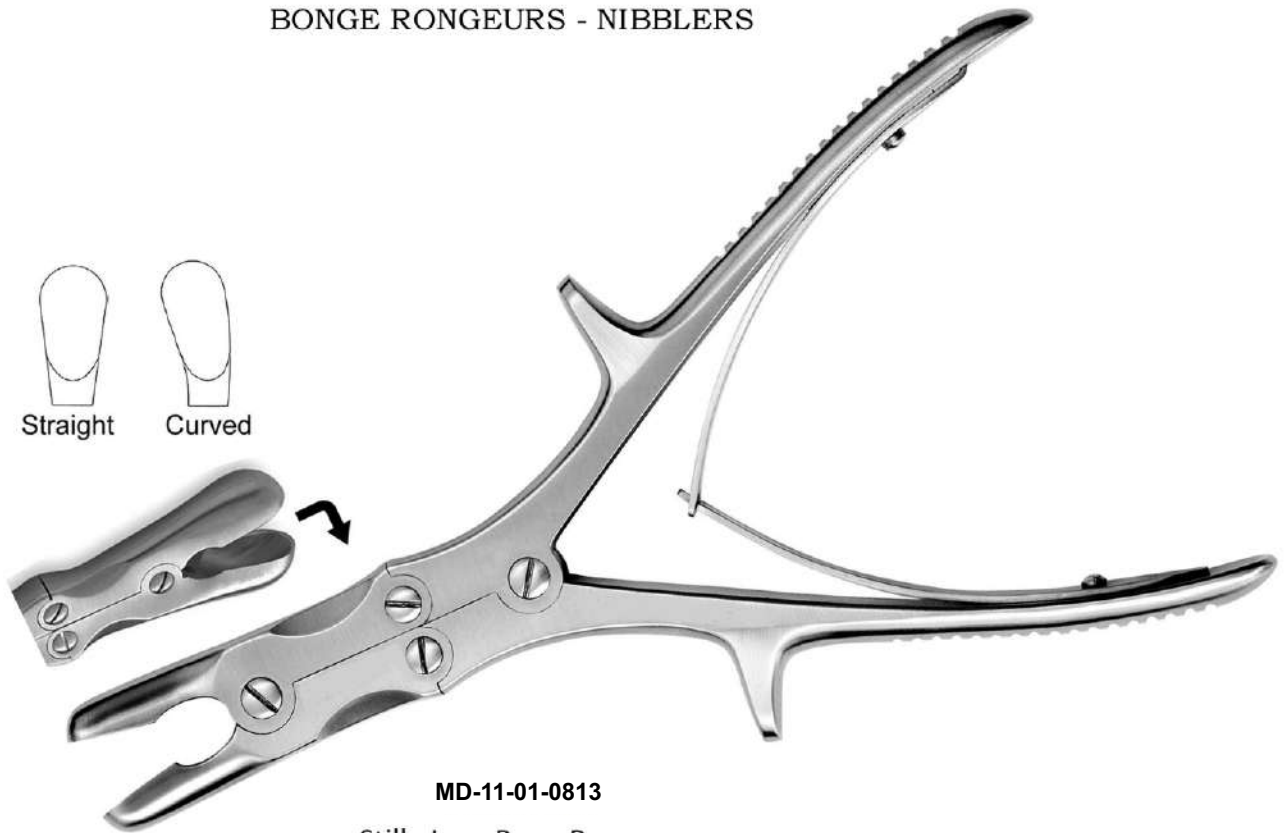

**MD-11-01-0813**

Stille Luer Bone Rongeur  
26.5 cm / 10 ½"

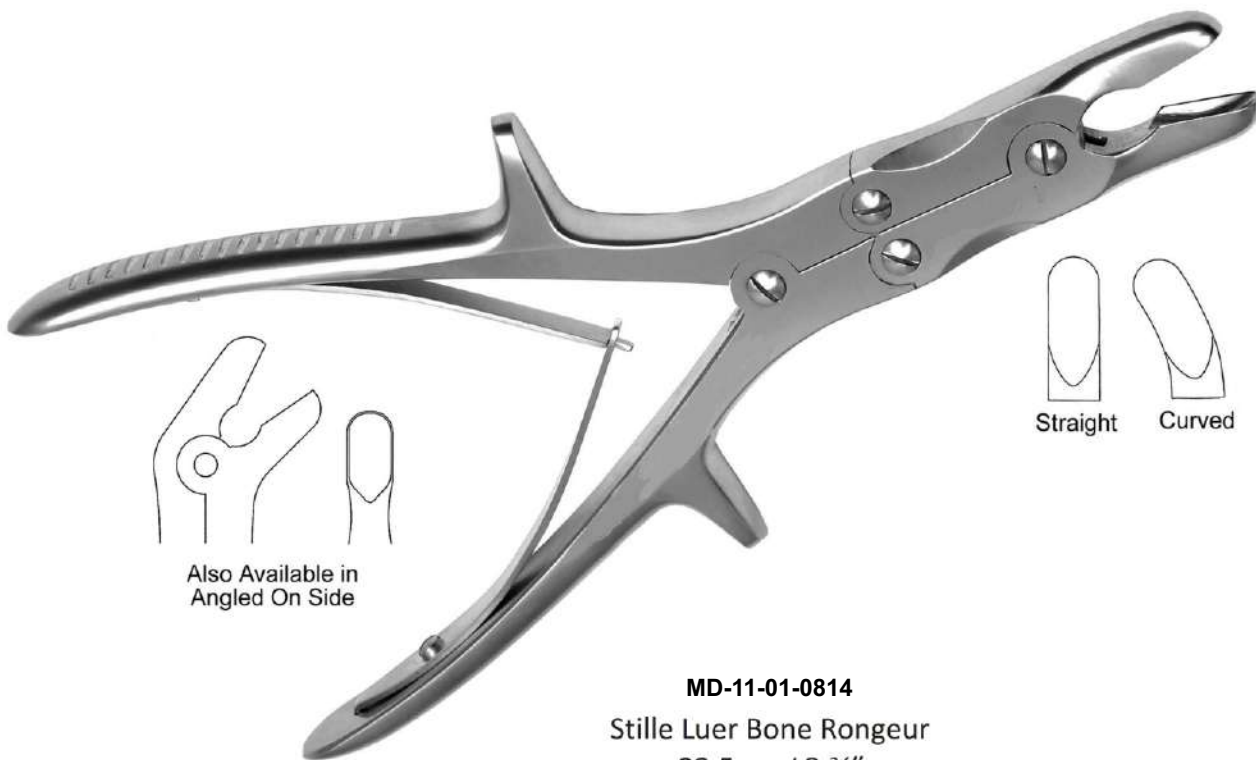

**MD-11-01-0814**

Stille Luer Bone Rongeur  
22.5 cm / 8 ¾"



**MD-11-01-0815**  
Mainz Long Neck Bone Rongeur  
18 cm / 7"



**MD-11-01-0816**  
Leksell Bayonet Rongeur  
41 cm / 16"

A: 3mm  
B: 5mm  
C: 8mm

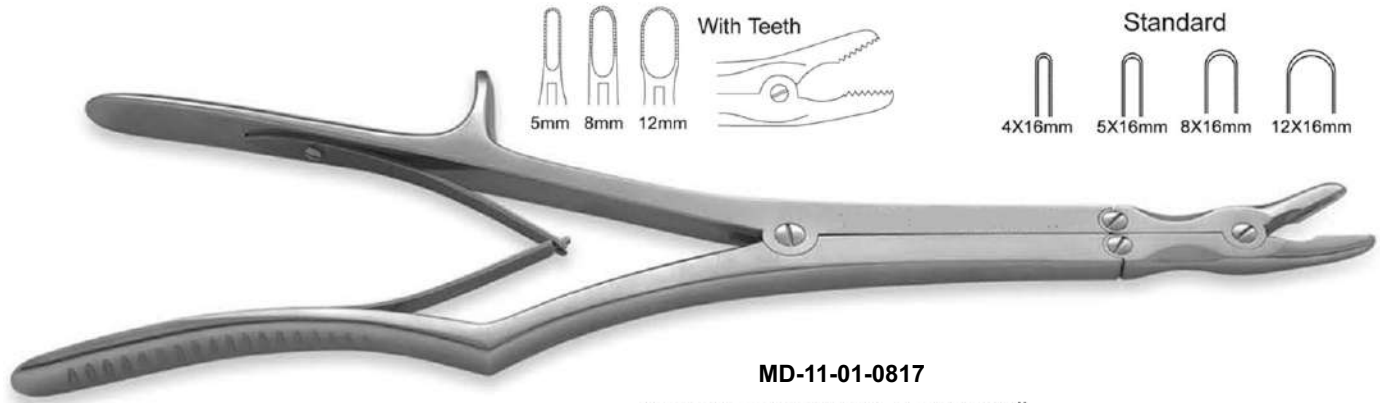

**MD-11-01-0817**  
Syfert Rongeur 37 cm / 14 1/2"

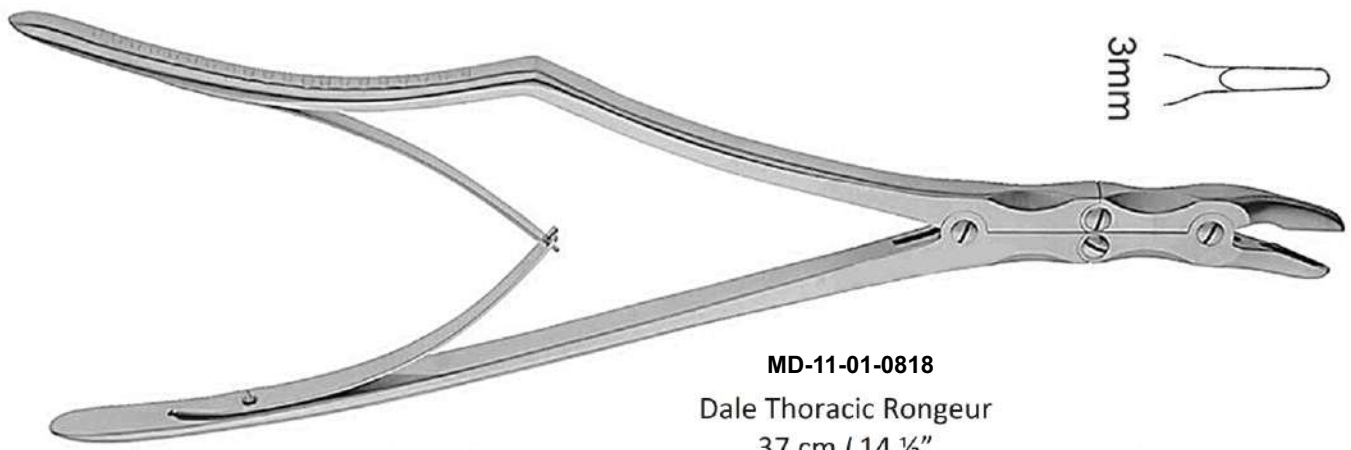

**MD-11-01-0818**  
Dale Thoracic Rongeur  
37 cm / 14 1/2"

## BONGE RONGEURS - NIBBLERS

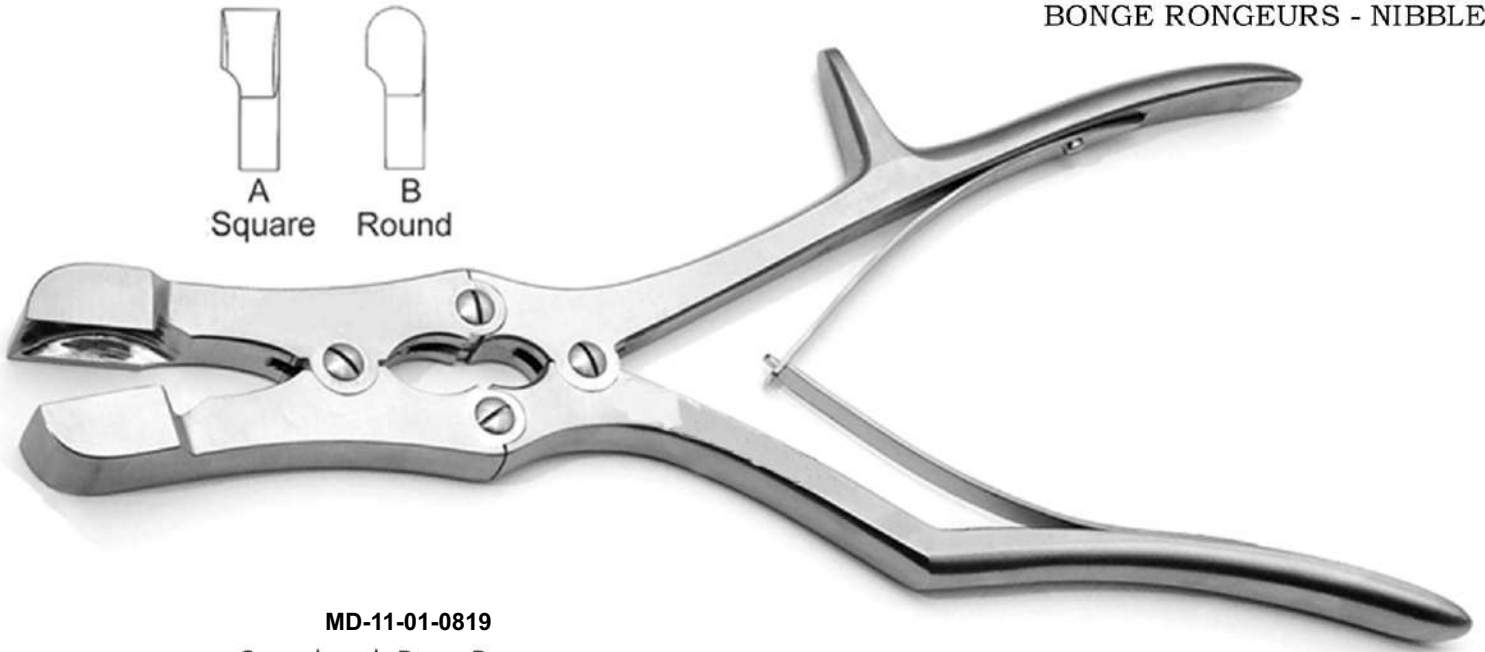

**MD-11-01-0819**  
Sauerbruch Bone Rongeur  
37 cm / 14 ½"

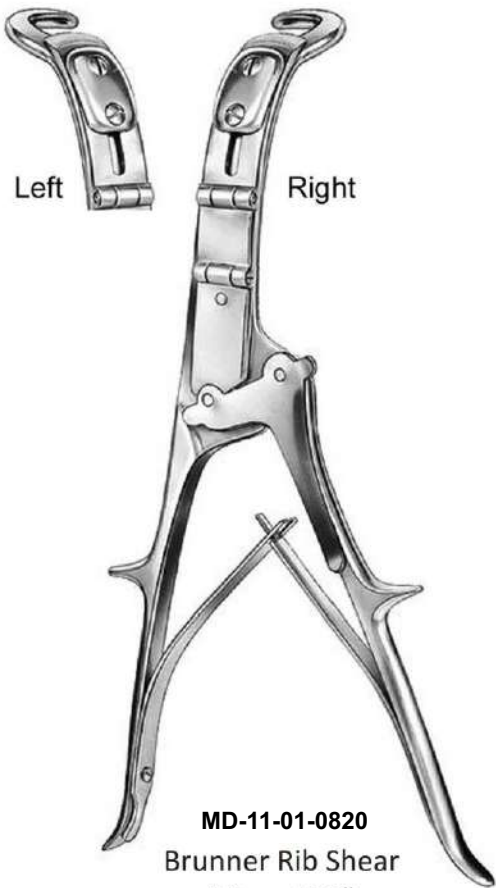

**MD-11-01-0820**  
Brunner Rib Shear  
28 cm / 11"



**MD-11-01-0821**  
Sauerbruch Rib Shear  
A: 23 cm / 9" | B: 26 cm / 10 ¼"





## RIB SHEARS



**MD-11-01-0822**  
Giertz Stille Rib Shear  
25 cm / 10"



**MD-11-01-0823**  
Rib Shear Double Spring 22 cm / 8 3/4"

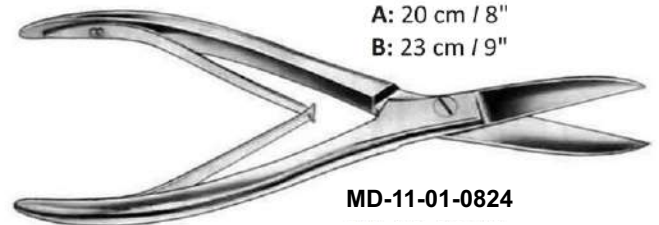

A: 20 cm / 8"  
B: 23 cm / 9"  
**MD-11-01-0824**  
Rib Shear Double Spring



**MD-11-01-0825**  
Collin Rib Shear 17.5 cm / 7"



**MD-11-01-0826**  
Collin Rib Shear 17 cm / 6 3/4"



**MD-11-01-0828**  
Gluck Rib Shear  
A: 16 cm / 6"  
B: 18 cm / 7"  
C: 20 cm / 8"  
D: 23 cm / 9"



**MD-11-01-0827**  
Stille Rib Shear 21 cm / 8 1/4"



## RIB SHEARS

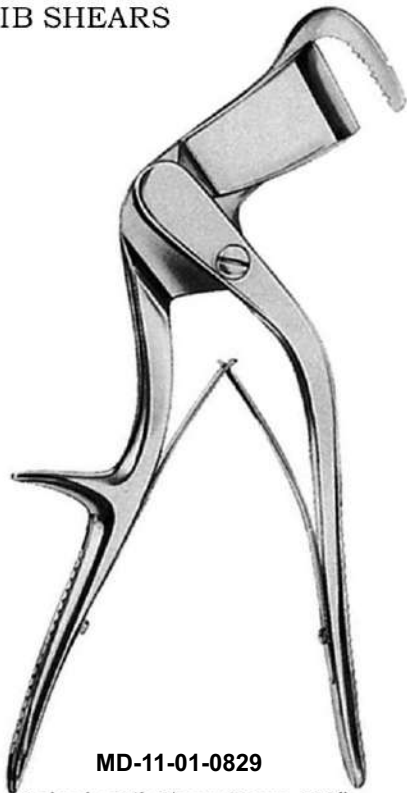

**MD-11-01-0829**  
Labsche Rib Shear 25 cm / 10"

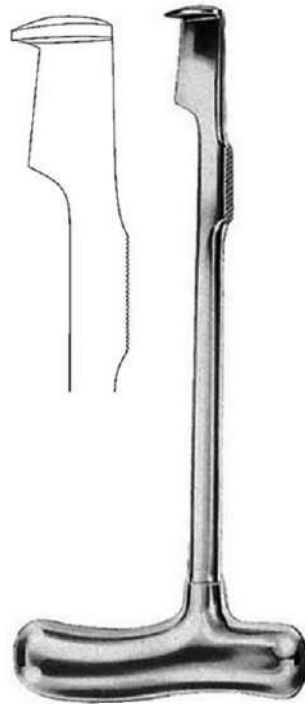

**MD-11-01-0830**  
T Handle Labsehe Sternum Chisel  
24 cm / 9 1/2"



**MD-11-01-0831**  
Rib Shear Sideward 17 cm / 6 3/4"

Pointed  
Tips



**MD-11-01-0832B**  
Bethune Rib Shear  
S Shaped Handle  
34 cm / 13 1/2"



**MD-11-01-0832A**  
Bethune Rib Shear  
S Shaped Handle  
34 cm / 13 1/2"

RIB SHEARS

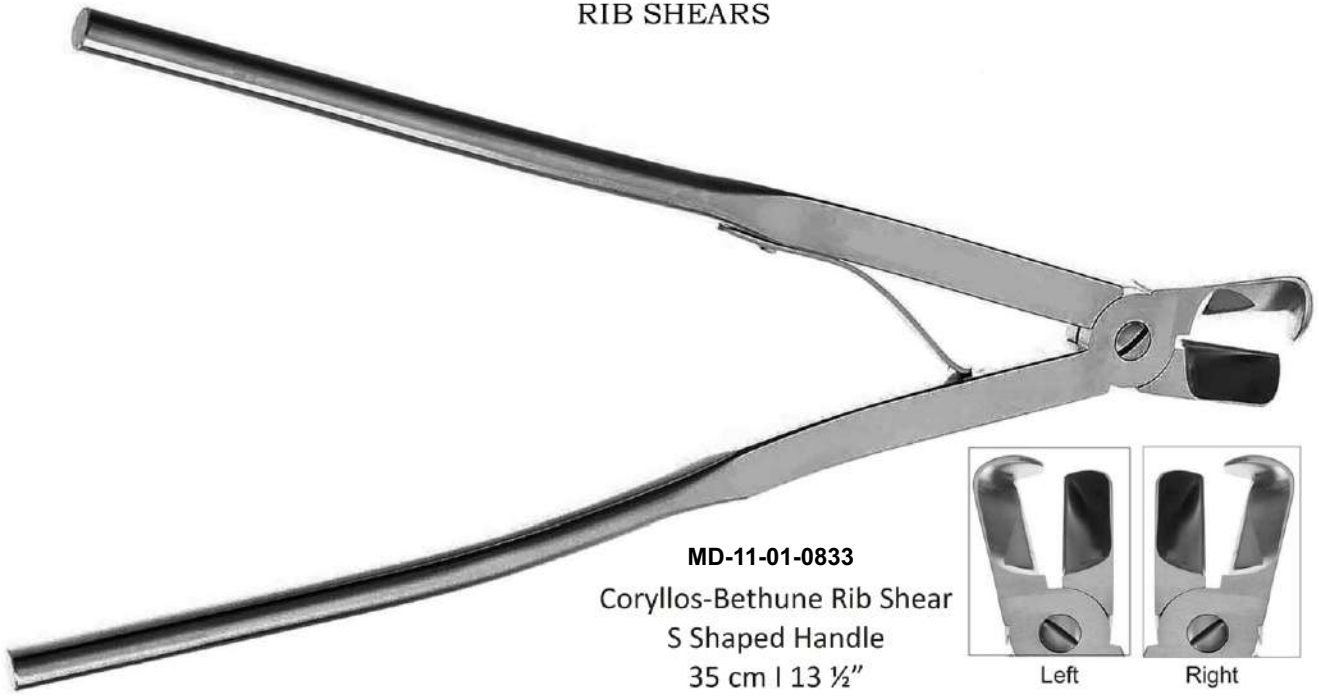



## LAMINA SPREADERS - RETRACTORS

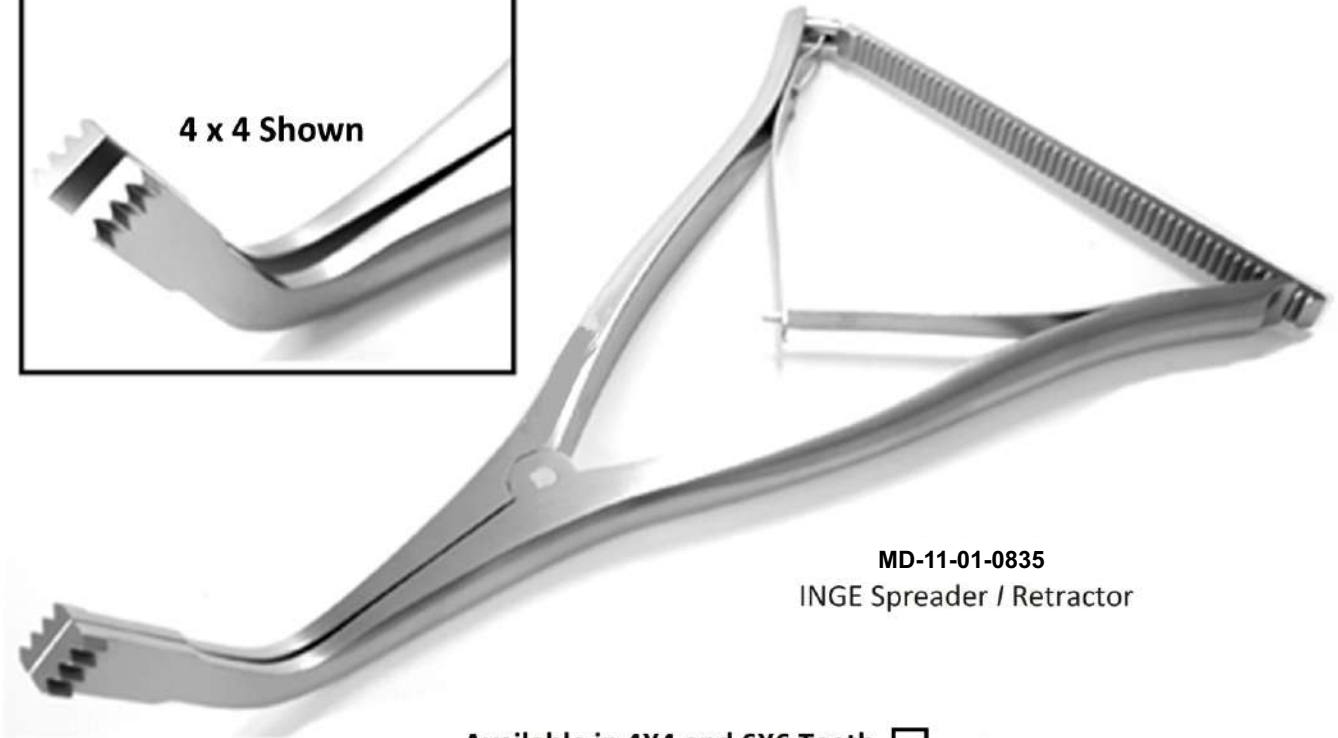
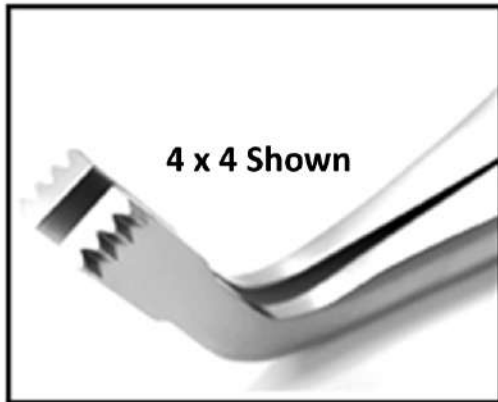

**MD-11-01-0835**  
INGE Spreader / Retractor

Available in 4X4 and 6X6 Teeth  
& Without Teeth (Plain)

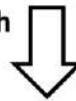

**A: 4X4 Teeth**  
**B: Without Teeth**  
16.5 cm / 6 1/2"

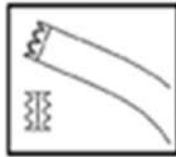

**C: 4X4 Teeth**  
**D: Without Teeth**  
25.5 cm / 10"

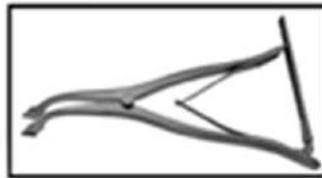

**10 Inch Length Pattern**

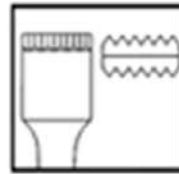

**A: 6X6 Teeth**  
**B: Without Teeth**  
27 cm / 10 1/2"  
Flat Blades



**C: 6X6 Teeth**  
**D: Without Teeth**  
27 cm / 10 1/2"  
Concave Blades



**MD-11-01-0836-1**  
Offset Lamina Spreader / Retractor  
25.5 cm / 10"

## LAMINA SPREADERS - RETRACTORS

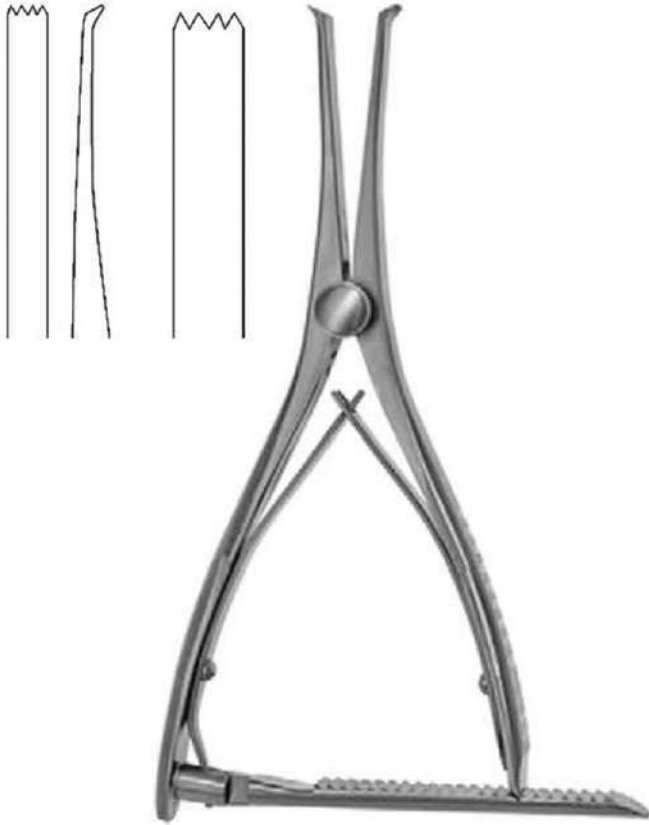

**MD-11-01-0836-2**

Vertebra Spreader / Retractor  
A: 18 cm / 7" | B: 28 cm / 11"



**MD-11-01-0837**

Inge Spreader  
Serrated Outside Blades 18 cm / 7"



**MD-11-01-0838**

Saxsena Lamina Spreader / Retractor  
A: 18 cm / 7" | B: 25.5 cm / 10"  
Serrated Outside Blades

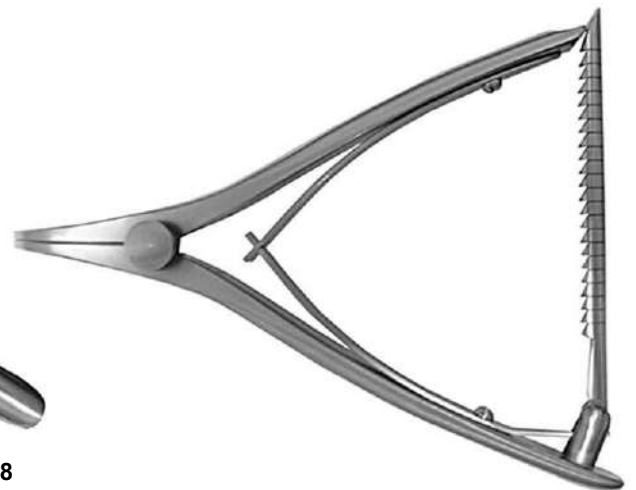

## CALCANEAL – LAMBARDI SPREADERS



**MD-11-01-0839**  
Calcaneal Spreader  
Smooth Pads 15X12mm  
18 cm / 7"



**MD-11-01-0840**  
Calcaneal Spreader  
Grooved Pads 15X12mm  
18 cm / 7"



**MD-11-01-0841**  
Lombardi Femoral Tibial Spreader (Small)  
**A:** Grooved Pads 22X13mm 18 cm / 7"  
**B:** Diamond Cut Pads 22x13mm / 7"



**B:** Diamond Cut Pads 22X13mm



**B:** Diamond Cut Pads 22X13mm



**MD-11-01-0842**  
Lombardi Femoral Tibial Spreader (Large)  
**A:** Grooved Pads 22X13mm 23.5 cm / 9 ¼"  
**B:** Diamond Cut Pads 22x13mm / 9 ¼"

## COMPRESSORS - DISTRACTORS



**MD-11-01-0843**  
Distracting Forceps 23 cm / 9"  
Long Ratchet / Spiral Spring  
For Screws and Rods



**MD-11-01-0844**  
Compressing Forceps 28 cm / 11"  
Adjustable Locking  
For Screws and Rods

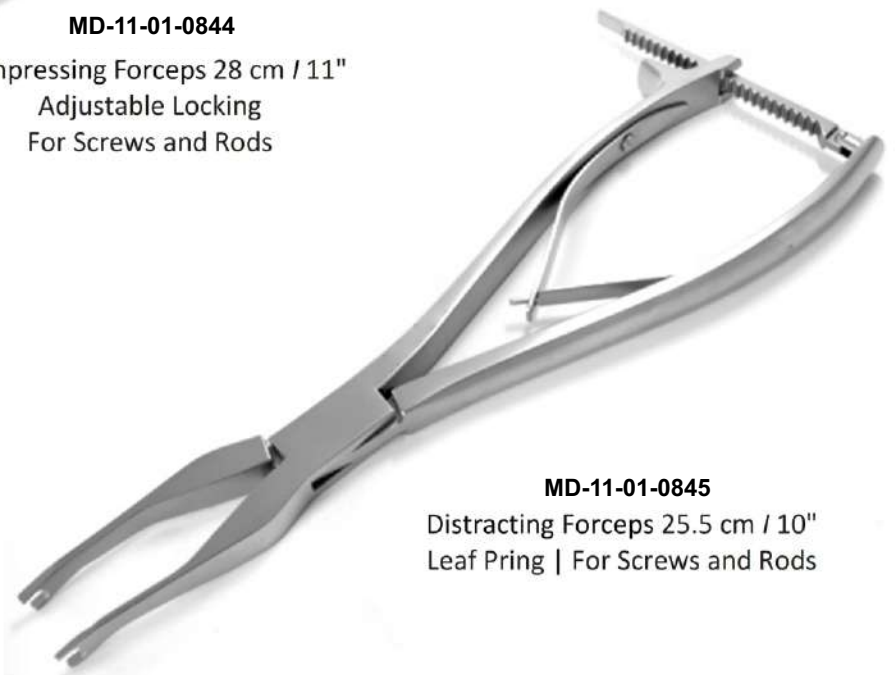

**MD-11-01-0845**  
Distracting Forceps 25.5 cm / 10"  
Leaf Spring | For Screws and Rods

## COMPRESSORS - DISTRACTORS



**MD-11-01-0846**  
Distractor 25.5 cm / 10"  
Leaf Pring | For Screws and Rods



**MD-11-01-0847**  
Compression Forceps  
28 cm / 11"  
Leaf Pring / Long Ratchet  
For Screws and Rods

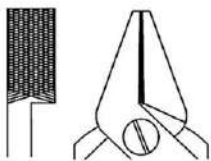

Non TC



**MD-11-01-0848**  
Jet Wire Twisting Device  
28 cm / 11" - 10mm Tip



## ROD BENDERS

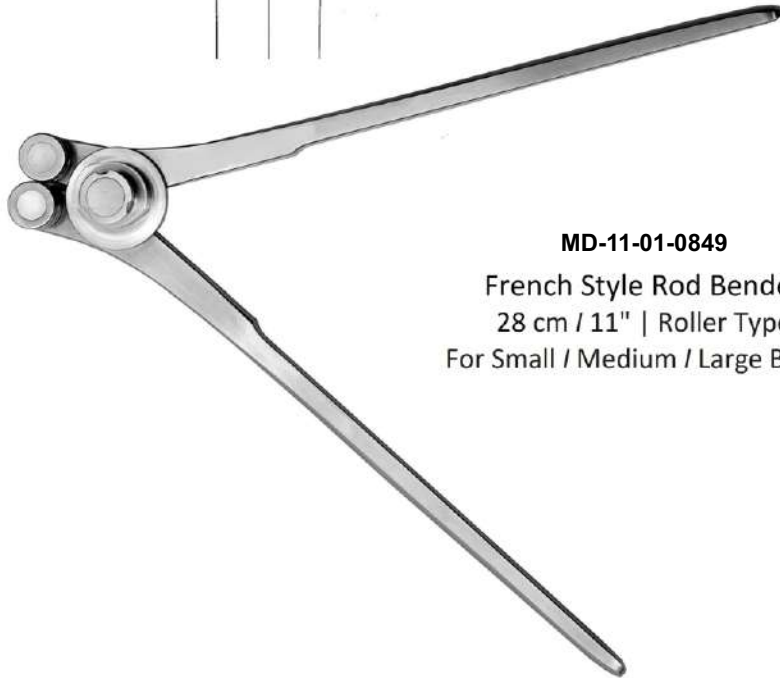
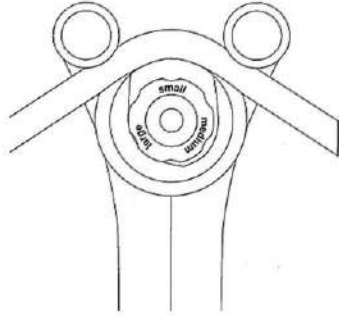

**MD-11-01-0849**  
French Style Rod Bender  
28 cm / 11" | Roller Type  
For Small / Medium / Large Bends

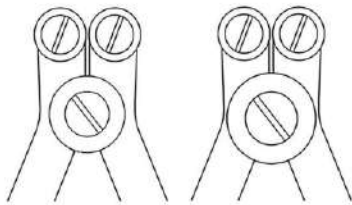

For 4mm Rod

For 3mm Rod

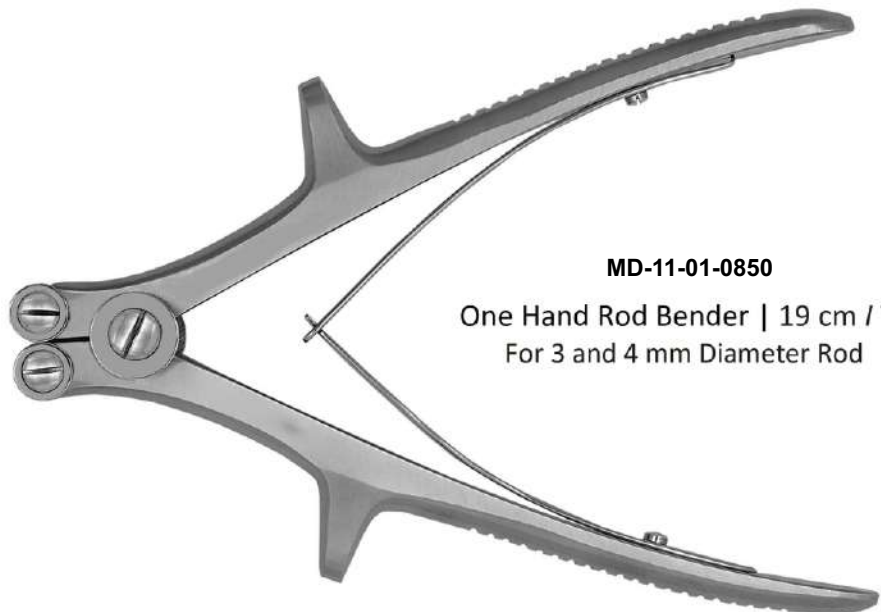

**MD-11-01-0850**  
One Hand Rod Bender | 19 cm / 7"  
For 3 and 4 mm Diameter Rod

## CARBIDE INSERTED WIRE - PIN CUTTING PLIERS

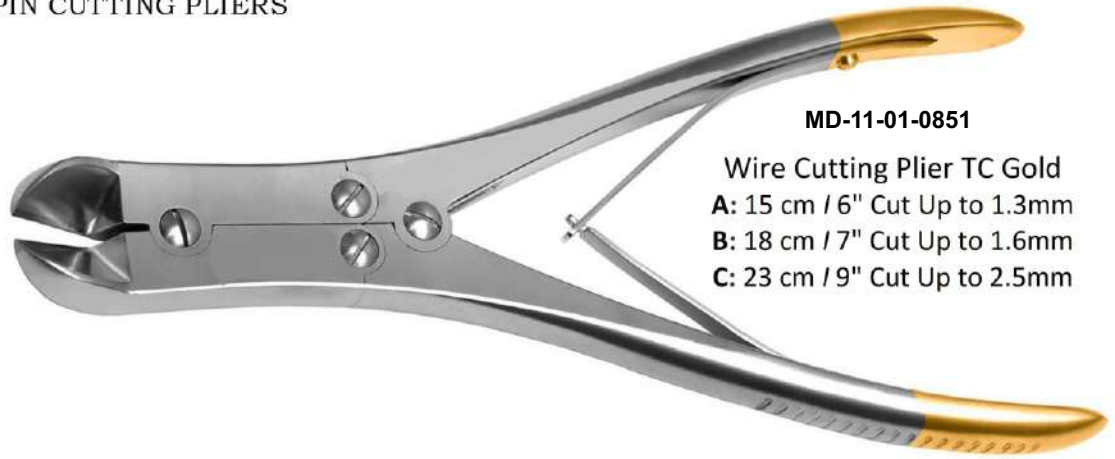
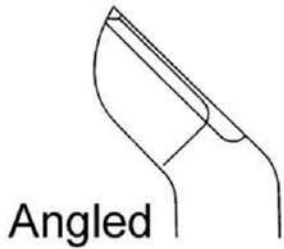

**MD-11-01-0851**

Wire Cutting Plier TC Gold  
A: 15 cm / 6" Cut Up to 1.3mm  
B: 18 cm / 7" Cut Up to 1.6mm  
C: 23 cm / 9" Cut Up to 2.5mm

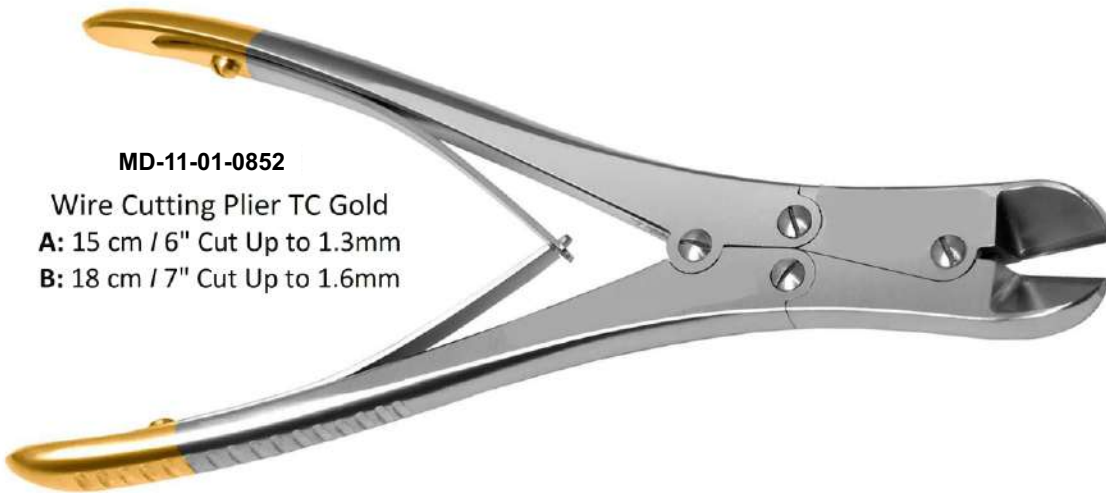

**MD-11-01-0852**

Wire Cutting Plier TC Gold  
A: 15 cm / 6" Cut Up to 1.3mm  
B: 18 cm / 7" Cut Up to 1.6mm

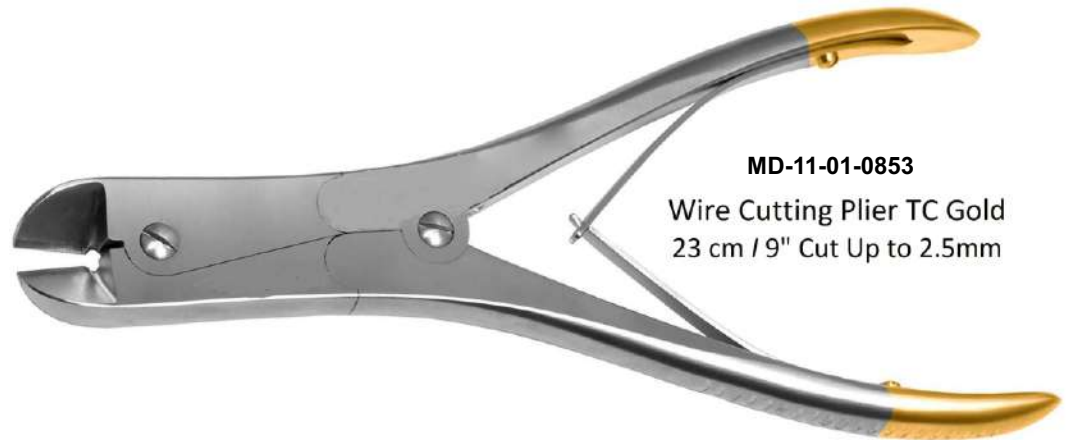

**MD-11-01-0853**

Wire Cutting Plier TC Gold  
23 cm / 9" Cut Up to 2.5mm



**MD-11-01-0854**

Wire Cutting Plier TC Gold  
18 cm / 7" Cut Up to 1.6mm

## CARBIDE INSERTED WIRE – PIN CUTTING PLIERS



**MD-11-01-0855**  
Cannulated Pin Cutter TC Gold  
18 cm / 7" Cut Up to 1.5mm

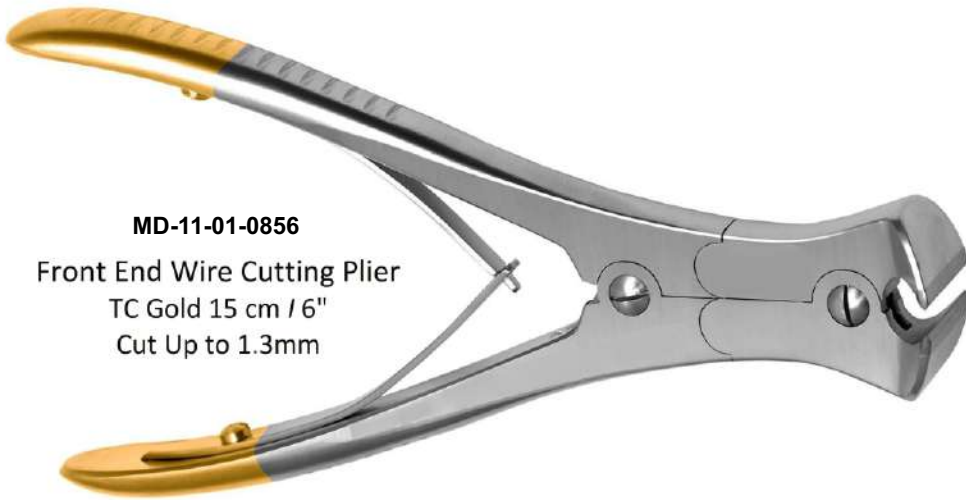

**MD-11-01-0856**  
Front End Wire Cutting Plier  
TC Gold 15 cm / 6"  
Cut Up to 1.3mm



**MD-11-01-0857**  
Front End Wire Cutting Plier  
TC Gold 23 cm / 9"  
Cut Up to 2.5mm

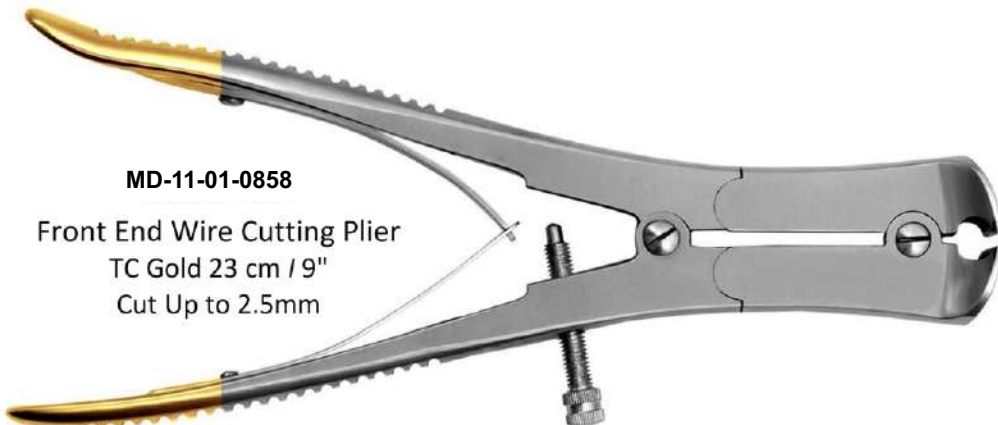

**MD-11-01-0858**  
Front End Wire Cutting Plier  
TC Gold 23 cm / 9"  
Cut Up to 2.5mm

## CARBIDE INSERTED WIRE – PIN CUTTING PLIERS

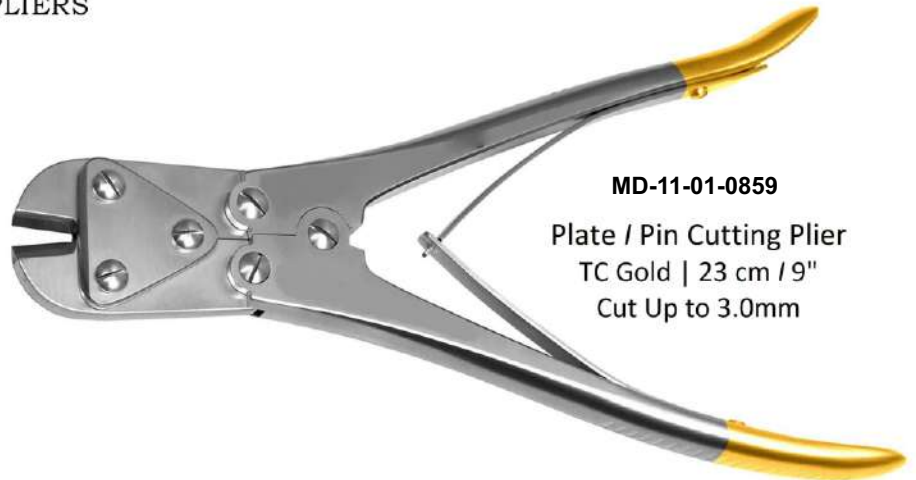

**MD-11-01-0859**  
Plate / Pin Cutting Plier  
TC Gold | 23 cm / 9"  
Cut Up to 3.0mm

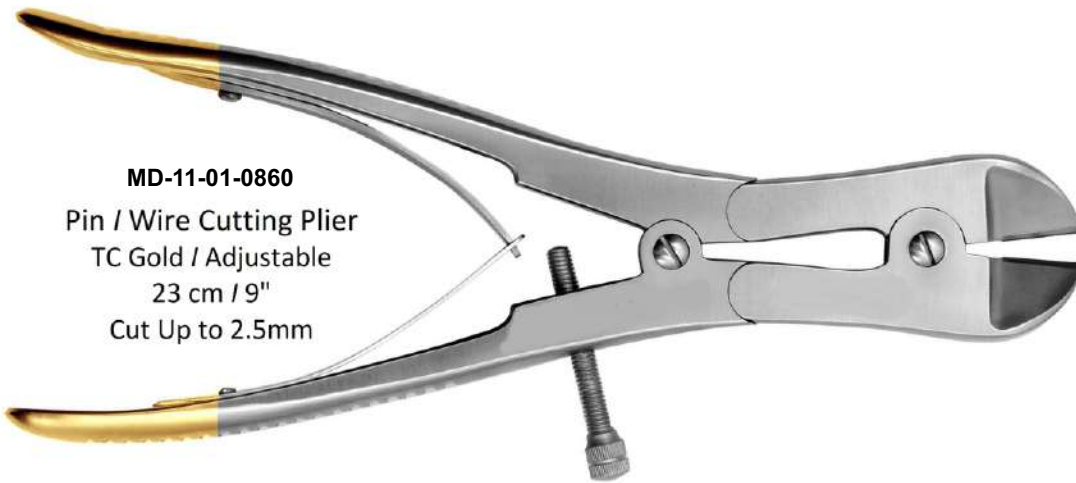

**MD-11-01-0860**  
Pin / Wire Cutting Plier  
TC Gold / Adjustable  
23 cm / 9"  
Cut Up to 2.5mm

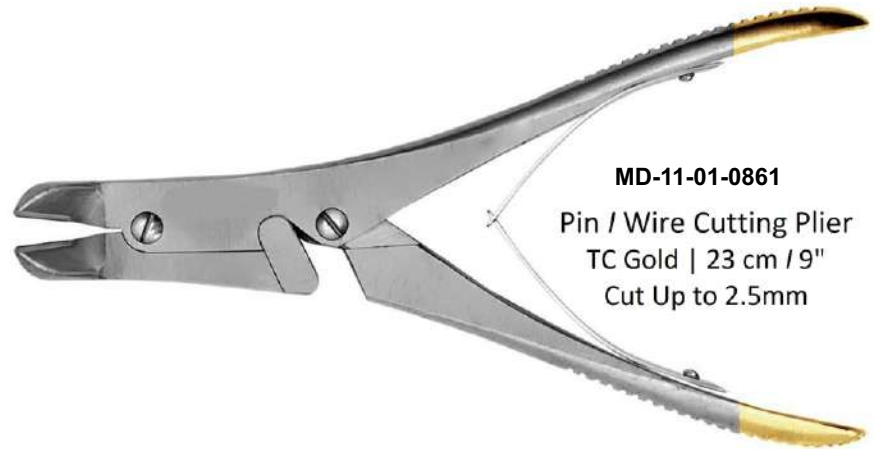

**MD-11-01-0861**  
Pin / Wire Cutting Plier  
TC Gold | 23 cm / 9"  
Cut Up to 2.5mm

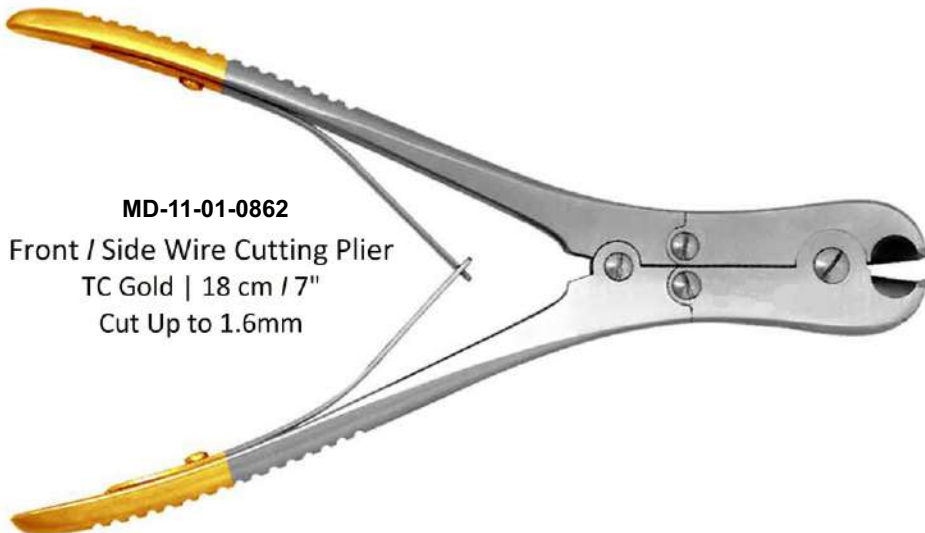

**MD-11-01-0862**  
Front / Side Wire Cutting Plier  
TC Gold | 18 cm / 7"  
Cut Up to 1.6mm

## CARBIDE INSERTED WIRE – PIN CUTTING PLIERS

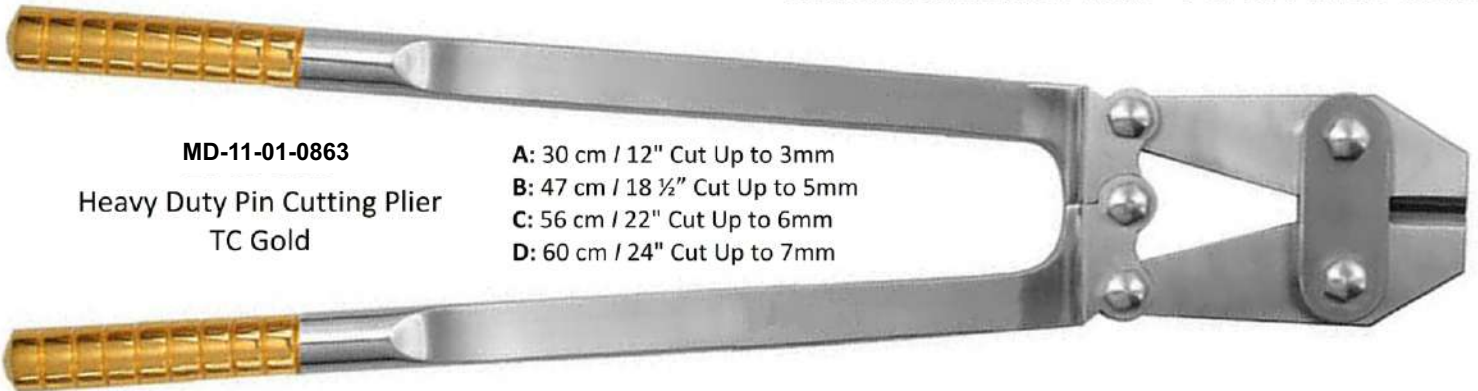

**MD-11-01-0863**  
Heavy Duty Pin Cutting Plier  
TC Gold

- A: 30 cm / 12" Cut Up to 3mm
- B: 47 cm / 18 ½" Cut Up to 5mm
- C: 56 cm / 22" Cut Up to 6mm
- D: 60 cm / 24" Cut Up to 7mm

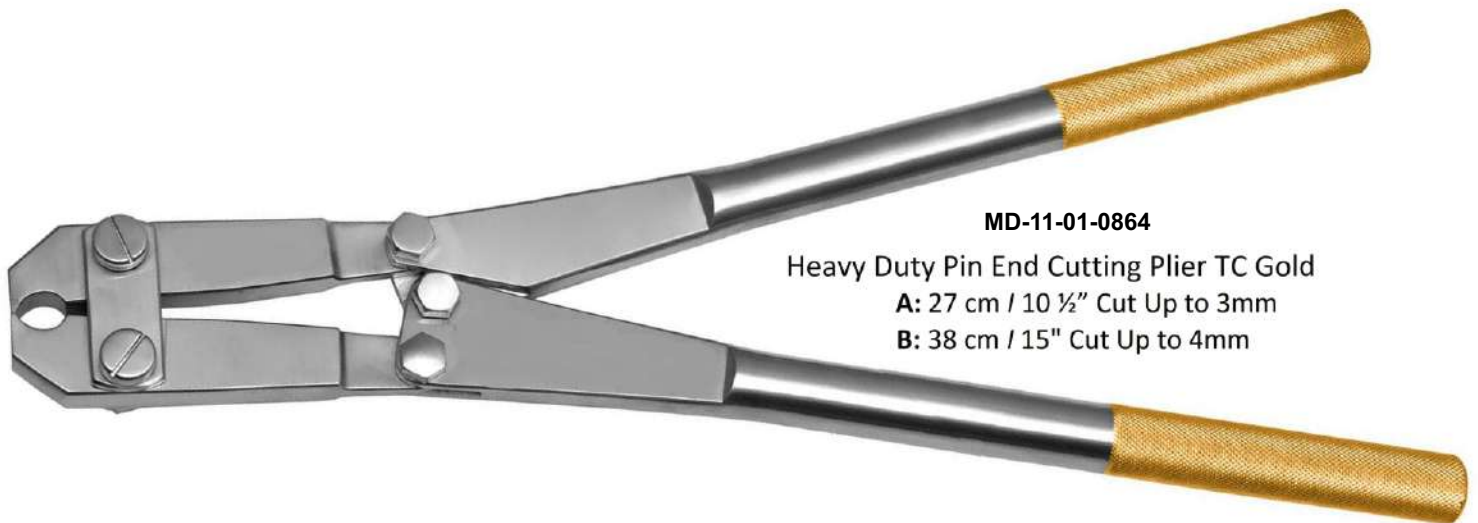

**MD-11-01-0864**  
Heavy Duty Pin End Cutting Plier TC Gold  
A: 27 cm / 10 ½" Cut Up to 3mm  
B: 38 cm / 15" Cut Up to 4mm

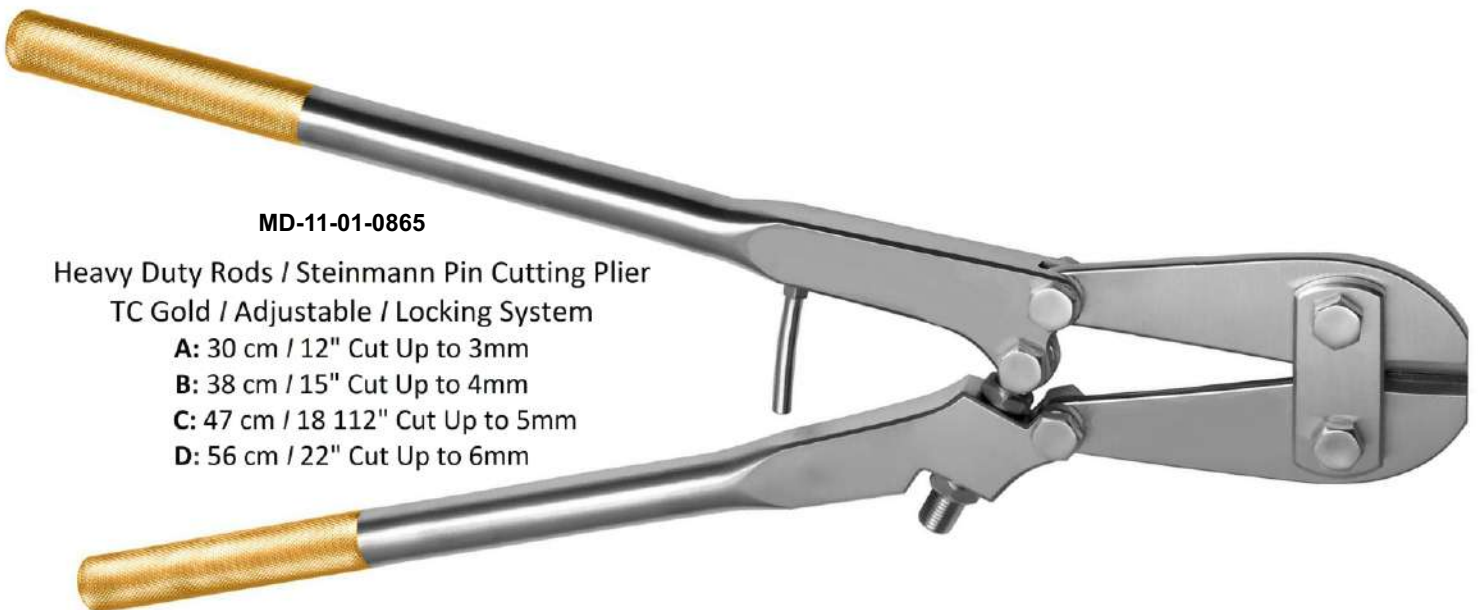

**MD-11-01-0865**  
Heavy Duty Rods / Steinmann Pin Cutting Plier  
TC Gold / Adjustable / Locking System

- A: 30 cm / 12" Cut Up to 3mm
- B: 38 cm / 15" Cut Up to 4mm
- C: 47 cm / 18 1/2" Cut Up to 5mm
- D: 56 cm / 22" Cut Up to 6mm

## CARBIDE INSERTED SURGICAL SCISSORS



A: 15.5 CM / 6"

B: 18 CM / 7"

**MD-11-01-0866**

Wire Twisting Forceps

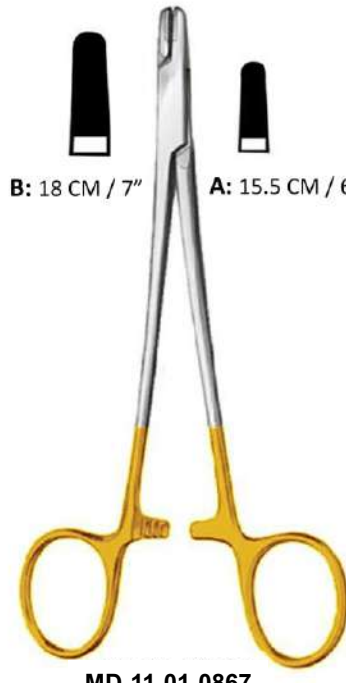

B: 18 CM / 7"

A: 15.5 CM / 6"

**MD-11-01-0867**

Wire Twisting Forceps



B: 20 CM / 8"

A: 15.5 CM / 6"

**MD-11-01-0868**

Wire Twisting Forceps



**MD-11-01-0869**

Corwin Combi-Wire Twisting Forceps 18.5 cm / 7 1/4"



**MD-11-01-0870**

Wire Twisting Forceps  
15.5 cm / 6"

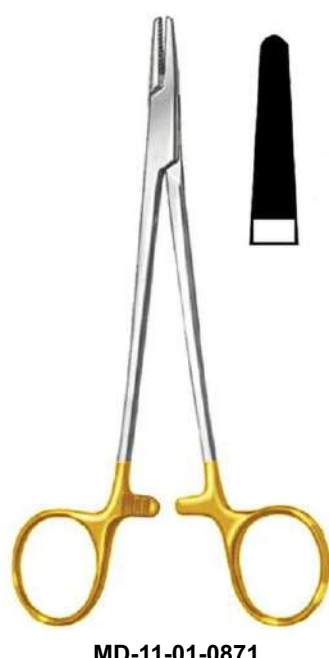

**MD-11-01-0871**

Wire Twisting Forceps  
16 cm / 6 1/4"

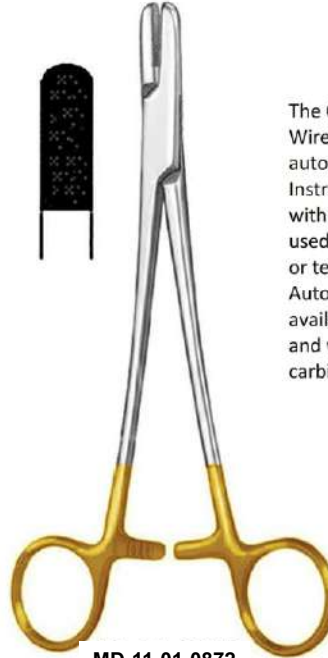

**MD-11-01-0872**

Wire Twisting Forceps  
Heavy Pattern  
19 cm / 7 1/2"

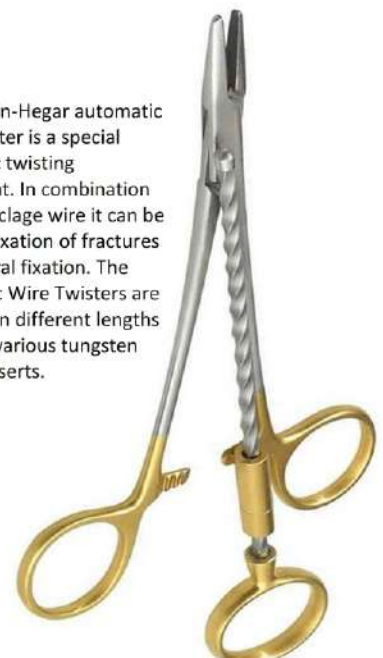

**MD-11-01-0873**

Corwin-Hegar  
Auto Wire Twisting Forceps  
15 cm / 6"

The Corwin-Hegar automatic Wire Twister is a special automatic twisting Instrument. In combination with a cerclage wire it can be used for fixation of fractures or temporal fixation. The Automatic Wire Twisters are available in different lengths and with various tungsten carbide inserts.



**CARBIDE INSERTED SURGICAL SCISSORS**

Blunt / Blunt

- A: 14.5 cm / 5 ¾" Str or Cvd
- B: 17 cm / 6 ¾" Str or Cvd
- C: 23 cm / 9" Str or Cvd



**MD-11-01-0874**  
Mayo Scissors TC Gold

-  Sharp / Sharp  
Cvd or Str
-  Blunt / Blunt  
Cvd or Str
-  Sharp / Blunt  
Cvd or Str

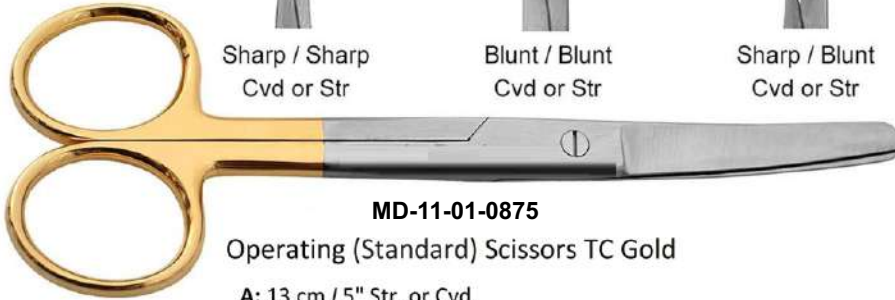

**MD-11-01-0875**  
Operating (Standard) Scissors TC Gold

- A: 13 cm / 5" Str. or Cvd
- B: 14 cm / 5 1/2" Str. or Cvd
- C: 15.5 cm / 6 1/2" Str. or Cvd
- D: 18 cm / 7" Str. or Cvd

Blunt / Blunt

- A: 14.5 cm / 5 ¾" Str. or Cvd.
- B: 17 cm / 6 ¾" Str. or Cvd.
- C: 23 cm / 9" Str. or Cvd.



**MD-11-01-0876**  
Mayo Stille Scissors TC Gold

- A: 14 cm / 5 ½" Str. or Cvd
- B: 17 cm / 6 ¾" Str. or Cvd
- C: 20 cm / 8" Str. or Cvd
- D: 23 cm / 9" Str. or Cvd

Blunt / Blunt

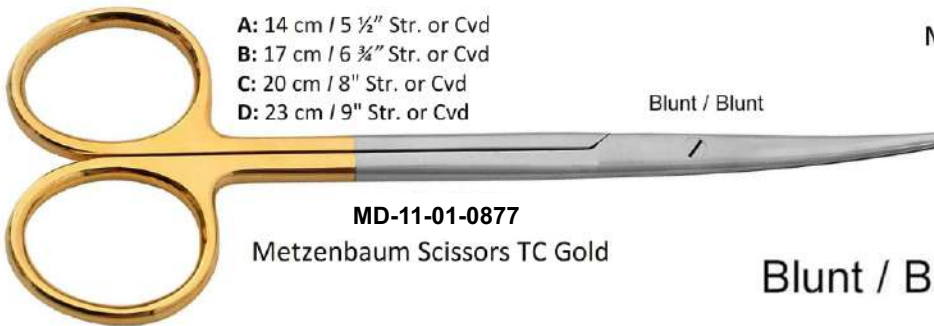

**MD-11-01-0877**  
Metzenbaum Scissors TC Gold

Blunt / Blunt

- A: 20 cm / 8" Str. or Cvd
- B: 23 cm / 9" Str. or Cvd
- C: 28 cm / 11" Str. or Cvd
- D: 30 cm / 12" Str. or Cvd



**MD-11-01-0878**  
Mayo-Harrington Scissors TC Gold



**MD-11-01-0879**  
Ortho Universal Scissors TC Gold  
12 cm / 4 1/3"



**MD-11-01-0880**  
Mayo-Nobel Scissors TC Gold  
16.5 cm / 6 ½" Str. or Cvd

## INSTRUMENTS FOR TRUAMATOLOGY



**Drill Bits for Quick Coupling**

Drill bit 1.1mm dia.  
for threaded hole for 1.5mm screws

Drill bit 1.5mm dia.  
For threaded hole for 2.0mm screws and gliding hole for 1.5mm  
Screws

Drill bit 2.0mm dia.  
For threaded hole for 2.7mm dia.

For gliding hole for 2.7mm screws

<u>Item</u>	<u>Diameter</u>	<u>Total length</u>	<u>Usable length</u>
100.001	1.1mm	060mm	035mm
100.002	1.5mm	085mm	060mm
100.003	1.5mm	110mm	085mm
100.004	2.0mm	100mm	145mm
100.005	2.0mm	125mm	100mm
100.006	2.7mm	100mm	075mm
100.007	2.7mm	125mm	100mm
100.008	2.7mm	100mm	075mm
100.009	2.0mm	125mm	100mm

Drill bit 2.5mm dia.  
For threaded hole for 3.5 and 4.0mm screws

Drill bit 3.5mm  
for gliding hole for 3.5mm screws

<u>Item</u>	<u>Diameter</u>	<u>Total length</u>	<u>Usable length</u>
100.010	2.5mm	110mm	085mm
100.011	2.5mm	180mm	155mm
100.012	3.5mm	100mm	085mm
100.013	3.5mm	195mm	170mm

Drill bit 3.2mm dia.  
For threaded hole for 4.5 and 6.5mm screws

Drill bit 4mm dia.  
For gliding hole for 4.5mm screws

<u>Item</u>	<u>Diameter</u>	<u>Total length</u>	<u>Usable length</u>
100.014	2.0mm	100mm	145mm
100.015	3.2mm	225mm	200mm
100.016	3.2mm	145mm	120mm
100.017	3.2mm	195mm	170mm
100.018	4.5mm	145mm	120mm
100.019	4.5mm	195mm	170mm



**Drill Bit for Jacobs chuck**

<u>Item</u>	<u>Diameter</u>	<u>Total length</u>	<u>Usable length</u>
101.001	1.1mm	45mm	30mm
101.002	1.5mm	70mm	55mm
101.003	2.0mm	85mm	70mm
101.004	2.5mm	95mm	80mm
101.005	2.7mm	85mm	70mm
101.006	3.2mm	130mm	115mm
101.007	3.2mm	180mm	165mm
101.008	3.5mm	95mm	80mm
101.009	3.5mm	180mm	165mm
101.010	4.5mm	130mm	115mm
101.011	4.5mm	180mm	165mm



**MD-11-01-0881**

Tap for 1.5mm Cortex Screws  
Total length 50mm, thread length 20mm  
predrilling 1.1mm dia.



**MD-11-01-0882**

Tap for 6.5mm Cancellous Bone Screws  
Length 195mm, predrilling 3.2mm dia.

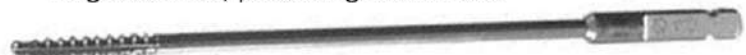

**MD-11-01-0883**

Tap for 4.0mm Cancellous Bone Screws  
Total Length 110mm, Usable Length 85mm



**MD-11-01-0884**

Tap Cannulated, for 7.0mm Cannulated Screws  
Length 230mm



## INSTRUMENTS FOR TRUAMATOLOGY



Tap for 2.0mm Cortex Screws  
Predrilling: 1.5mm dia.

Tap for 2.7mm Cortex Screws  
Predrilling: 2.0mm dia.

Item	Thread	length
102.001	24mm	053mm
102.002	38mm	100mm

Item	Thread length	Total length
102.005	33mm	100mm
102.006	40mm	150mm

Tap for 3.5mm Cortex Screws  
Predrilling: 2.5mm dia.

Item	Total length	Type
102.007	175mm	with length markings
102.008	110mm	thread length 50mm

Predrilling: 3.2mm

Item	Length	Type
102.003	125mm	thread length 70mm
102.004	175mm	with length markings

### 102.009

Tap for 3.5mm Cortex Screws  
**Total Length:** 110mm  
**Thread Length:** 50mm  
**Predrilling:** 3.2mm dia.

### 102.010

Tap for 2.7mm Cortex Screws  
**Total length:** 125mm  
**Thread length:** 40mm  
**Predrilling:** 2.0mm dia.

### 102.011

Tap for 4.5mm Cortex Screws  
**Total length:** 125mm  
**Thread length:** 70mm  
**Predrilling:** 3.2mm dia.



**MD-11-01-0885**  
Countersink Shaft 1.5/2.0  
Length 52mm, for mini quick coupling



**MD-11-01-0886**  
Router, for Jacobs chuck  
Length 90mm



**MD-11-01-0887**  
Router, for quick coupling  
Length 90mm



**MD-11-01-0888**  
Countersink Shaft 3.5mm  
Length 72mm, for quick coupling,  
to countersink the screw head

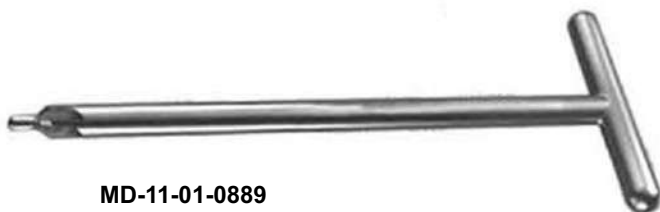

**MD-11-01-0889**  
Countersink, large  
Length 180mm, for 4.5mm cortex screws



**MD-11-01-0890**  
Dountersink, cannulated, for 7.0mm cannulated Screws  
Length 230mm

## INSTRUMENTS FOR TRUAMATOLOGY



**MD-11-01-0891**

Screwdriver Shaft, hexagonal, small  
Length 100mm, for quick coupling  
For 2.7 to 4.0mm screws.



**MD-11-01-0892**

Screwdriver Shaft, Hexagonal, large  
Length 100mm, final tightening of the screw has to  
be done by hand.



**MD-11-01-0893**

Screwdriver Shaft, hexagonal, with Holding Sleeve  
For 1.5 and 2.0mm stainless steel screws  
With hexagonal socket,



**MD-11-01-0894**

Screwdriver Shaft, cruciform, 1.5/ 2.0, with Holding Sleeve  
Length 50mm, for 1.5 and 2.0mm



**MD-11-01-0895**

T-Handle with Coupling  
Length: 80mm, for taps



**MD-11-01-0896**

Screwdriver, hexagonal, with T-Handle,  
Large to loosen tight screws.  
A normal screwdriver can be  
additionally inserted in the hollow  
shaft of the T-handle.



**MD-11-01-0897**

Handle with mini quick coupling



**MD-11-01-0898**

Hand Chuck for Kirschner Wires  
Length 145mm, Spannbereich 0.6 to 1.6mm dia.



**MD-11-01-0899**

Handle with quick coupling  
Length 110mm, for countersinks and  
Instruments for the removal of damaged screws



**MD-11-01-0900**

Handle, small, with mini quick coupling

## INSTRUMENTS FOR TRUAMATOLOGY



**MD-11-01-0901**  
Handle, medium, with mini quick coupling



**MD-11-01-0902**  
Handle, Large, with mini quick coupling



**MD-11-01-0903**  
Screwdriver, hexagonal, small with groove  
Length 200mm, for 2.7 to 4.0mm screws



**MD-11-01-0904**  
Screwdriver with Universal Joint, large  
Length 290mm



**MD-11-01-0905**  
Screwdriver, hexagonal, large, with groove  
Length 240mm



**MD-11-01-0906**  
Screwdriver, hexagonal, with Holding Sleeve,  
Length 165mm for 1.5 and 2.0mm stainless  
Steel screws with hexagonal socket



**MD-11-01-0907**  
Screwdriver, hexagonal, small, with Holding Sleeve  
Length 200mm



**MD-11-01-0908**  
Holding Sleeve for Mini Screws single



**MD-11-01-0909**  
Holding Sleeve



**MD-11-01-0911**  
Holding Sleeve single



**MD-11-01-0910**  
Allen Key, hexagonal, angled  
For 4.5 to 7.0mm screws



**MD-11-01-0912**  
Allen Key, hexagonal, small, angled  
Length 65mm, for 2.7 to 4.0mm screws

INSTRUMENTS FOR TRUAMATOLOGY



**MD-11-01-0913**  
Insert Drill Sleeve 3.5/2.5  
Length 42mm, drill bit 2.5mm dia.



**MD-11-01-0915**  
Trocar 2.0mm dia., Length 118mm, for percutaneous insertion of 7.0mm cannulated screws



**MD-11-01-0917**  
Drill Sleeve 4.5/ 2.0  
Length 109mm, for percutaneous insertion of 7.0mm cannulated screws



**MD-11-01-0918**  
Handle for Drill Guides single



**MD-11-01-0919**  
Drill Sleeve 3.0 with point length 55mm



**MD-11-01-0923**  
Double Drill Sleeve 1.5/101  
For 1.5mm cortex screws  
Drill bits, 1.5 and 1.1mm dia.



**MD-11-01-0925**  
Double Drill Sleeve 2.7/2.0  
For 2.7mm cortex screws



**MD-11-01-0914**  
Insert Drill Sleeve 4.5/3.2  
Length 80mm for long lag screws



**MD-11-01-0916**  
Drill Sleeve 8.0/4.5  
Length 100mm, for percutaneous insertion of 7.0mm cannulated screws



**MD-11-01-0920**  
Handle for Drill Guides single

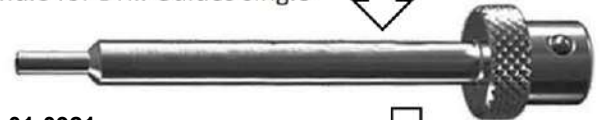

**MD-11-01-0921**  
Drill Sleeve 1.5mm / 2.0 / 2.7mm

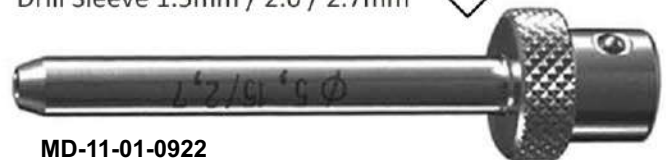

**MD-11-01-0922**  
Drill Sleeve 2.7



**MD-11-01-0924**  
Double Drill Sleeve 2.0/1.5 for  
2.7mm cortex screw



**MD-11-01-0926**  
Double Drill Sleeve 3.5/2.5  
For 3.5mm cortex screws and 4.0mm cancellous bone screws  
Drill bits 3.5 and 2.5 dia.,

## INSTRUMENTS FOR TRUAMATOLOGY



**MD-11-01-0927**  
Double Drill Sleeve 4.5/3.2  
For 4.5mm cortex screws  
Drill bits: 4.5 and 3.2mm dia.



**MD-11-01-0928**  
Double Drill Sleeve 6.5/3.2  
For 6.5mm cancellous bone screws  
Drill bit: 3.2mm dia.



**MD-11-01-0929**  
Universal Drill Sleeve 2.7  
Drill bits 2.0 and 2.7mm dia.,  
Suitable for LC-DCP and round hole plates.



**MD-11-01-0930**  
Universal Drill Guide 3.5  
Drill bit 2.5 and 3.5mm dia., and tissue protection  
Suitable for LC-DCP and round hole plates.



**MD-11-01-0931**  
Universal Drill Guide 4.5/3.2  
Drill bits 3.2 and 4.5mm dia.



**MD-11-01-0932**  
DCP Drill Guide 2.0  
For neutral and load position  
Drill bit 1.5mm dia.



**MD-11-01-0933**  
DCP Drill Guide 2.7  
For neutral and load position  
Drill bit 2.0mm dia.



**MD-11-01-0934**  
DCP Drill Guide 3.5  
For neutral a load position, drill bit 2.5m dia.



**MD-11-01-0935**  
DCP Drill Guide 4.5  
For neutral and load position, drill bit 3.2mm dia.



**MD-11-01-0936**  
LC-DCP Drill Guide 3.5  
For neutral a load position, drill bit 2.5mm dia.



**MD-11-01-0937**  
LC-DCP Drill Guide 4.5  
For neutral and load position, drill bit 3.2mm dia.



**MD-11-01-0938**  
DCP Hip Drill Guide 4.5, for neutral and load position, for 4.5mm screws with DHS and angled blade plates, sleeve length 60mm, drill bit 3.2mm dia.

## INSTRUMENTS FOR TRUAMATOLOGY



**MD-11-01-0939**  
Triple Drill Sleeve 2.0  
with 3 holes, opposite side 1 hole

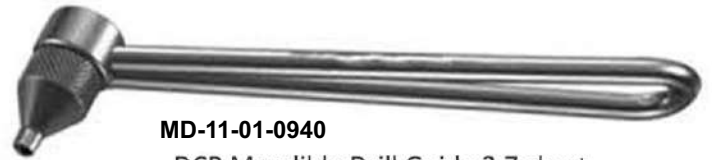

**MD-11-01-0940**  
DCP Mandible Drill Guide 2.7 short  
drill bit 2.0mm dia.



**MD-11-01-0941**  
DCP Mandible Drill Guide 2.7 long  
drill bit 2.0mm dia.



**MD-11-01-0942**  
Insert Drill Sleeve with stop, for 4.5mm screws  
adjustable length to limit drilling depth,  
external dia. 4.5mm for drill bits of 3.2mm dia.



**MD-11-01-0943**  
Parallel drill Guide 4.5  
For percutaneous insertion of 7.0mm cannulated screws



**MD-11-01-0944**  
Parallel Wire Guide 2.0mm dia.



**MD-11-01-0945**  
Depth Gauge for 2.7 to 4.0m screws  
measuring range up to 60mm



**MD-11-01-0948**  
Bending Iron for plates 2.7 and 3.5  
Length 150mm, slid widths 2.5 and 4.5mm, required paris  
Slid placement: 4.5 / 2.5  
Slid placement: 2.5/4.5



**MD-11-01-0946**  
Depth Gauge for 2.7 to 4.0mm screws measuring  
range up to 60mm



**MD-11-01-0947**  
Depth Gauge for 4.5mm to 6.5mm screws measuring  
range up to 110mm



**MD-11-01-0949-1**  
Bending Iron for plates 1.5 and 2.5  
Length: 130mm, slid width: 2.5mm

## INSTRUMENTS FOR TRUAMATOLOGY

**MD-11-01-0949-2**

Triple Drill Guide

130° angle, for 130° angled blade plates and for condylar plates, drill bit 4.5mm dia.



**MD-11-01-0950**

Drill Guide with stop 3.5/2.7 to limit drilling depth



**MD-11-01-0951**

Protection Sleeve 11.0/8.0 for percutaneous insertion of 7.0mm cannulated screws



**MD-11-01-0952**

Holding Sleeve  
Length 80mm, for 2.7 to 4.0mm screws



**MD-11-01-0953**

Holding Sleeve for length 80mm for 2.7mm screws and 3.5mm cannulated screws



**MD-11-01-0955**

Screw Forceps, self-holding  
Length 85mm, to take screws out of the screw racks



**MD-11-01-0954**

Holding Sleeve, large, length 120mm



**MD-11-01-0956**

Drill Sleeve, pointed



**MD-11-01-0957**

Bending Iron LC-DCP/DCP  
Length 250mm, for small and broad LC-DCP, DCP  
Slit widths 5 and 7mm, required in pairs

## INSTRUMENTS FOR TRUAMATOLOGY



**MD-11-01-0958**  
Bending Iron for Kirschner Wires  
Length 120mm, for 1.25 to 2.5mm dia.



**MD-11-01-0959**  
Bending Iron for Kirschner Wires  
Length 115mm, for 0.8 to 1.25mm dia.



**MD-11-01-0960**  
Bending Iron for Reconstruction Plates 3.5 and 4.5  
Length 190mm, required in paris



**MD-11-01-0961**  
Handle with Sleeve  
with rotating drill guide and anchoring point



**MD-11-01-0962**  
Trocar Point, large



**MD-11-01-0964**  
Combination Wrench 11mm length 140mm



**MD-11-01-0963**  
Cheek Retractor Ring



**MD-11-01-0965**  
Pin Wrench, length 120mm, 4.5mm dia.  
For tension device, distractor and knurled  
nut of insertion handle for intramedullary nail



**MD-11-01-0966**  
Socket Wrench 11mm  
Length 200mm



**MD-11-01-0967**  
Slotted Hammer  
Length 270mm



**MD-11-01-0968**  
Inserter/Extractor, with Adjustable Clamps, length 270mm, for the  
insertion and extraction of angled plates for adults and hip plates for  
adolescents and children as well as tibial plateau osteotomy plates.



**MD-11-01-0969**  
Measuring Device  
For drill bits, screws, Kirschner wires,  
and Steinmann pins



## INSTRUMENTS FOR TRUAMATOLOGY



**MD-11-01-0970**  
Inserter/Extractor  
Length 175mm, for infant hip plate and mini hip plate.



**MD-11-01-0971**  
Bending Pliers for Reconstruction Plates 2.7 and 3.5  
Length 240mm



**MD-11-01-0972**  
Bending Pliers for plate 2.4 to 4.0  
Length 230mm



**MD-11-01-0973**  
Cutter for thin plates 1.5 to 2.7  
Length 256mm



**MD-11-01-0974**  
Bending Pliers  
For reconstruction plates 2.7,  
Length 270mm, required in paris



**MD-11-01-0975**  
Cerclage Wire Tightener  
Length 260mm  
For twisting, for temporary fixation during reduction



**MD-11-01-0976**  
Bending Pliers for Plates

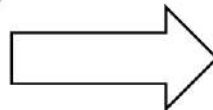

**MD-11-01-0977**  
Anvil, narrow



**MD-11-01-0978**  
Anvil, Large

INSTRUMENTS FOR TRUAMATOLOGY

**MD-11-01-0979**

Bending Press  
Length 400mm



**MD-11-01-0980**

Tension Device, articulated  
Span 20mm, can also be used as a distractor.  
Color scale: yellow up to 500N, green up to 1000N,  
red above 100N.



**MD-11-01-0981**

Chisel Guide  
With adjustable angle



**MD-11-01-0983**

Blade with foot single

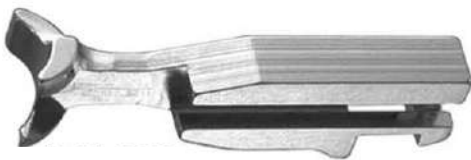

**MD-11-01-0984**

Blade with tip single

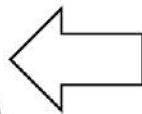
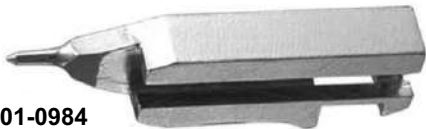

**MD-11-01-0982**

Forceps with Sliding Blades  
Complete with two interchangeable blades  
Length 155mm, weight 42 g, speed lock

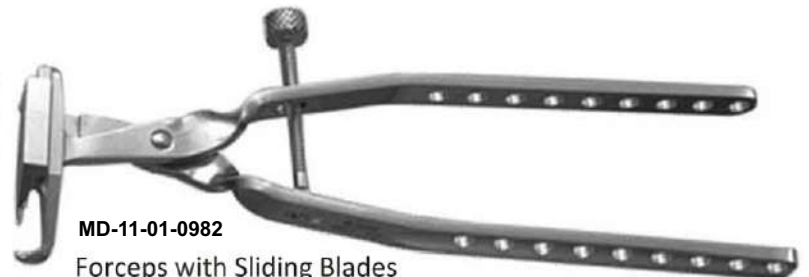

**MD-11-01-0985**

Wire Passer 45mm bending diameter



**MD-11-01-0986**

Wire Passer 70mm bending diameter



**MD-11-01-0987**

Holding Clip



**MD-11-01-0988**

Wire Tightener  
Length 240mm, with handle and two pegs



## INSTRUMENTS FOR TRUAMATOLOGY



**MD-11-01-0989**

Handle with quick coupling  
Length 150 mm



**MD-11-01-0990**

Cancellous Bone Impactor, curved, 6mm dia.  
Length 140 mm



**MD-11-01-0991**

Cancellous Bone Impactor, curved, 6mm dia.  
Flattened, Length 140 mm



**MD-11-01-0992**

Cancellous Bone Impactor, straight, 8 mm dia.  
Length 140 mm



**MD-11-01-0993**

Cancellous Bone Impactor, rectangular,  
6x16mm, Length 140 mm



**MD-11-01-0994**

Cancellous Bone Impactor, rectangular,  
10x20mm, Length 140mm



**MD-11-01-0995**

Cancellous Bone Impactor, rectangular,  
10x30mm, Length 140 mm



**MD-11-01-0996**

Rasp round  
Length: 140 mm



**MD-11-01-0997**

Rasp, half-round  
Length: 140 mm



**MD-11-01-0998**

Gouge, straight, 5mm wide  
Length 140 mm



**MD-11-01-0999**

Gouge, curved, 5mm wide  
Length 140 mm



**MD-11-01-1000**

Gouge, straight, 10 mm wide  
Length 140mm



**MD-11-01-1001**

Gouge, curved, 10 mm wide  
Length 140 mm



**MD-11-01-1002**

Gouge, curved, 15 mm wide  
Length 140 mm

## INSTRUMENTS FOR TRUAMATOLOGY



**MD-11-01-1003**

Gouge, straight, 15 mm wide  
Length 140 mm



**MD-11-01-1004**

Chisel, flat, curved, 16 mm wide  
Length 140 mm



**MD-11-01-1005**

Chisel, flat, straight, 16 mm wide  
Length 140 mm



**MD-11-01-1006**

Chisel, flat, curved, 4 mm wide  
Length 140 mm



**MD-11-01-1007**

Chisel, flat, 20 mm wide  
Length 140 mm



**MD-11-01-1008**

Chisel, flat, curved, 8 mm wide  
Length 140 mm



- Basic Orthopedic Instruments ■
- Spinal Instruments ■
- Trauma Instruments ■

# Orthopedic Instruments Catalogue



📍 Ward # 4, Masjid Road, Saddar Bazar, Sialkot Cantt Pakistan

📞 +92-311-7786276    📞 +92-322-9284144    📞 +92-52-4268308

✉ info@mndinstruments.com

🌐 www.mndinstruments.com

