



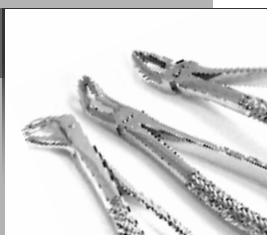
Friendly Specialist  
**SERVICE**



**DENTAL  
INSTRUMENTS  
Catalogue**



01



Extracting Forceps

Page 05-25

02



Orthodontic  
Instruments

Page 26-41

03



Elevators

Page 42-49

04



Scissors

Page 50-55

05



Tweezers, Forceps  
& Needle Holders

Page 56-65

06









Implantology Instruments  
& Mouth Gags

Page 66-87



TABLE OF CONTENTS

Page 88 - 129	Mirror Handles, Scalers & Knives		07
Page 130 - 145	Crown, Ligature & Laboratory Instruments		08
Page 146 - 151	Dental Syringes		09
Page 152 - 157	Impression Trays		10
Page 158 - 169	Holloware / Instruments Trays		11
Page 170 - 173	Articulators		12



# MALLEABLE & DUCTILE

## INSTRUMENTS

**MALLEABLE & DUCTILE**  
INSTRUMENTS

**01**

**Page 5-25**

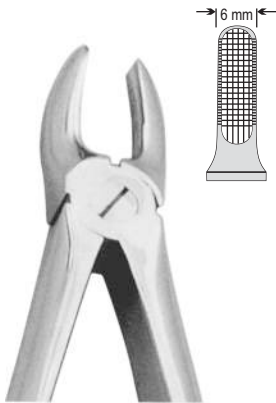
**Extraction**

Extracting Forceps  
Root Elevators  
Luxators  
Periotomes

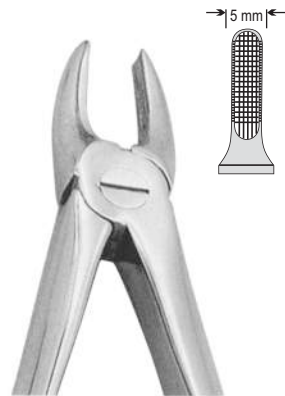




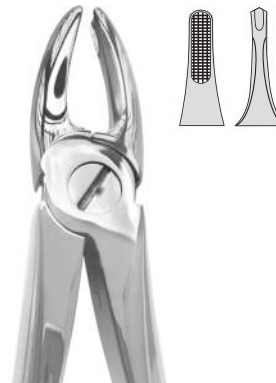
## EXTRACTION FORCEPS STANDARD ENGLISH PATTERN



No. 1  
MD-01-001  
Upper Centrals &  
Canines / Cuspids



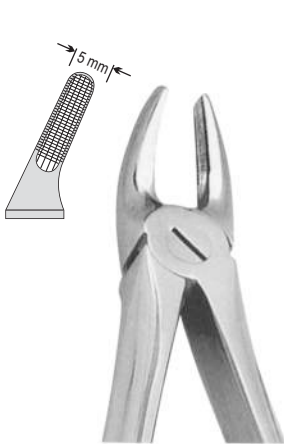
No. 2  
MD-01-002  
Upper Laterals &  
Canines / Cuspids



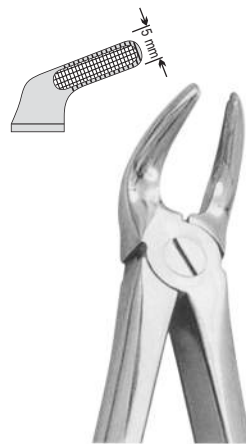
No. 3  
MD-01-003  
Upper Incisors  
& Canines



No. 4  
MD-01-004  
Lower Incisors  
& Cuspids



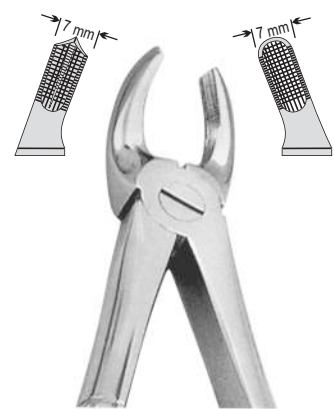
No. 7  
MD-01-005  
Upper Premolars / Bicuspid



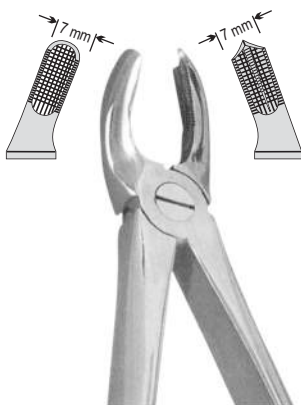
No. 8  
MD-01-006  
Lower Premolars / Bicuspid



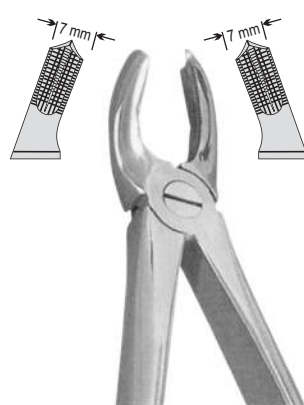
No. 13  
MD-01-007  
Lower Premolars / Bicuspid



No. 17  
MD-01-008  
Upper Molars, Right



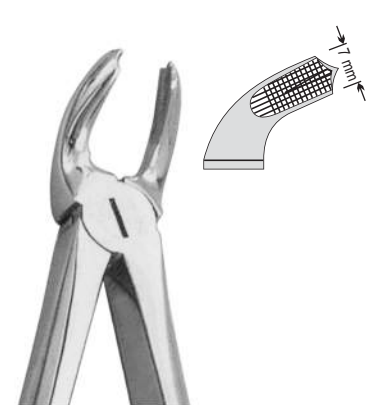
No. 18  
MD-01-009  
Upper Molars, Left



No. 18A  
MD-01-010  
Upper Molars



No. 19  
MD-01-011  
Upper Third Molars



No. 21  
MD-01-012  
Lower Molars



EXTRACTION FORCEPS STANDARD ENGLISH PATTERN



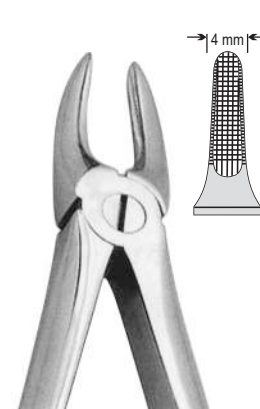
No. 22  
MD-01-013  
Lower Molars



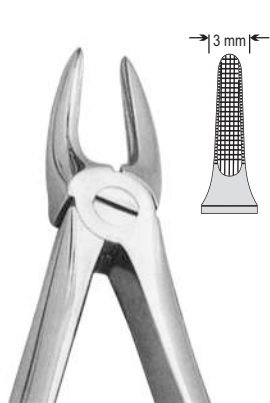
No. 23  
MD-01-014  
Lower Molars  
Right



No. 24  
MD-01-015  
Lower Molars  
Left



No. 29  
MD-01-016  
Upper Roots



No. 29N  
MD-01-017  
Upper Roots



No. 30  
MD-01-018  
Upper Roots



No. 31  
MD-01-019  
Lower Roots



No. 32  
MD-01-020  
Lower Molars



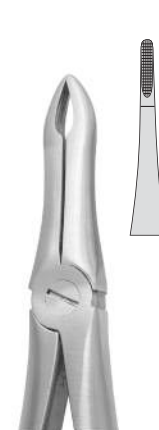
No. 33  
MD-01-021  
Lower Roots



No. 33A  
MD-01-022  
Lower Roots



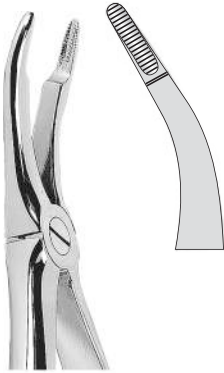
No. 33M  
MD-01-023  
Lower Roots



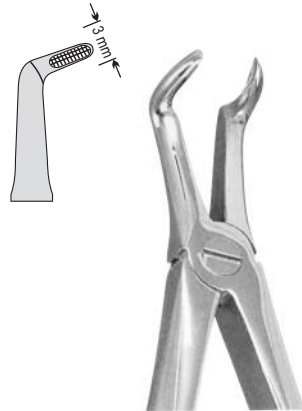
No. 41  
MD-01-024  
Upper Roots



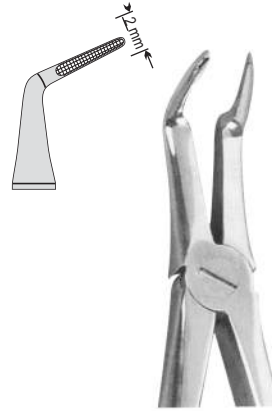
## EXTRACTION FORCEPS STANDARD ENGLISH PATTERN



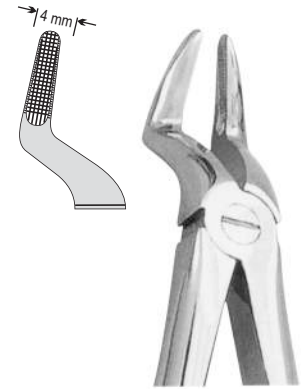
No. 44  
MD-01-025  
Upper Roots



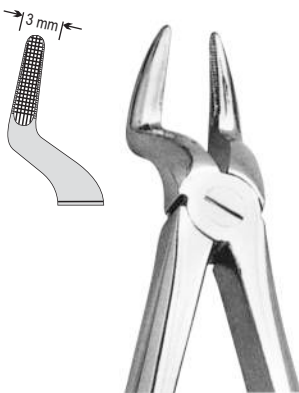
No. 45  
MD-01-026  
Lower Roots



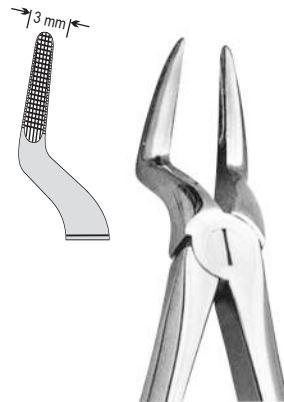
No. 46L  
MD-01-027  
Lower Roots



No. 51  
MD-01-028  
Upper Roots



No. 51A  
MD-01-029  
Upper Roots



No. 51M  
MD-01-030  
Upper Roots



No. 52  
MD-01-031  
Upper Roots



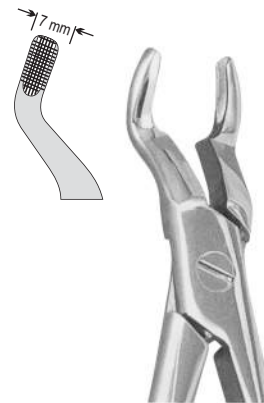
No. 52A  
MD-01-032  
Upper Teeth  
& Resection



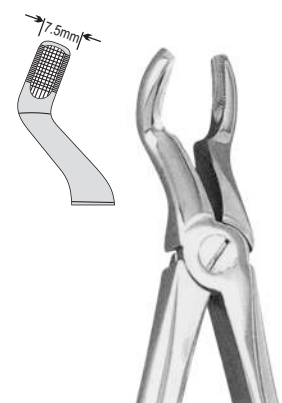
No. 55  
MD-01-033  
For Separating  
Upper Molars



No. 56  
MD-01-034  
For Separating  
Lower Molars



No. 67  
MD-01-035  
Upper Third  
Molars



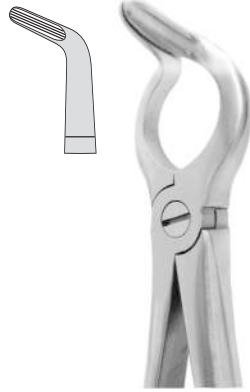
No. 67A  
MD-01-036  
Upper Third  
Molars



EXTRACTION FORCEPS STANDARD ENGLISH PATTERN



No. 68  
**MD-01-037**  
 Lower Roots



No. 68A  
**MD-01-038**  
 Lower Roots



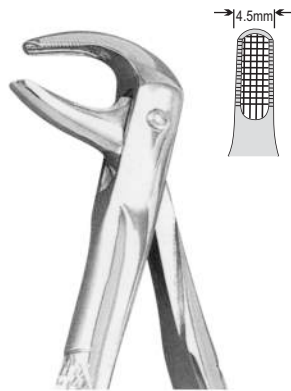
No. 73  
**MD-01-039**  
 Lower Molars



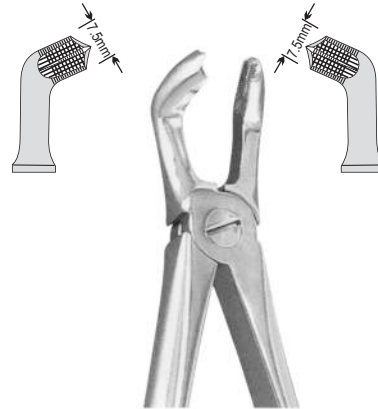
No. 74  
**MD-01-040**  
 Lower Roots



No. 74N  
**MD-01-041**  
 Lower Roots



No. 75  
**MD-01-042**  
 Lower Premolars / Bicuspid



No. 79  
**MD-01-043**  
 Lower Third Molars



No. 79A  
**MD-01-044**  
 Lower Third Molars



No. 86A  
**MD-01-045**  
 Lower Molars



No. 86C  
**MD-01-046**  
 Lower Molars



No. 87  
**MD-01-047**  
 Lower Molars



No. 89  
**MD-01-048**  
 Right Upper Molars



No. 90  
**MD-01-049**  
 Left Upper Molars



## EXTRACTION FORCEPS STANDARD ENGLISH PATTERN



No. 91  
**MD-01-050**  
For Separating  
Lower Molars



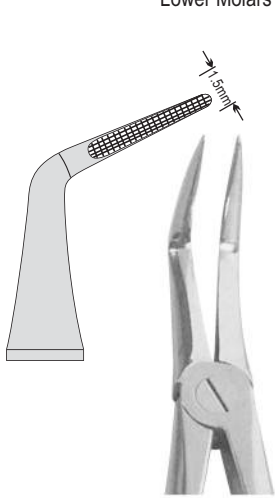
No. 99  
**MD-01-051**  
Lower Molars



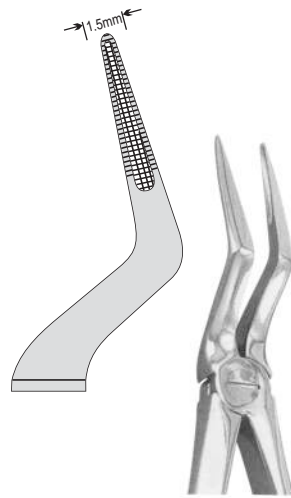
No. 99 1/4  
**MD-01-052**  
Lower Molars



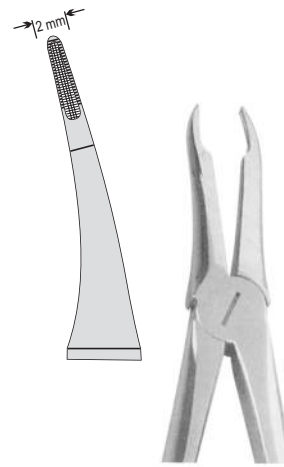
No. 99 1/2  
**MD-01-053**  
Lower Molars



No. 145  
**MD-01-054**  
Very Fine Roots  
Lower



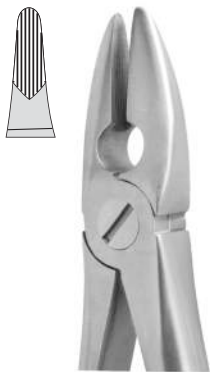
No. 151 1/2  
**MD-01-055**  
Very Fine Roots  
Upper



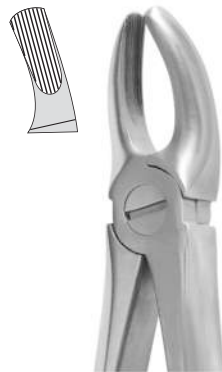
No. 349  
**MD-01-056**  
Very Fine Roots  
Upper



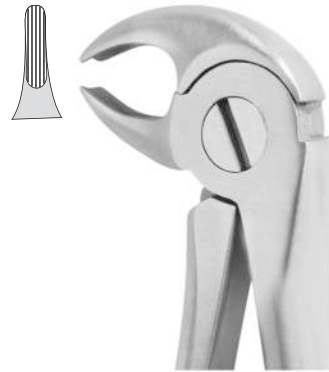
No. 359  
**MD-01-057**  
Very Fine Roots  
Lower



MD 1  
**MD-01-058**  
Incisors, Bicuspid & Roots  
Upper



MD 2  
**MD-01-059**  
Upper Molars



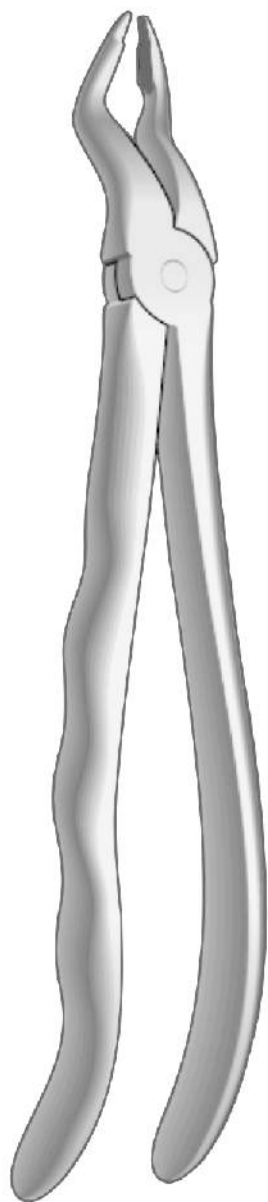
MD 3  
**MD-01-060**  
Incisors, Bicuspid & Roots  
Lower



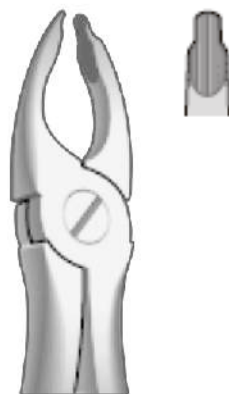
MD 4  
**MD-01-061**  
Lower Molars



EXTRACTION FORCEPS WITH ANATOMICAL GRIP



No. S-31  
MD-01-062  
Upper Premolars



No. 34  
MD-01-063  
Upper Incisors & Cuspids



No. 35  
MD-01-064  
Upper Incisors & Cuspids,  
Deep Gripping



No. 79N  
MD-01-065  
Lower Wisdom Teeth



No. 46N  
MD-01-066  
Lower Premolars



Fig. 36  
MD-01-067  
Lower roots  
Incisors & Cuspids



No. 36N  
MD-01-068  
Lower roots  
Incisors & Cuspids

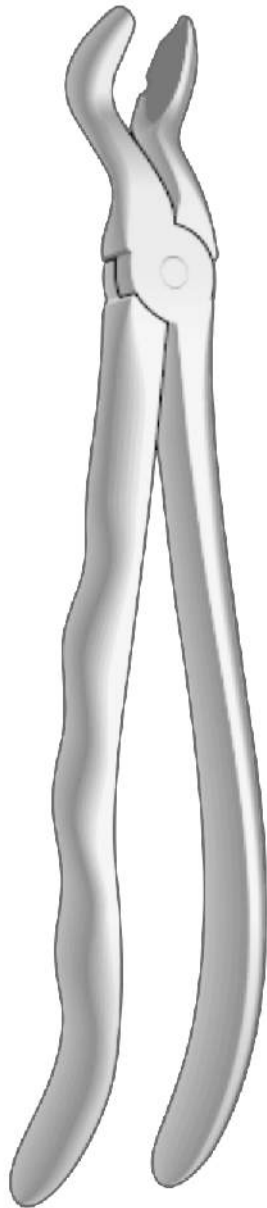


No. 59  
MD-01-069  
Lower Root Fragments

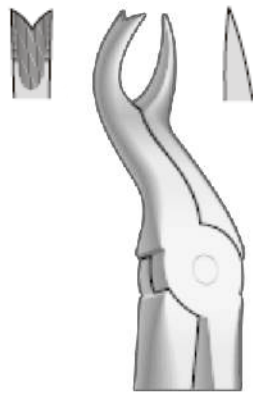




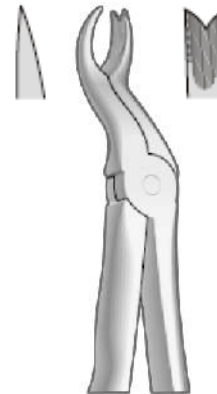
## EXTRACTION FORCEPS WITH ANATOMICAL GRIP



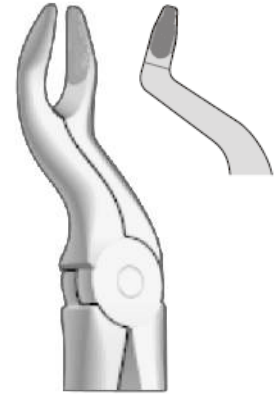
No. 80  
**MD-01-070**  
Felsch  
Upper Wisdom Teeth  
with Retaining Device



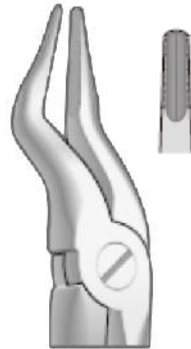
No. 67L  
**MD-01-071**  
Upper Molars  
Left



No. 67R  
**MD-01-072**  
Upper Molars  
Right



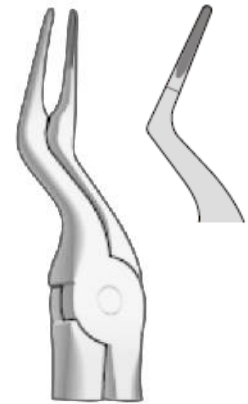
No. 67N  
**MD-01-073**  
Upper Molars



No. 51B  
**MD-01-074**  
Upper Molars



No. 97  
**MD-01-075**  
Upper Root Fragments



No. 97B  
**MD-01-076**  
Upper Root Fragments



No. 122 L  
**MD-01-077**  
Lower Molars & Wisdom Teeth  
Left



No. 122 R  
**MD-01-078**  
Lower Molars & Wisdom Teeth  
Right



No. 133 L  
**MD-01-079**  
Lower Very Fine Roots  
Left



No. 133 R  
**MD-01-080**  
Lower Very Fine Roots  
Right

EXTRACTION FORCEPS CHILDREN PATTERN



No.13S  
**MD-01-081**  
 Lower Premolars



No.22S  
**MD-01-082**  
 Lower Molars



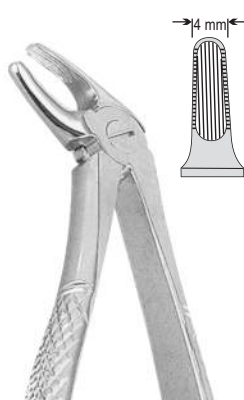
No.30S  
**MD-01-083**  
 Upper Roots



No.33S  
**MD-01-084**  
 Lower Roots



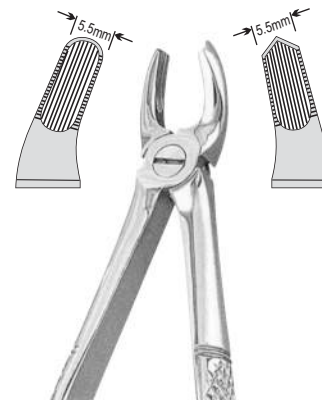
No.37  
**MD-01-085**  
 Upper Incisors



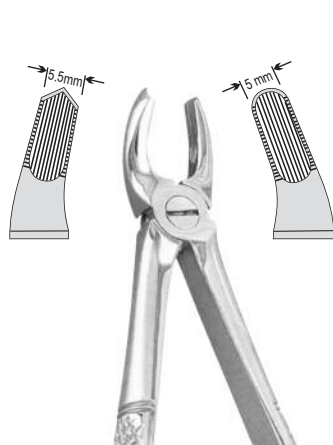
No.38  
**MD-01-086**  
 Lower Incisors and Canines



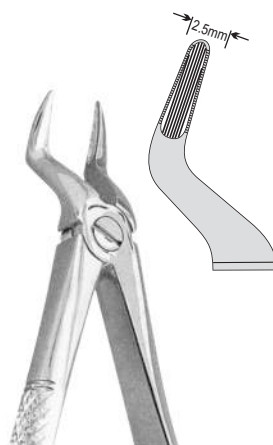
No.39  
**MD-01-087**  
 Upper Molars



No.39L  
**MD-01-088**  
 Upper Molars, left



No.39R  
**MD-01-089**  
 Upper Molars, Right



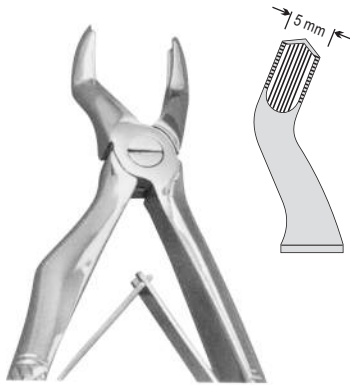
No.51S  
**MD-01-090**  
 Upper Roots



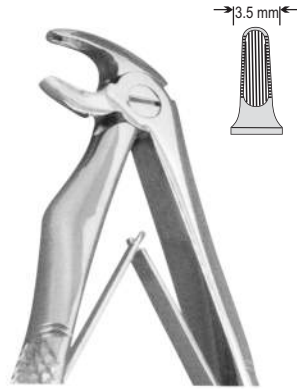
**MD-01-091**  
 Set of 10 pieces



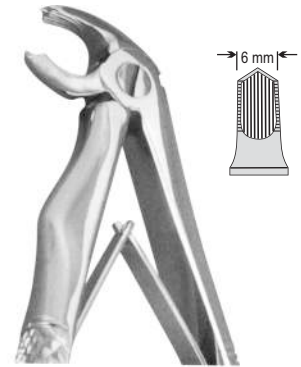
## EXTRACTION FOCEPS CHILDREN PATTERN



No. 52  
MD-01-092  
Upper Molars



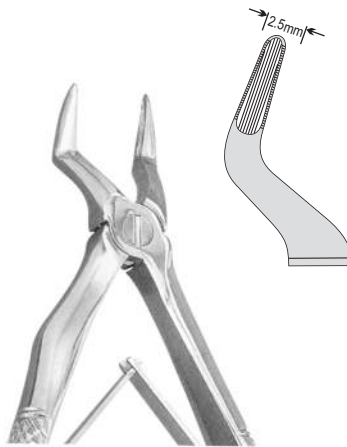
No. 13  
MD-01-093  
Lower Incisors



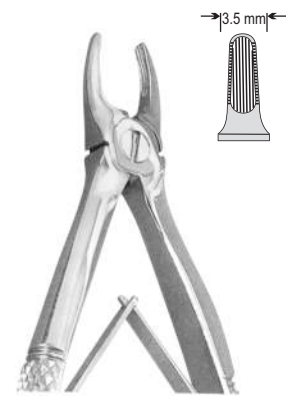
No. 22  
MD-01-094  
Lower Molars



No. 33  
MD-01-095  
Lower Roots



No. 51S  
MD-01-096  
Upper Roots



No. 137  
MD-01-097  
Upper Incisors

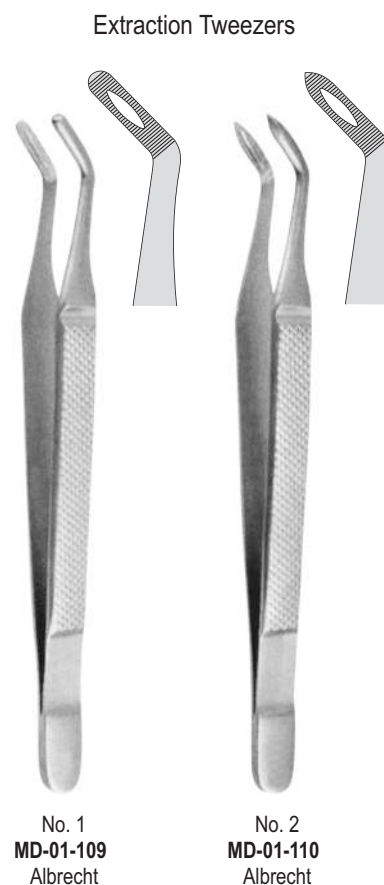
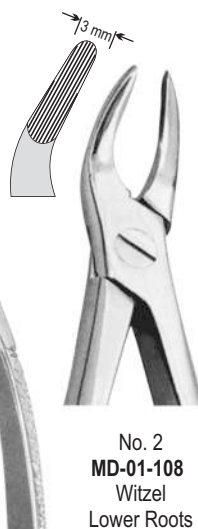
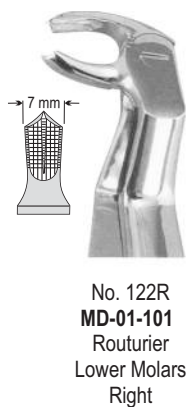


No. 7  
MD-01-098  
Upper Premolars



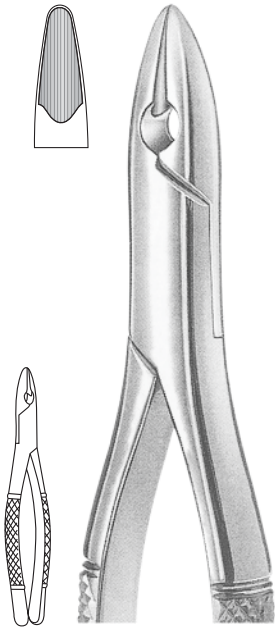
MD-01-099  
Set of 7 pieces

EXTRACTION FOCEPS

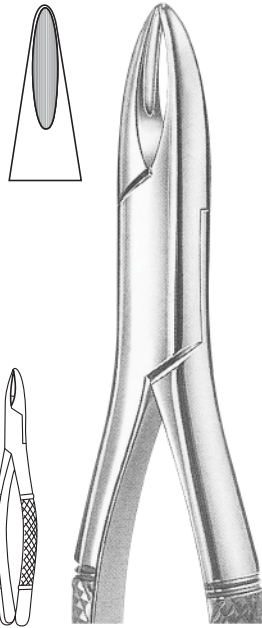




EXTRACTION FOCEPS "AMERICAN PATTERN"



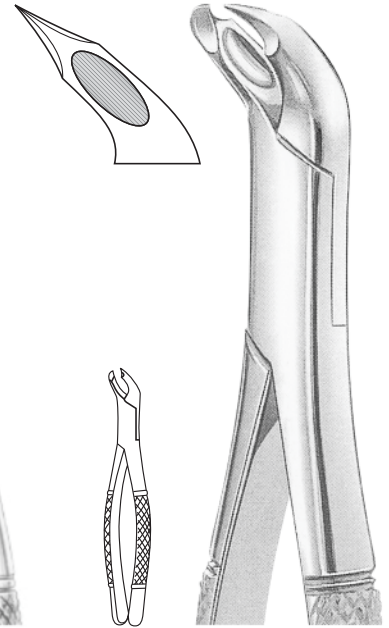
**MD-01-111**  
Upper incisors & cuspids



**MD-01-112**  
Upper incisors



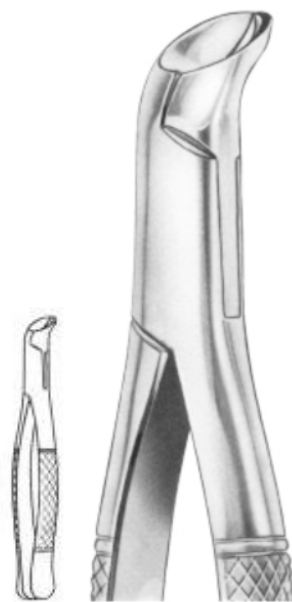
**MD-01-113**  
Upper & Lower Roots



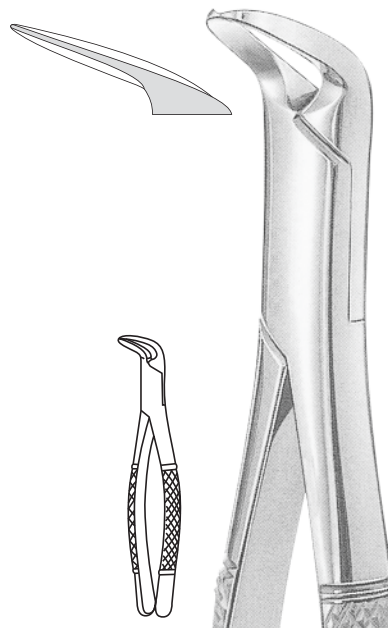
**No. 3FS  
MD-01-114**  
Lower molars



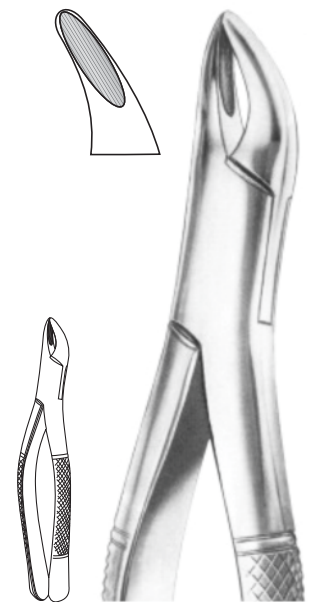
**No.4  
MD-01-115**  
Upper & Lower Premolars



**No. 5  
MD-01-116**  
Lower third molars



**No. 6  
MD-01-117**  
Splitting & Separating Forceps

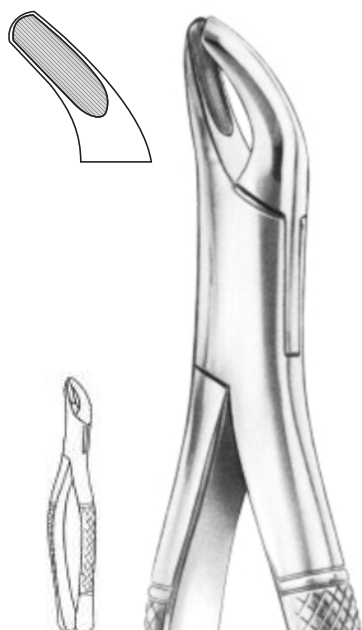


**No. 7  
MD-01-118**  
Upper Roots

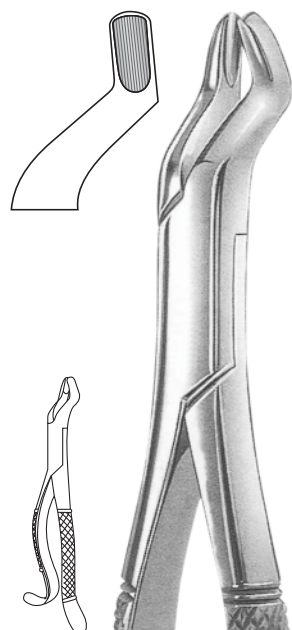




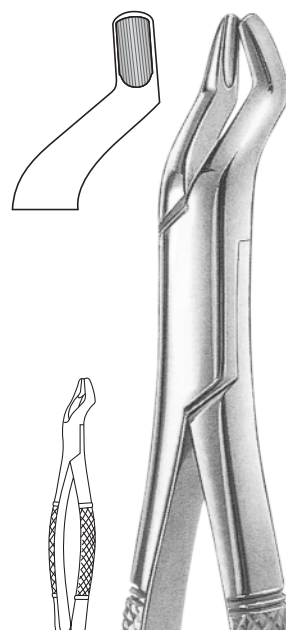
EXTRACTION FORCEPS "AMERICAN PATTERN"



No. 8  
**MD-01-119**  
Upper & Lower third molars



10 H  
**MD-01-120**  
Upper Molars, Hook Handle



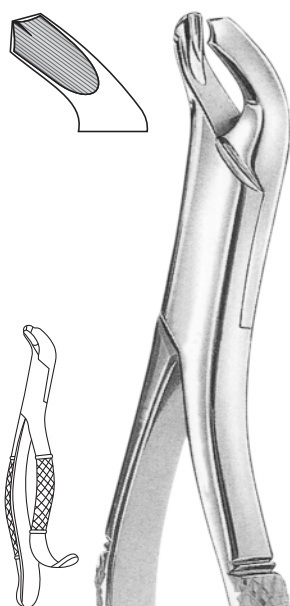
10 S  
**MD-01-121**  
Upper Molars



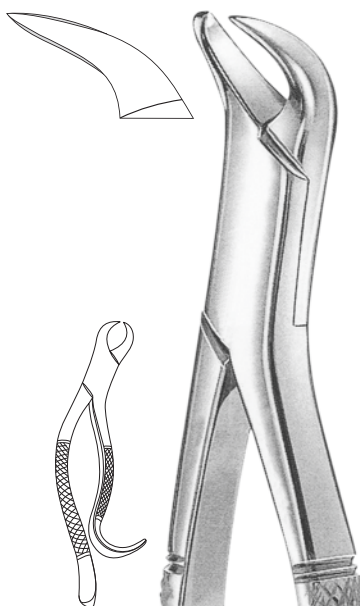
No. 13  
**MD-01-122**  
Upper Incisors



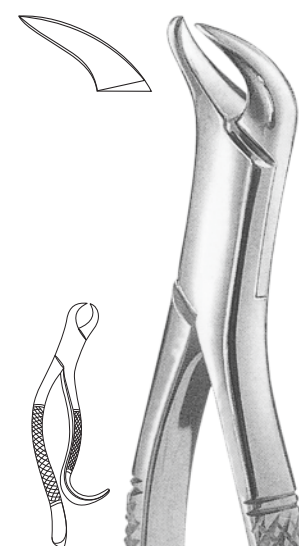
No. 14  
**MD-01-123**  
Lower Incisors



No. 15  
**MD-01-124**  
1st & 2nd Lower Molars



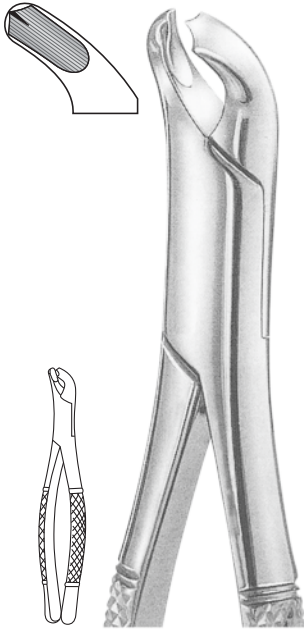
No. 16  
**MD-01-125**  
1st & 2nd Lower Molars



No. 16S  
**MD-01-126**  
Children, Lower Molars



## EXTRACTION FOCEPS "AMERICAN PATTERN"



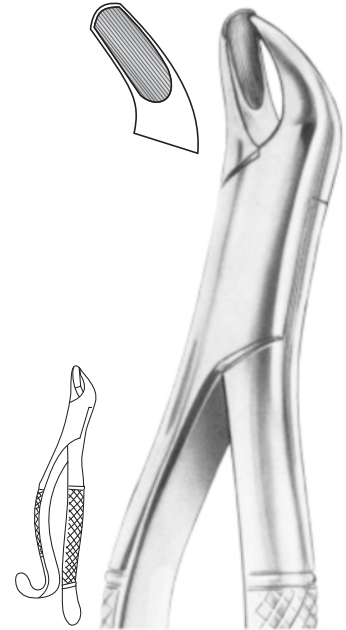
No. 17  
**MD-01-127**  
 Gold Plated  
 1st & 2nd Lower Molars



18L  
**MD-01-128**  
 1st & 2nd Upper Molars, left



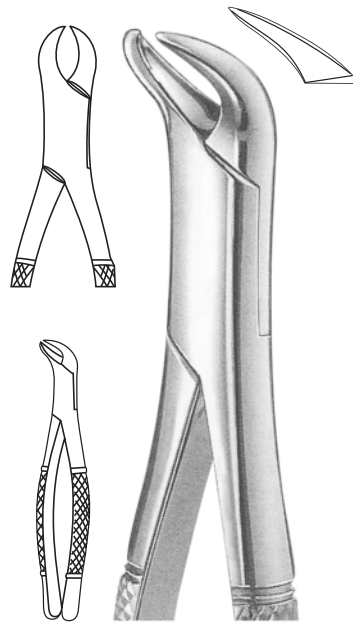
18R  
**MD-01-129**  
 1st & 2nd Upper Molars, right



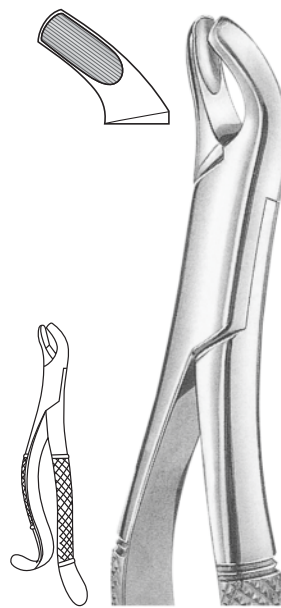
No. 20L  
**MD-01-130**  
 Upper Molars left



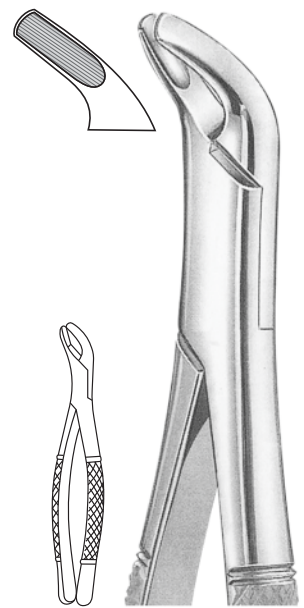
20R  
**MD-01-131**  
 Upper Molars right



No. 23  
**MD-01-132**  
 Lower Molars



No. 24  
**MD-01-133**  
 Upper Molars



No. 27  
**MD-01-134**  
 Upper Molars



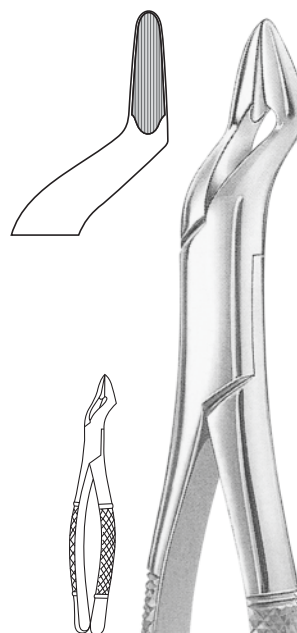
EXTRACTION FORCEPS "AMERICAN PATTERN"



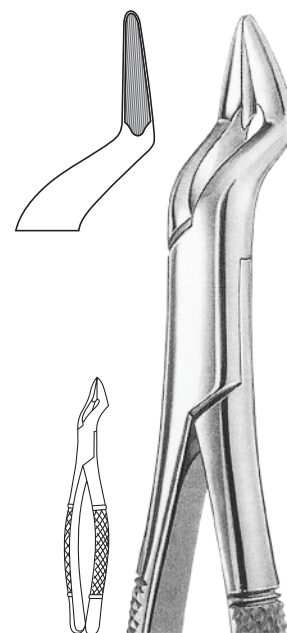
No. 29S  
MD-01-135  
Lower teeth children



No. 30S  
MD-01-136  
Upper teeth children



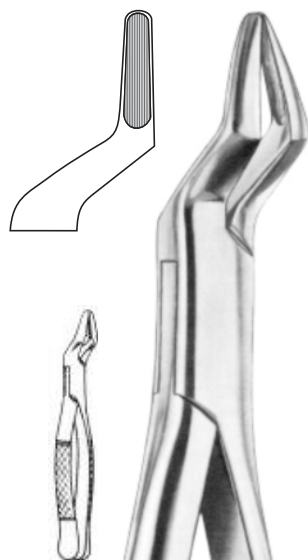
No. 32  
MD-01-137  
Upper Bicuspids



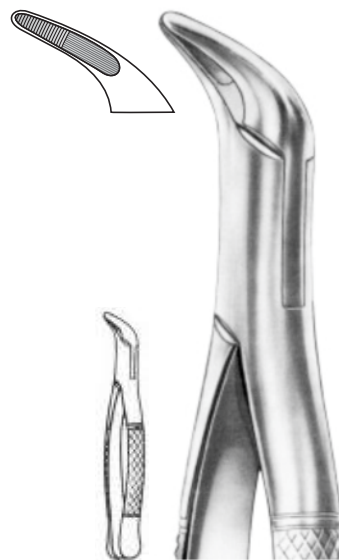
32A  
MD-01-138  
Upper Bicuspids & Roots



No. 34  
MD-01-139  
Lower Anteriors & Roots



No. 35  
MD-01-140  
Upper Roots



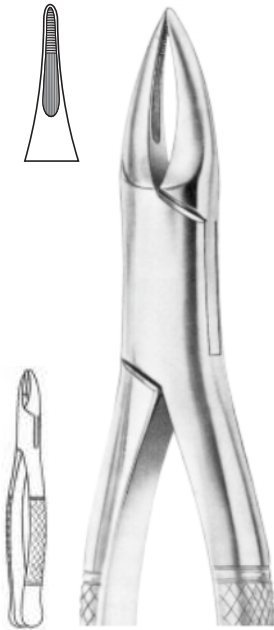
No. 36  
MD-01-141  
Lower Anteriors & Roots



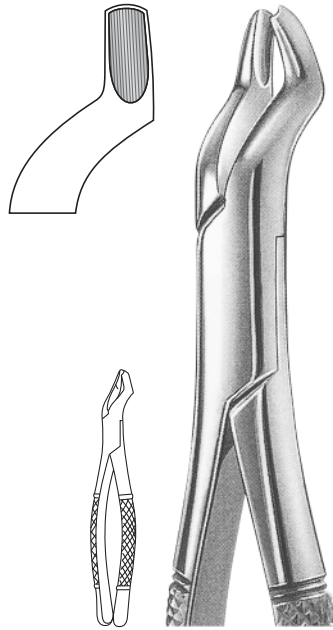
No. 37  
MD-01-142  
Lower Anteriors & Roots



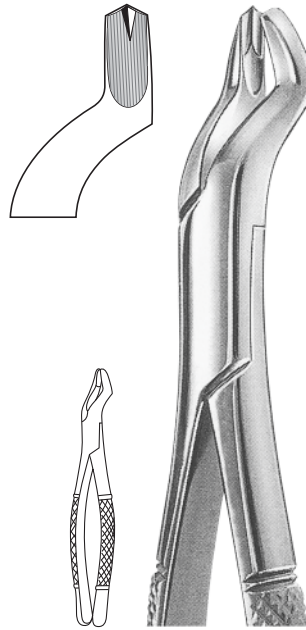
## EXTRACTION FOCEPS "AMERICAN PATTERN"



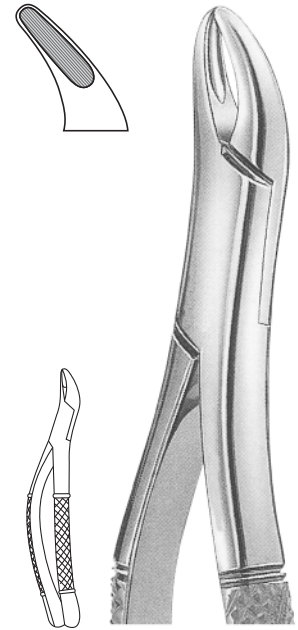
No. 38  
**MD-01-143**  
Upper Anteriors & Roots



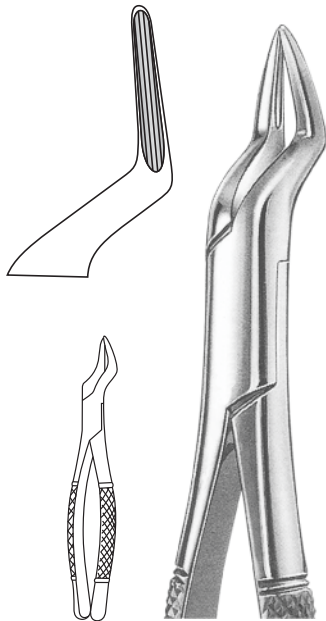
53L  
**MD-01-144**  
Gold Plated  
Upper Molars, left



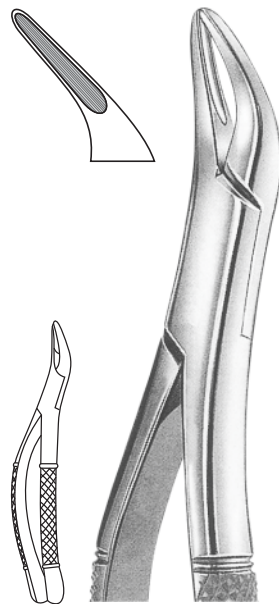
53R  
**MD-01-145**  
Gold Plated  
Upper Molars, right



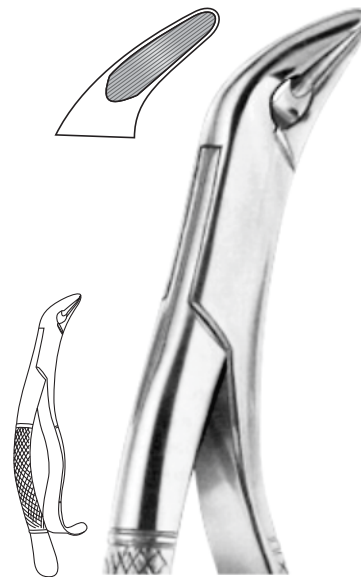
No. 62  
**MD-01-146**  
Upper & Lower Incisors



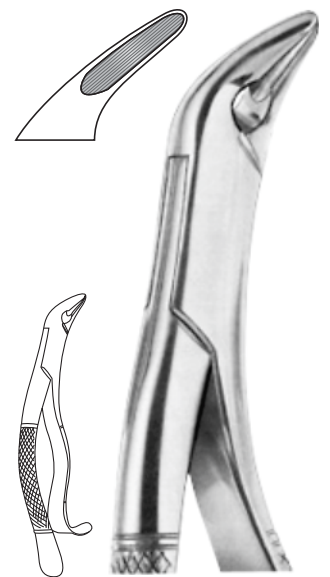
No. 65  
**MD-01-147**  
Gold Plated  
Upper Incisors, Roots & Fragments



No. 69  
**MD-01-148**  
Gold Plated  
Upper & Lower Fragments & Roots



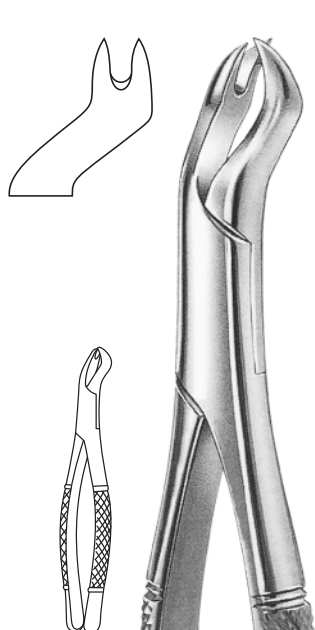
No. 85  
**MD-01-149**  
lower canines,  
premolars and molars



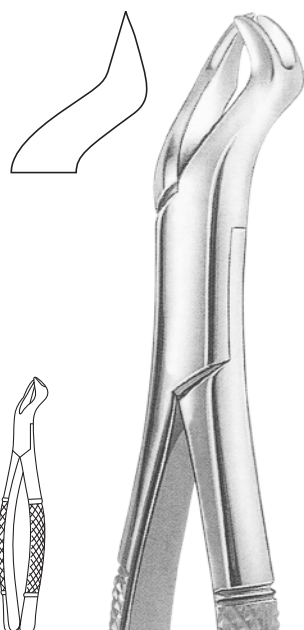
No. 85A  
**MD-01-150**  
lower canines,  
premolars and molars



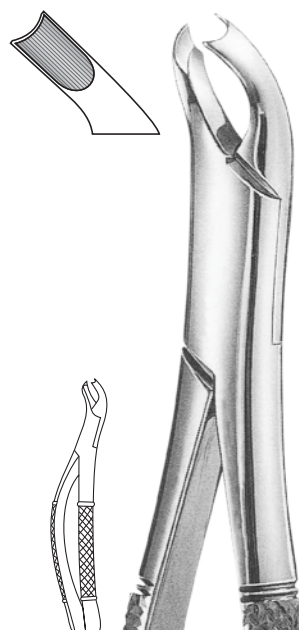
EXTRACTION FORCEPS "AMERICAN PATTERN"



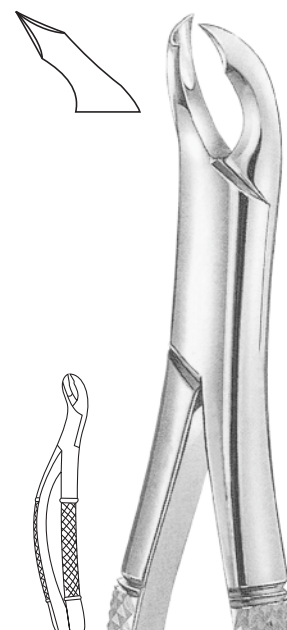
88L  
MD-01-151  
Upper Molars, left



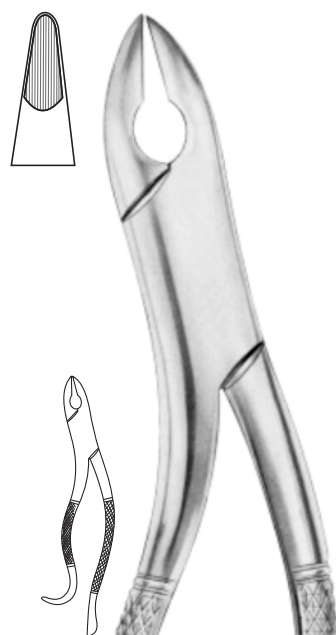
88R  
MD-01-152  
Upper Molars, right



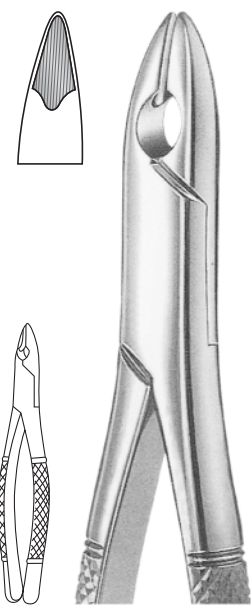
No. 89  
MD-01-153  
Upper Molars, right



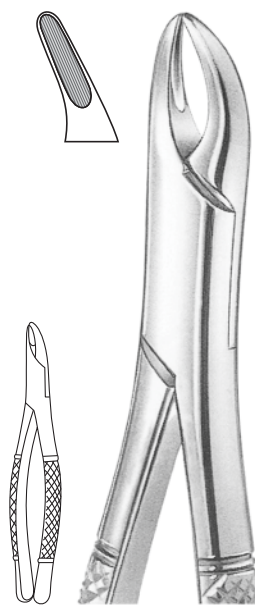
No. 90  
MD-01-154  
Upper Molars, left



Kells  
99A MD-01-155  
Upper Incisors, Canines, Premolars



Kells  
99C MD-01-156  
Upper Incisors & Bicuspid



Hull  
No. 101 MD-01-157  
Universal for Bicuspid & Deciduous



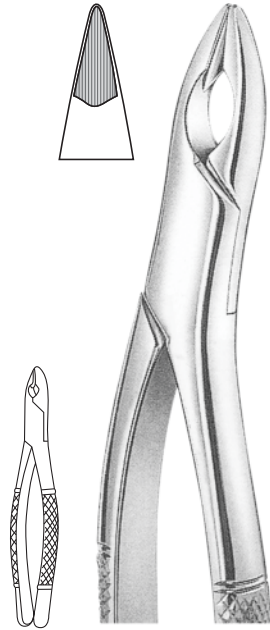
No. 103 MD-01-158  
lower incisors, premolars



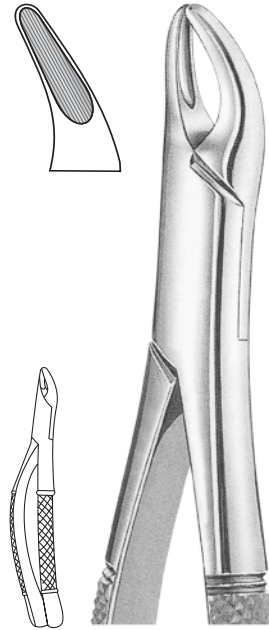
EXTRACTION FOCEPS "AMERICAN PATTERN"



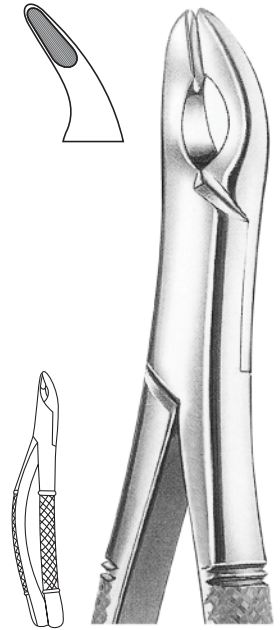
No. 104  
**MD-01-159**  
Upper third molars



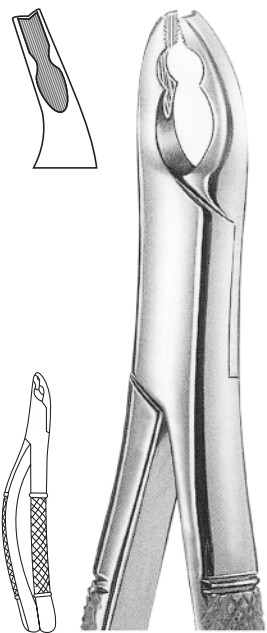
Nevius  
No. 110S **MD-01-160**  
Upper Bicuspids & Cuspids



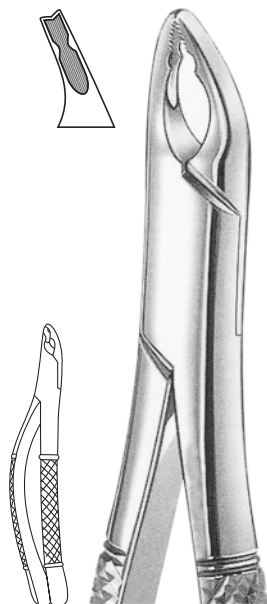
No. 150  
**MD-01-161**  
Upper Incisors, Bicuspids & Roots



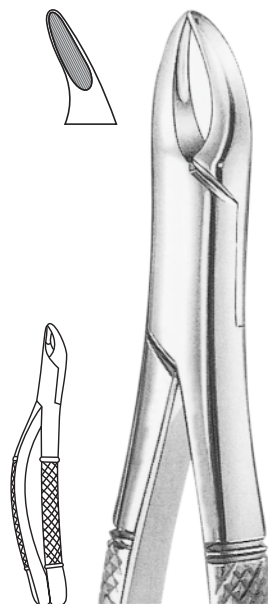
Cryer  
150A **MD-01-162**  
Upper Incisors, Cuspids & Bicuspids



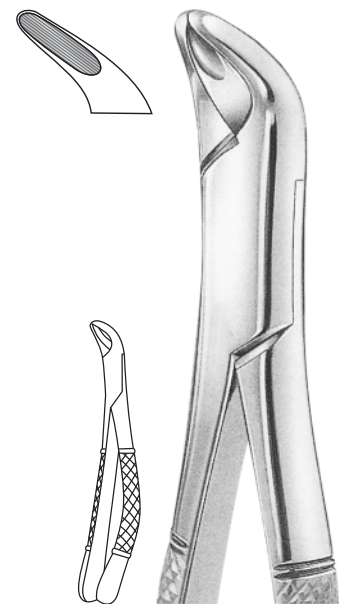
Cryer  
150 AS **MD-01-163**  
Upper Incisors, Cuspids  
serrated jaw



Cryer  
No. 150 XAS **MD-01-164**  
Children, Upper Incisors &  
Cuspids, serrated jaw



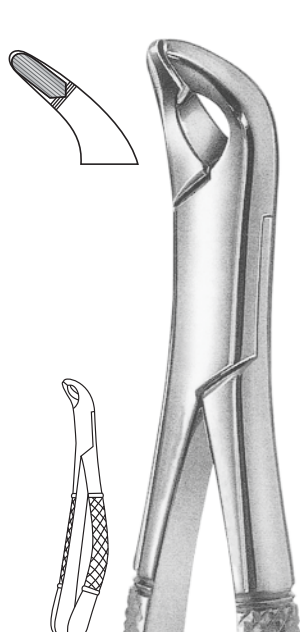
Cryer  
No. 150 S  
**MD-01-165**  
Children, Upper Incisors, Bicuspids & Roots



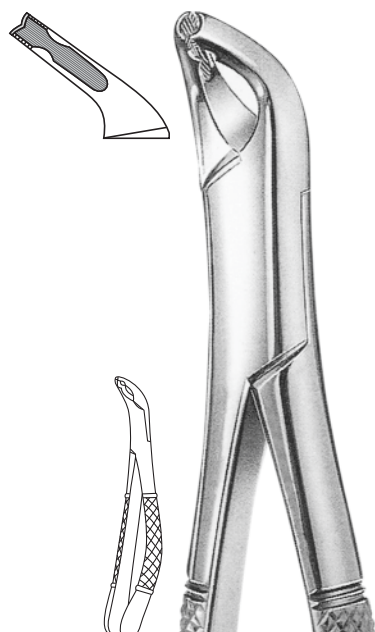
Cryer  
No. 151  
**MD-01-166**  
Lower Incisors, Bicuspids & Roots



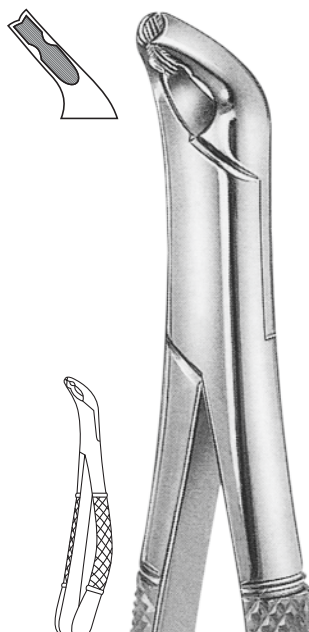
EXTRACTION FORCEPS "AMERICAN PATTERN"



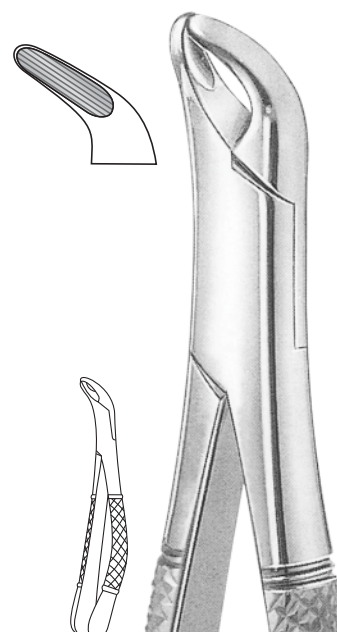
Cryer  
151 A  
**MD-01-167**  
Lower Incisors, Cuspids  
& Bicuspids



Cryer  
151 AS  
**MD-01-168**  
Lower Incisors & Cuspids, serrated jaw



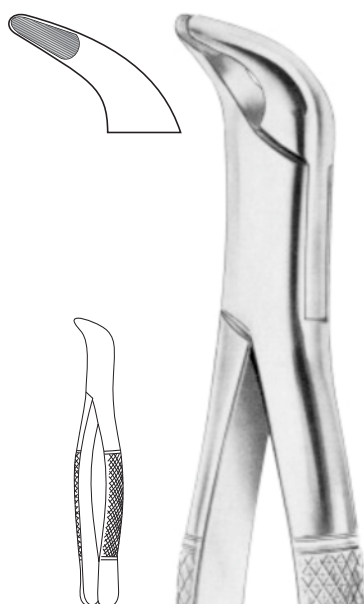
No. 151 XAS  
**MD-01-169**  
Children, Lower Incisors &  
Cuspids, serrated jaw



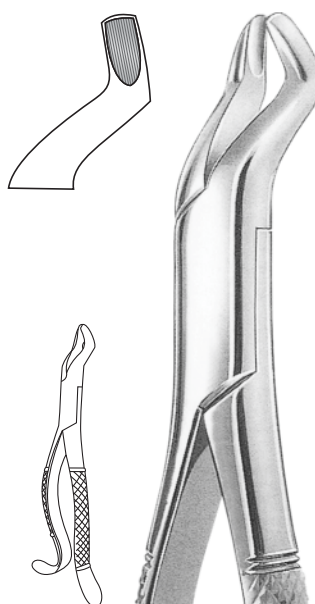
Cryer  
No. 151S  
**MD-01-170**  
Children, Lower incisors, Bicuspids & Roots



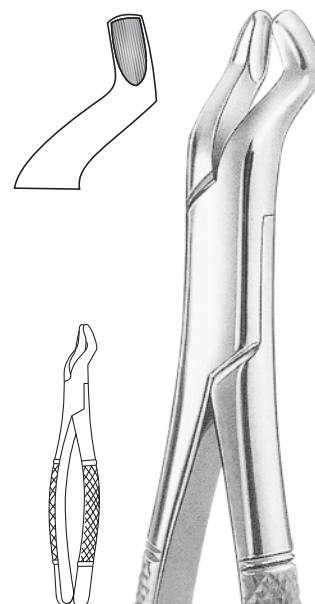
No. 201  
**MD-01-171**  
Upper Incisors, Canines, premolars



No. 203  
**MD-01-172**  
Lower Incisors & Roots



No. 210 H  
**MD-01-173**  
Upper Wisdoms, Hook Handle



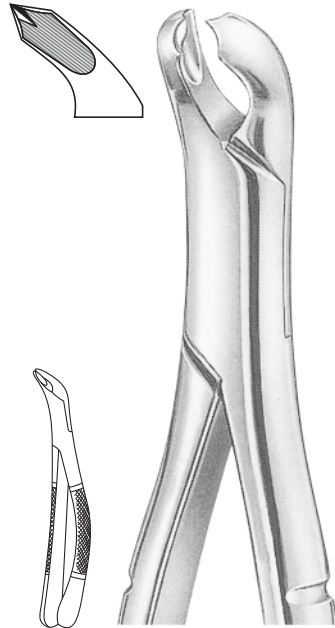
No. 210 S  
**MD-01-174**  
Upper Wisdoms



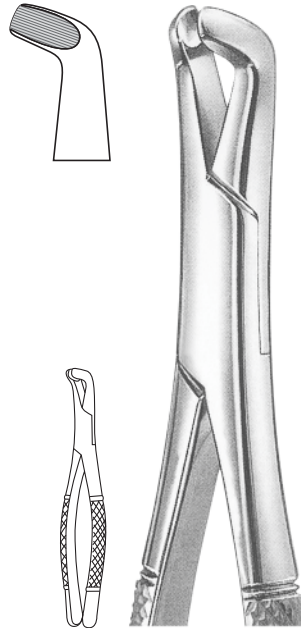
EXTRACTION FOCEPS "AMERICAN PATTERN"



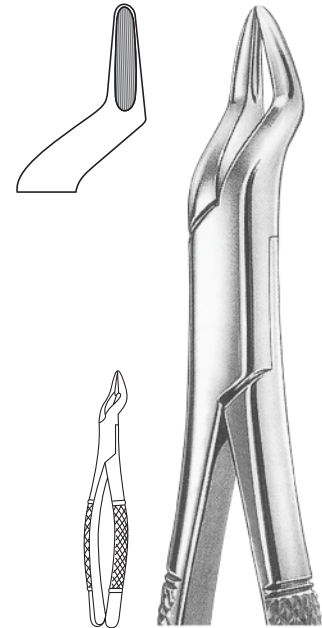
No. 213  
MD-01-175  
Upper Centrals & Canines



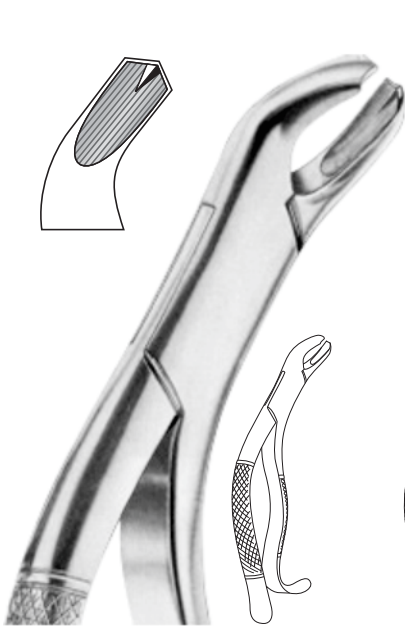
No. 217  
MD-01-176  
Lower Molars



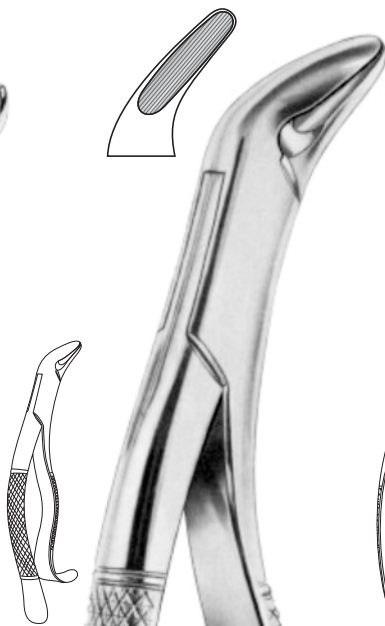
No. 222  
MD-01-177  
Lower Wisdoms



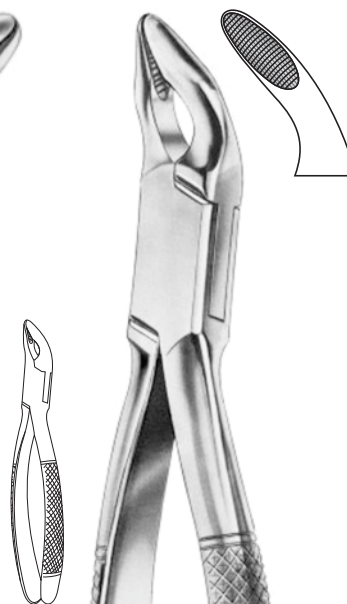
No. 286  
MD-01-178  
Upper Incisors, Bicuspid & Roots



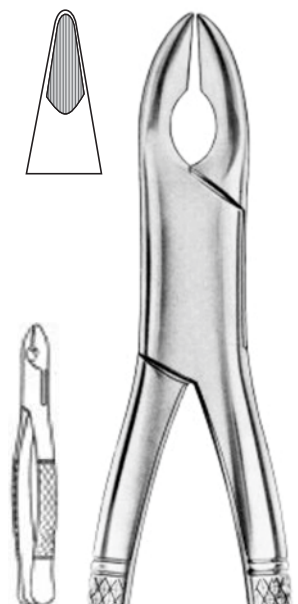
No. 286  
MD-01-179  
Swing lower molars



No. 288  
MD-01-180  
Lower Canines & Premolars



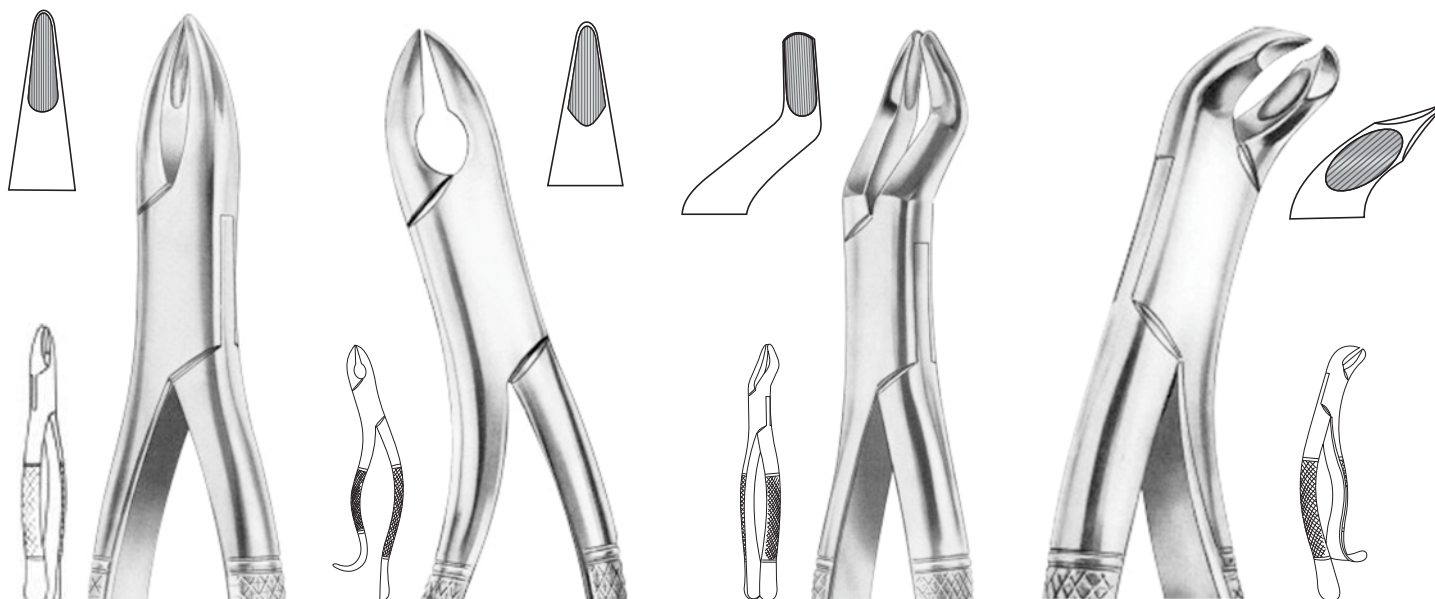
Cohen  
No. 310 MD-01-181  
Universal Forceps



Nevius  
No. 10S MD-01-182  
Upper Canines



EXTRACTION FORCEPS "AMERICAN PATTERN"

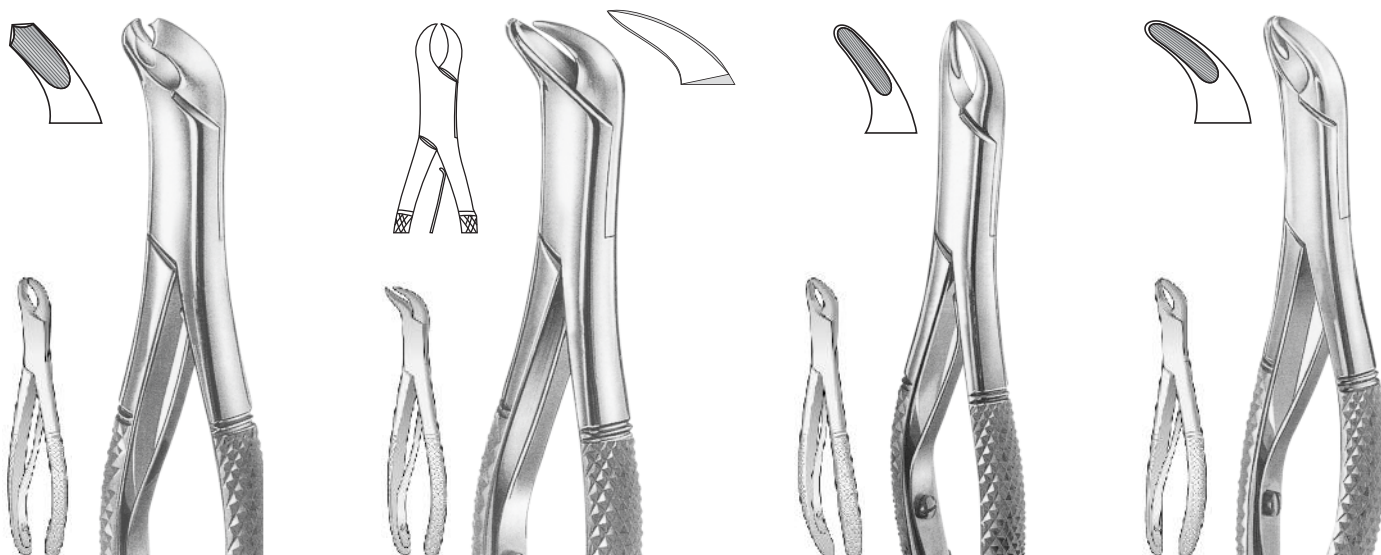


Henahan  
 No. 315A  
**MD-01-183**  
 Upper Incisors

Nevius  
 No. 325/10H  
**MD-01-184**  
 Upper Canines

Standard  
 No. 330  
**MD-01-185**  
 Upper Third Molars

Woodward  
 No. 335  
**MD-01-186**  
 Lower Molars



No. 17-K  
**MD-01-187**  
 children Lower Molars

No. 23-K  
**MD-01-188**  
 children Lower Molars

No. 150-K  
**MD-01-189**  
 Children, Upper Incisors,  
 Bicuspids & Roots

No. 151-K  
**MD-01-190**  
 Children, Lower Incisors,  
 Bicuspids & Roots

**MALLEABLE & DUCTILE**  
INSTRUMENTS

**02**

**Page 26-41**

**Pliers**

Pliers for Orthodontics & Prosthetics

Carbide Inserted Pliers

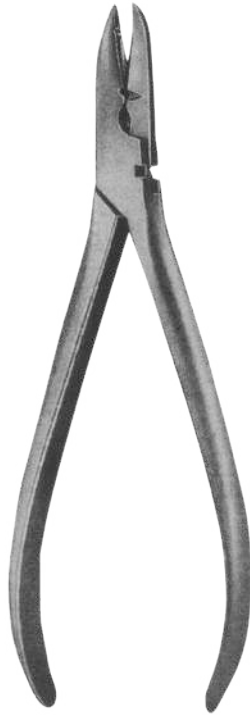
Orthodontics Pliers Stand

Bone Rongeurs

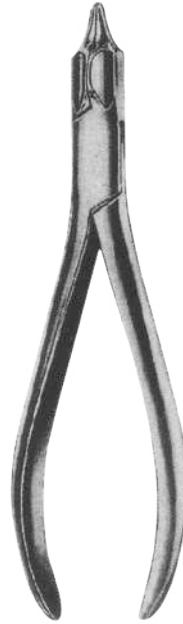




PLIERS FOR ORTHODONTICS & PROSTHETICS



**MD-02-001**  
Waldsachs  
15 cm



**MD-02-002**  
Universal  
16 cm



**MD-02-003**  
Nance  
13.5 cm



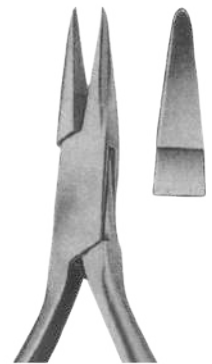
**MD-02-004**  
Aderer  
14.5 cm



**MD-02-005**  
Model Marburg  
Serrated Jaws  
14 cm



**MD-02-006**  
Model Marburg  
Smooth Jaws  
14 cm

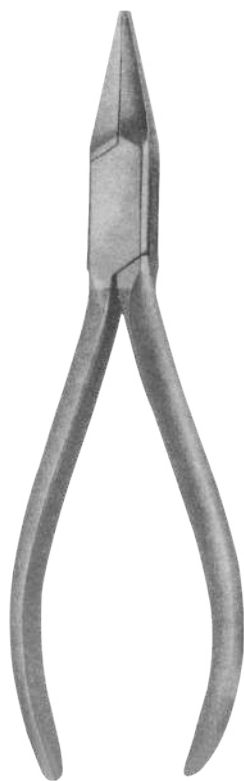


**MD-02-007**  
Model Marburg  
Smooth Jaws  
14 cm



**MD-02-008**  
Goslee  
Serrated Jaws  
14 cm

PLIERS FOR ORTHODONTICS & PROSTHETICS



**MD-02-009**  
 Flat Pliers  
 14 cm



**MD-02-010**  
 14 cm



**MD-02-011**  
 14 cm



**MD-02-012**  
 14 cm



**MD-02-013**  
 14 cm



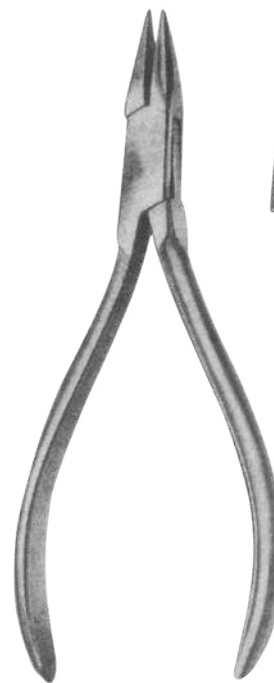
**MD-02-014**  
 14 cm



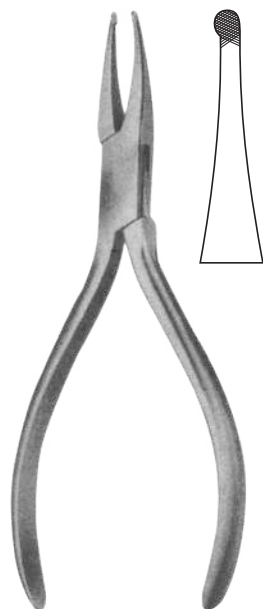
**MD-02-015**  
 14 cm



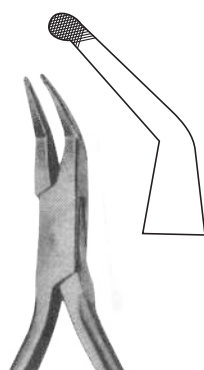
**MD-02-016**  
 14 cm



**MD-02-017**  
 Serrated Jaws  
 12 cm



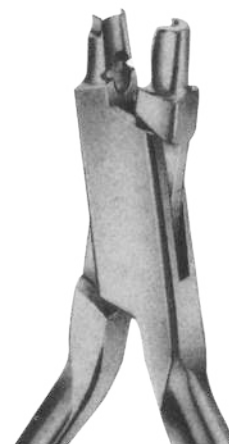
**MD-02-018**  
 How  
 14.5 cm



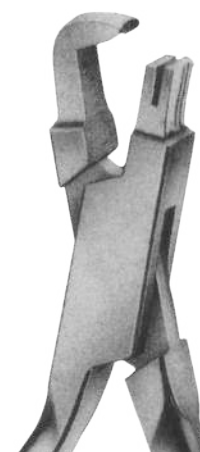
**MD-02-019**  
 How  
 14.5 cm



**MD-02-020**  
 How  
 14.5 cm



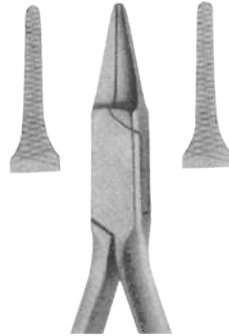
**MD-02-021**  
 Arrow Clasp Forming  
 12 cm



**MD-02-022**  
 Arrow Clasp Forming  
 12 cm



**MD-02-023**  
Peeso  
13.5 cm



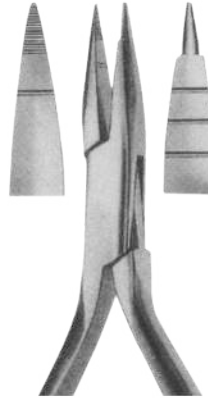
**MD-02-024**  
Peeso  
13.5 cm



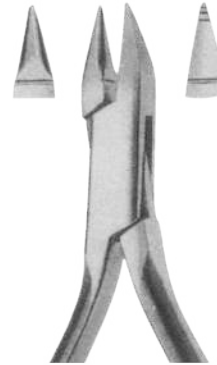
**MD-02-025**  
14 cm



**MD-02-026**  
Langenbeck  
14 cm



**MD-02-027**  
Jarabak  
14 cm



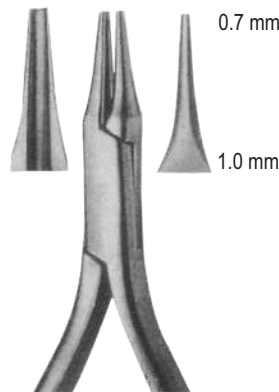
**MD-02-028**  
Bending Plier  
13 cm



**MD-02-029**  
Angle  
12.5 cm



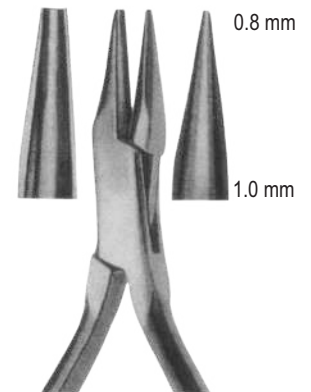
**MD-02-030**  
Andresen  
13 cm



**MD-02-031**  
Bending Plier  
13.5 cm



**MD-02-032**  
Schwarz  
13.5 cm



**MD-02-033**  
Fischer  
13 cm



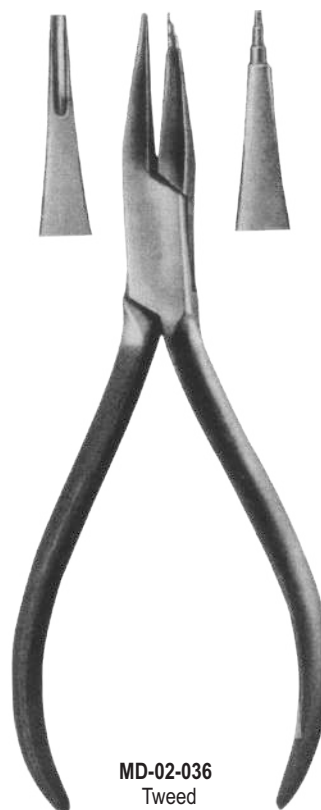
PLIERS FOR ORTHODONTICS & PROSTHETICS



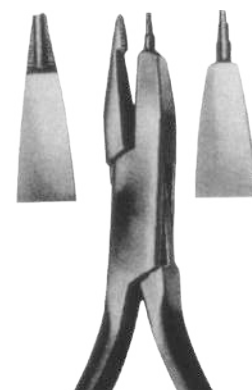
**MD-02-034**  
Aderer  
12 cm



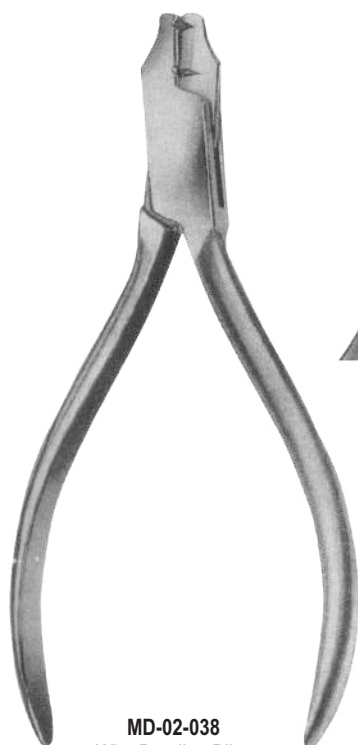
**MD-02-035**  
Aderer-Heavy  
12 cm



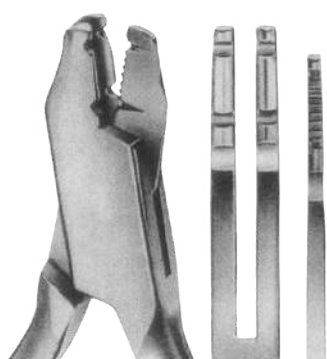
**MD-02-036**  
Tweed  
14.5 cm



**MD-02-037**  
O'brien  
13.5 cm



**MD-02-038**  
Wire Bending Pliers  
12.5 cm



**MD-02-039**  
Adams  
12.5 cm



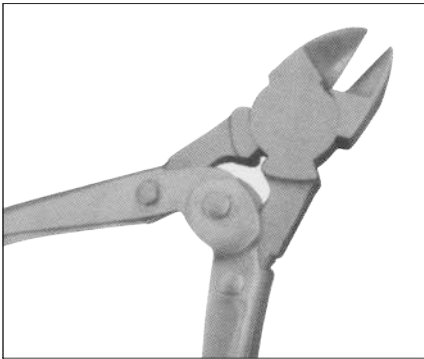
**MD-02-041**  
Young  
14 cm



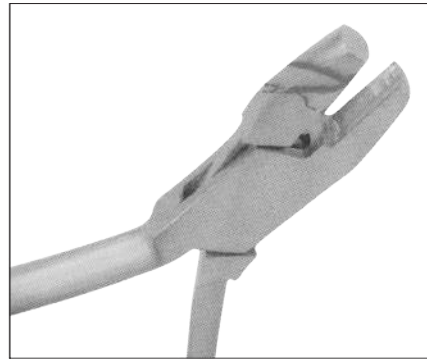
**MD-02-040**  
Frevert  
12.5 cm



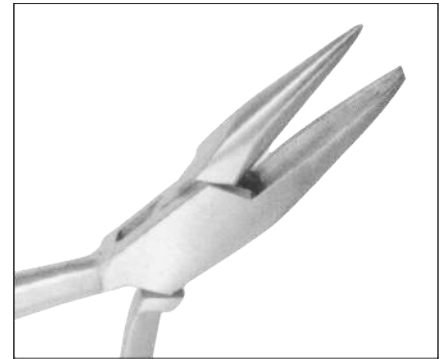
**MD-02-042**  
Clasp Forming  
14 cm



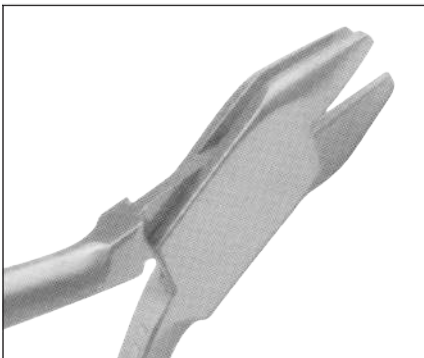
**MD-02-043**  
Hard Wire Cutter  
5 1/2" (14 cm)



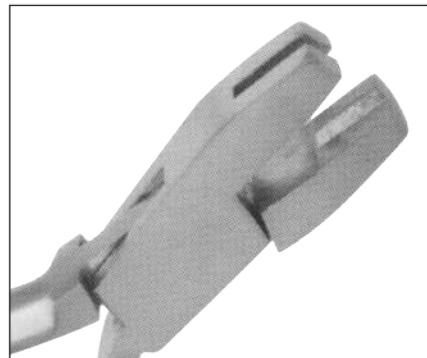
**MD-02-044**  
Arch Forming Plier  
5 1/2" (14 cm)



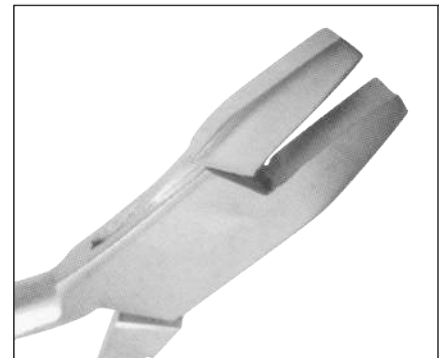
**MD-02-045**  
Medium Size Bending Plier  
5 1/2" (14 cm)



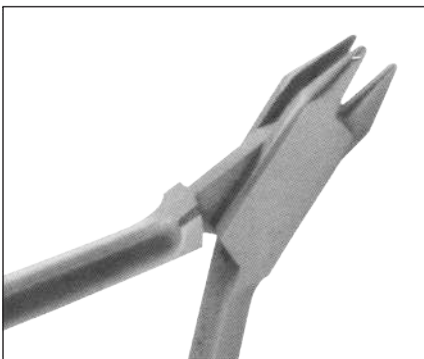
**MD-02-046**  
Aderer Pliers  
5 1/2" (14 cm)



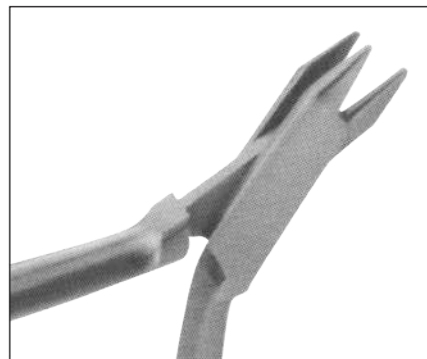
**MD-02-047**  
Wire Bending Plier  
5 1/2" (14 cm)



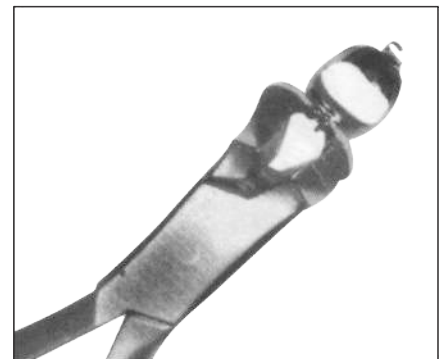
**MD-02-048**  
Round & Concave Pliers  
5 1/2" (14 cm)



**MD-02-049**  
Aderer Pliers  
with Narrow Standing Points,  
for Bending Wires up to  $\varnothing$  0.5 mm,  
Disinfectable, Sterilizable  
4 3/4" (12 cm)

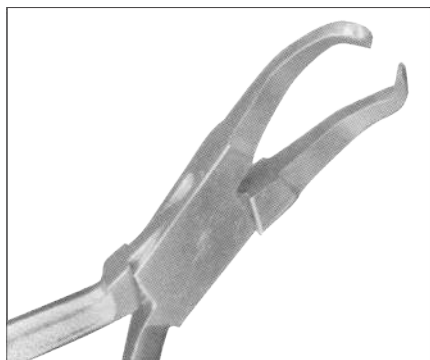


**MD-02-050**  
Aderer Pliers  
for Bending Wires up to  $\varnothing$  0.9 mm,  
Disinfectable, Sterilizable  
4 3/4" (12 cm)



**MD-02-051**  
Aderer Pliers  
Bending Plier for Lingual Cleat  
5 1/2" (14 cm)

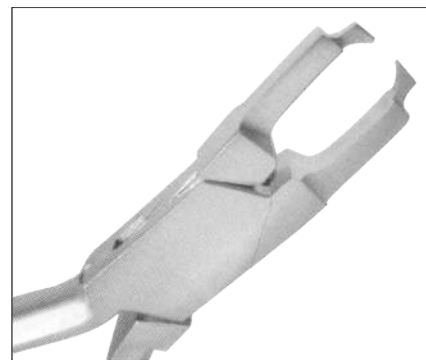
PLIERS FOR ORTHODONTICS & PROSTHETICS



**MD-02-052**  
 Bracket Removing Pliers  
 5 1/2" (14 cm)



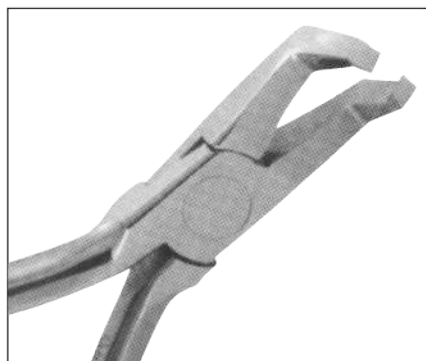
**MD-02-053**  
 Bracket Removing Pliers  
 5 1/2" (14 cm)



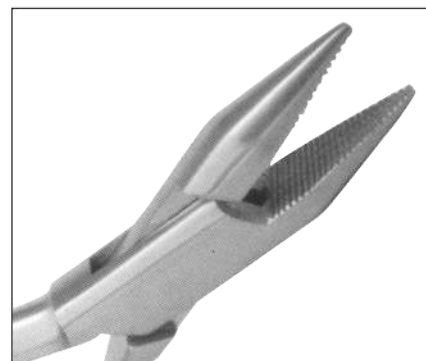
**MD-02-054**  
 Bracket Removing Pliers  
 5 1/2" (14 cm)



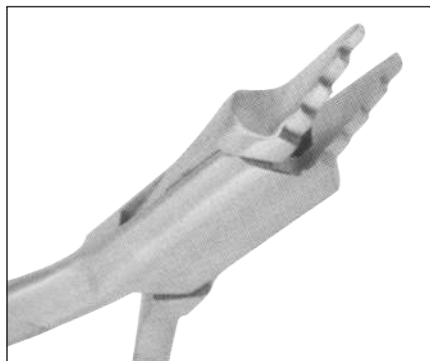
**MD-02-055**  
 Bracket Removing Pliers  
 5 1/2" (14 cm)



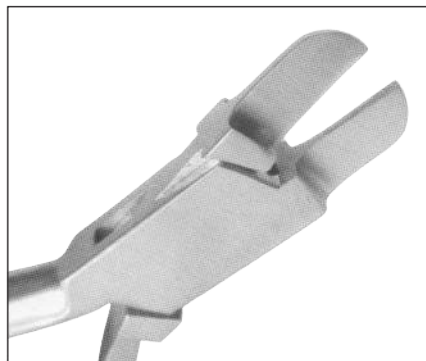
**MD-02-056**  
 Bracket Removing Pliers  
 5 1/2" (14 cm)



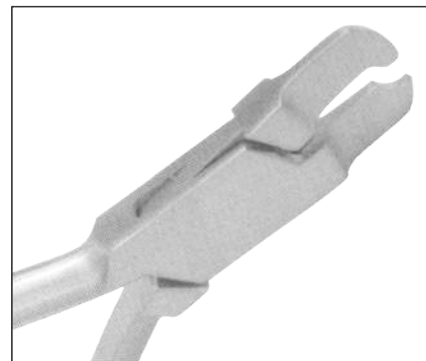
**MD-02-057**  
 Flat Pliers  
 5 1/2" (14 cm)



**MD-02-058**  
 Nance Closing Loop Pliers  
 5 1/2" (14 cm)

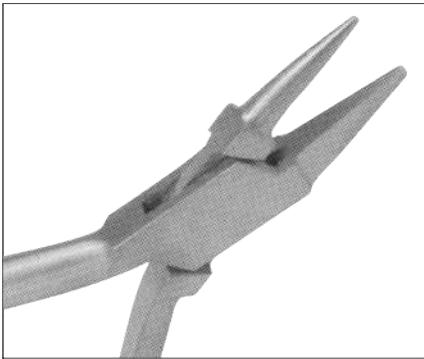


**MD-02-059**  
 Angle Banding Pliers  
 5 1/2" (14 cm)

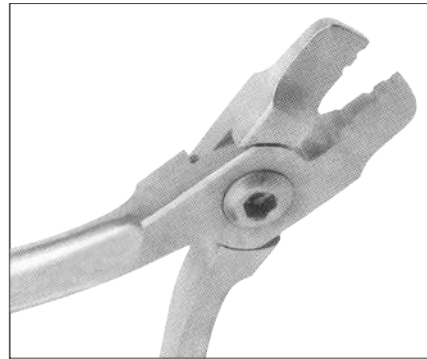


**MD-02-060**  
 Crown Crimping Pliers  
 5 1/2" (14 cm)

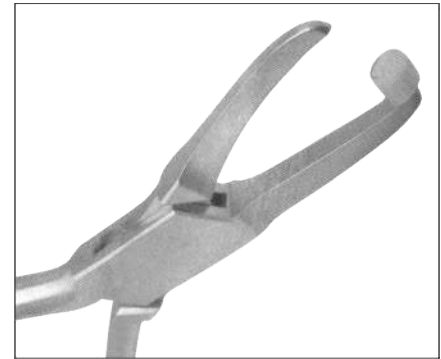




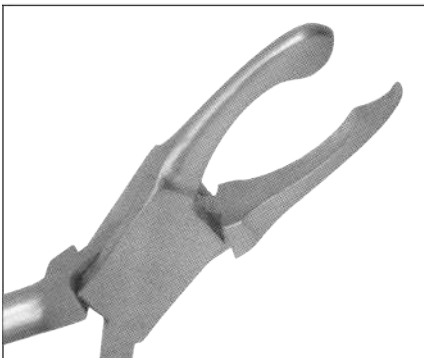
**MD-02-061**  
Round & Flat Plier  
5 1/2" (14 cm)



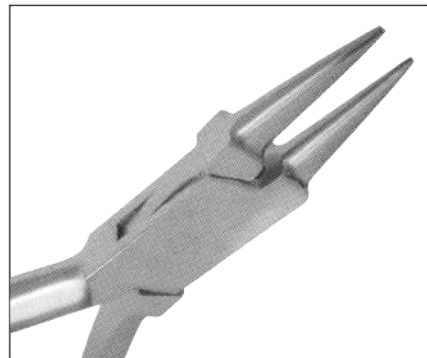
**MD-02-062**  
Tweed Angle Arch Bending  
5 1/2" (14 cm)



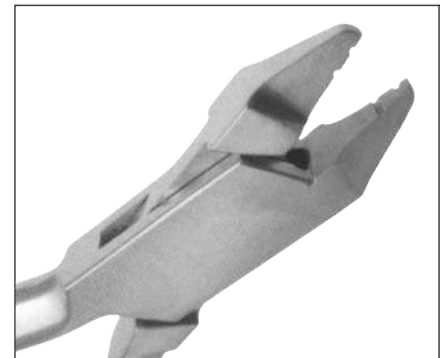
**MD-02-063**  
Bend Removing Pliers  
5 1/2" (14 cm)



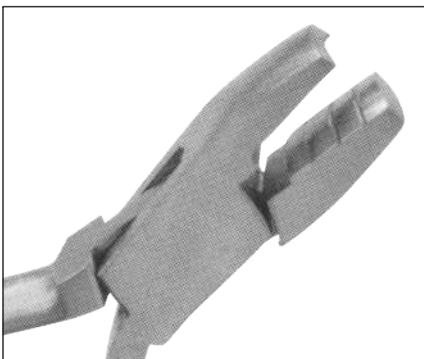
**MD-02-064**  
Johnson Contouring Pliers  
5 1/2" (14 cm)



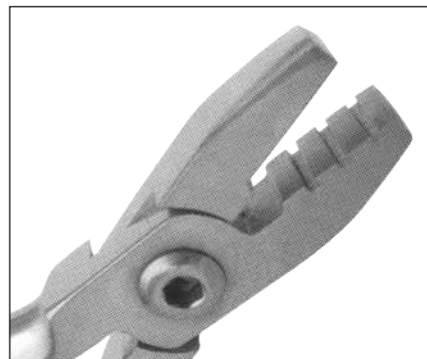
**MD-02-065**  
Round Nose Pliers  
5 1/2" (14 cm)



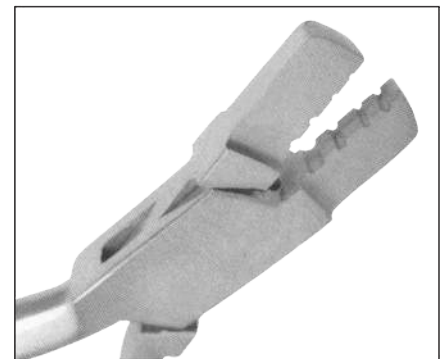
**MD-02-066**  
Tweed Angle Arch Bending  
5 1/2" (14 cm)



**MD-02-067**  
De La Rosa Pliers  
5 1/2" (14 cm)

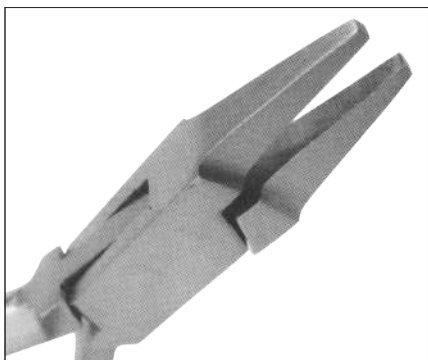


**MD-02-068**  
Arch Forming Pliers  
5 1/2" (14 cm)

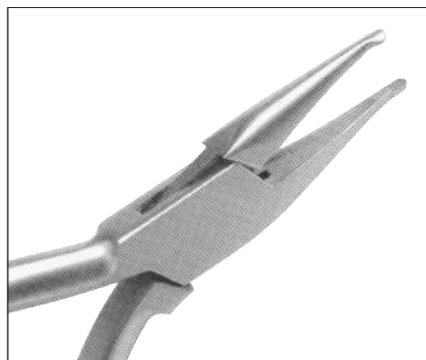


**MD-02-069**  
Tweed Angle Arch Bending  
5 1/2" (14 cm)

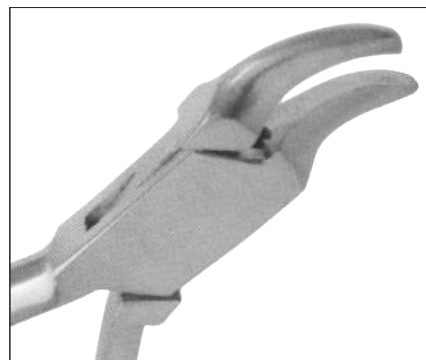
PLIERS FOR ORTHODONTICS & PROSTHETICS



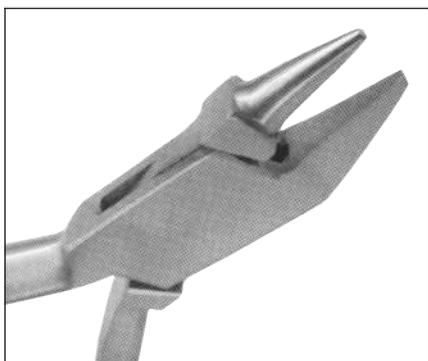
**MD-02-070**  
 Flat Nose Pliers  
 5 1/2" (14 cm)



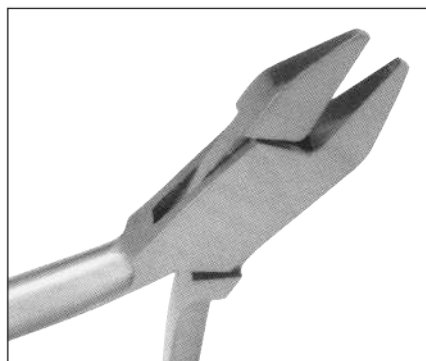
**MD-02-071**  
 How Pliers  
 5 1/2" (14 cm)



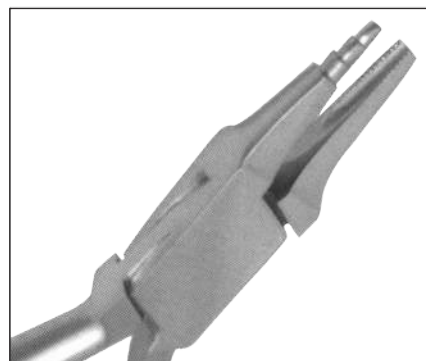
**MD-02-072**  
 Gordon - Contouring  
 5 1/2" (14 cm)



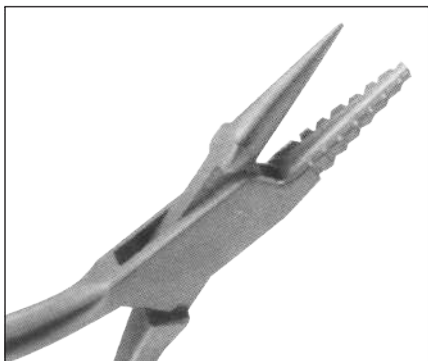
**MD-02-073**  
 Adams Pliers  
 5 1/2" (14 cm)



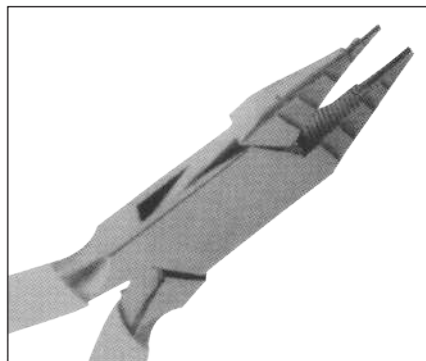
**MD-02-074**  
 Adams Pliers  
 5 1/2" (14 cm)



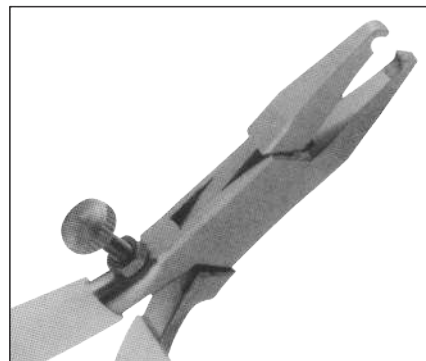
**MD-02-075**  
 Tweed Pliers  
 5 1/2" (14 cm)



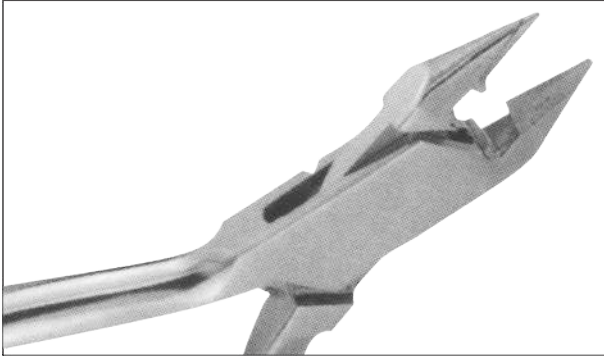
**MD-02-076**  
 Bending Pliers  
 Medium Fine, with Graduation  
 for Wire up  $\varnothing$  1.0 mm  
 5 1/2" (14 cm)



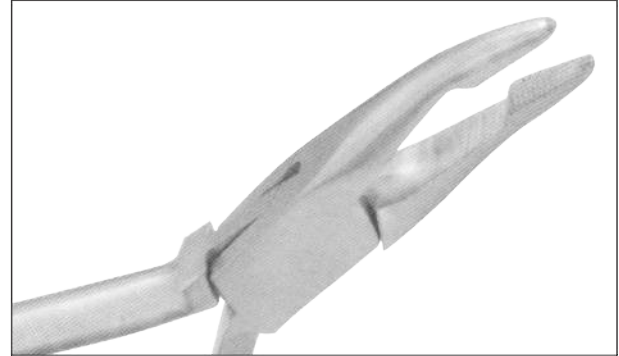
**MD-02-077**  
 Special Pliers  
 Max .022" x .028"  
 5 1/2" (14 cm)



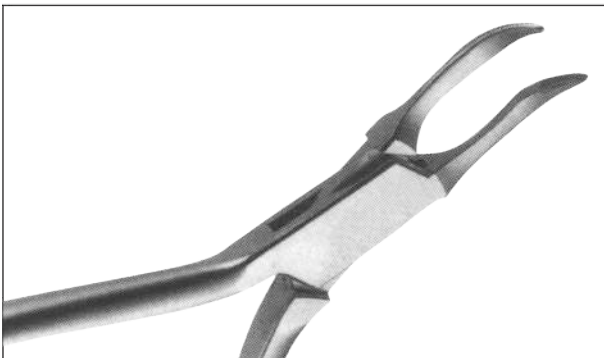
**MD-02-078**  
 Pliers for Operating  
 the Mobil-Stop  
 5 1/2" (14 cm)



**MD-02-079**  
Light Wire Plier for Wires  
up to Ø 0.60 mm  
with Cutter Begg  
4 3/4" (12 cm)



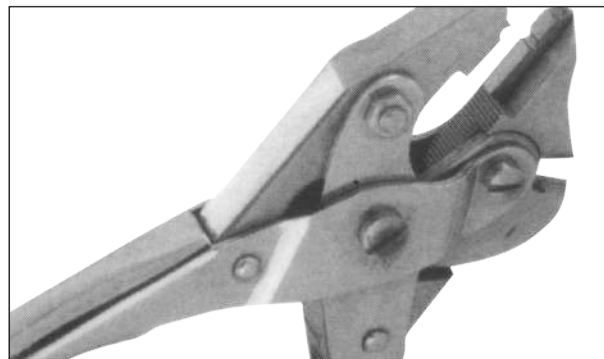
**MD-02-080**  
Weingart Universal Pliers  
5 1/2" (14 cm)



**MD-02-081**  
Weingart Ultra Lightwire Pliers  
5 1/2" (14 cm)

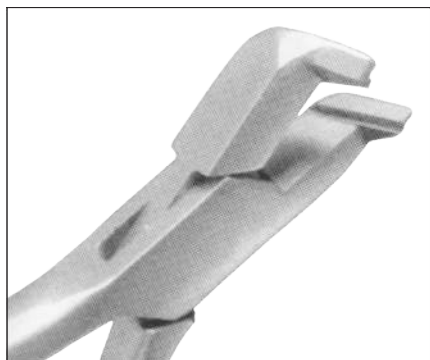


**MD-02-082**  
Weingart Universal Lightwire Pliers  
5 1/2" (14 cm)



**MD-02-083**  
Universal Facebow Pliers  
6 1/2" (16.5 cm)

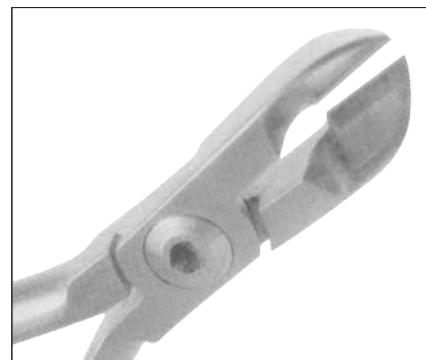
CARBIDE INSERTED PLIERS



**MD-02-084**  
 Distel Cutter Light Weight  
 5 1/2" (14 cm)



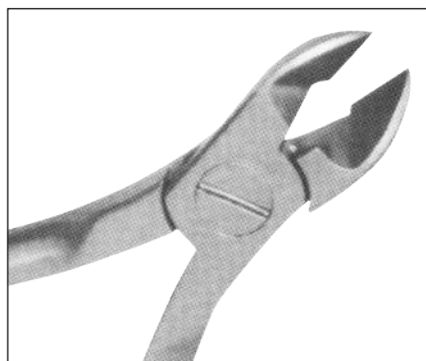
**MD-02-085**  
 Distel Cutter Medium  
 5 1/2" (14 cm)



**MD-02-086**  
 Ligature Pin Cutter  
 5 1/2" (14 cm)



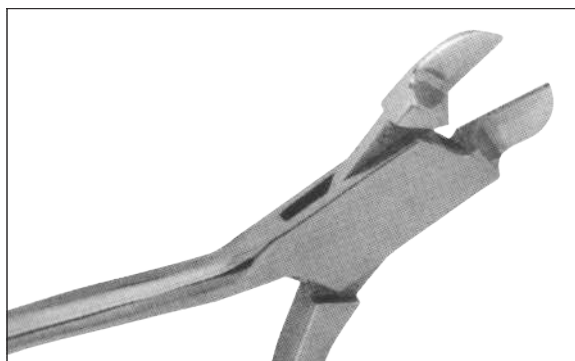
**MD-02-087**  
 Hard Wire Cutter  
 5 1/2" (14 cm)



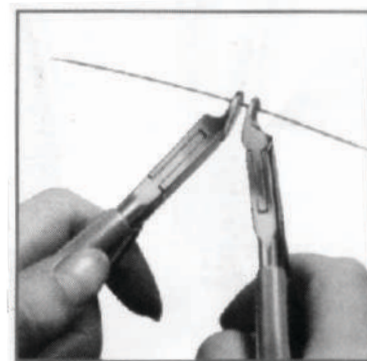
**MD-02-088**  
 Hard Wire Cutter  
 5 1/2" (14 cm)



**MD-02-089**  
 Bracket Removing Pliers  
 5 1/2" (14 cm)



**MD-02-090**  
 Arch Torquing and Bending Pliers  
 for Wires up to  $\varnothing$ 0.60 mm  
 Allow to User a Pair  
 4 3/4" (12 cm)



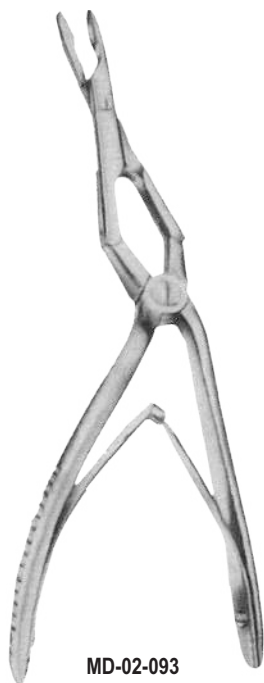


MD-02-091  
Pliers Stand

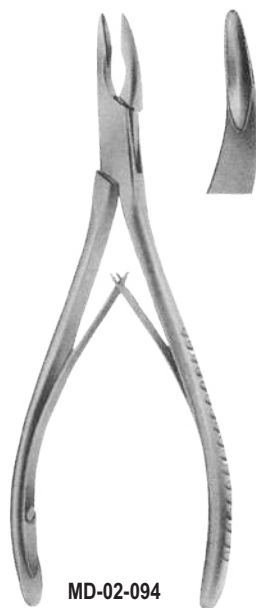
BONE RONGEURS



**MD-02-092**  
 Beyer  
 150 mm (6")  
 5 mm Bite



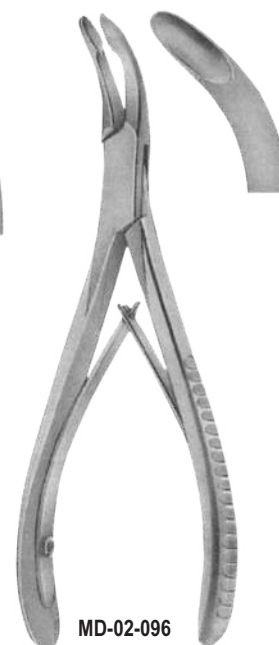
**MD-02-093**  
 Jansen-Middleton  
 Septum Forceps  
 200 mm (8") Spoon Shaped  
 4 mm Bite



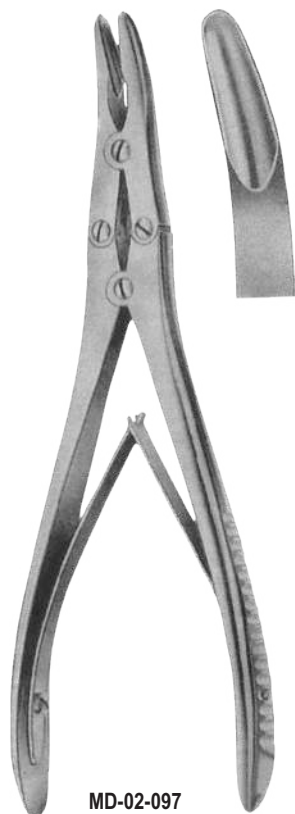
**MD-02-094**  
 Cairns  
 140 mm (5.1/2")  
 4 mm Bite



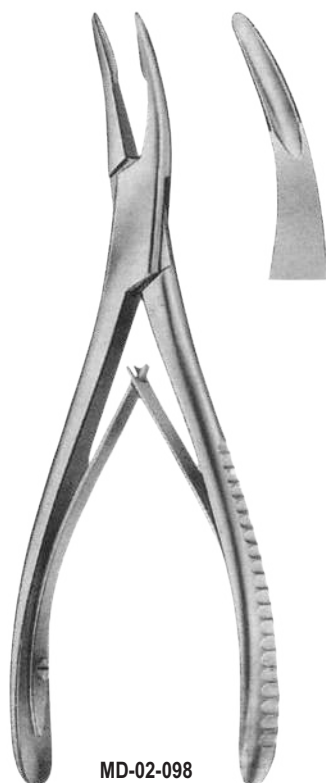
**MD-02-095**  
 Cairns  
 140 mm (5.1/2")  
 4 mm Bite



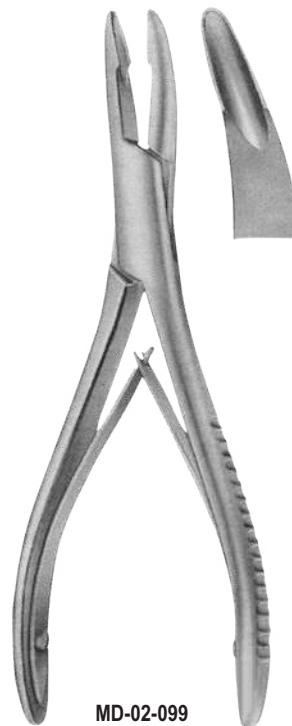
**MD-02-096**  
 Luer  
 155 mm (6")



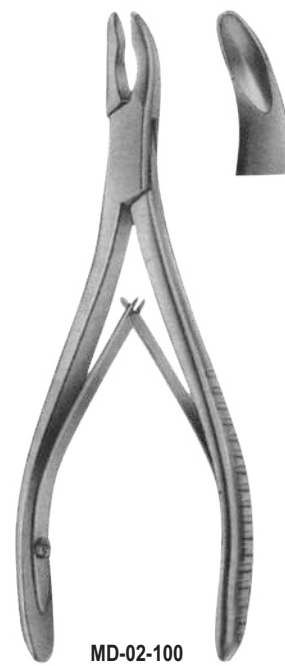
**MD-02-097**  
 Ruskin  
 190 mm (7.1/2")  
 6 mm Bite



**MD-02-098**  
 Hartmann  
 180 mm (7")



**MD-02-099**  
 Mead  
 165 mm (6.1/2")



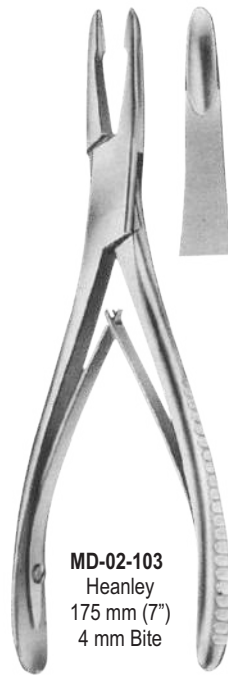
**MD-02-100**  
 Jansen  
 150 mm (6")



**MD-02-101**  
Trotter  
200 mm (8")  
10 mm Bite



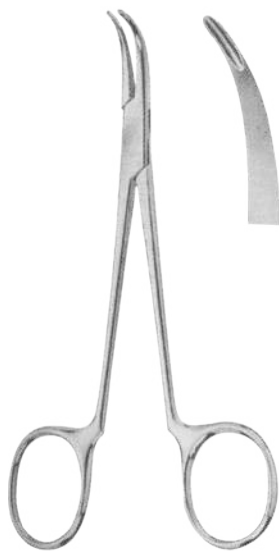
**MD-02-102**  
Synovectomy  
Rongeur  
175 mm (7")



**MD-02-103**  
Heanley  
175 mm (7")  
4 mm Bite



**MD-02-104**  
Pennybacker  
200 mm (8")  
4 mm Bite



**MD-02-105**  
Synovectomy Rongeur  
130 mm (5.1/8")  
Jaw Width 2 mm



**MD-02-106**  
Northfield  
200 mm (8")  
10 mm Bite

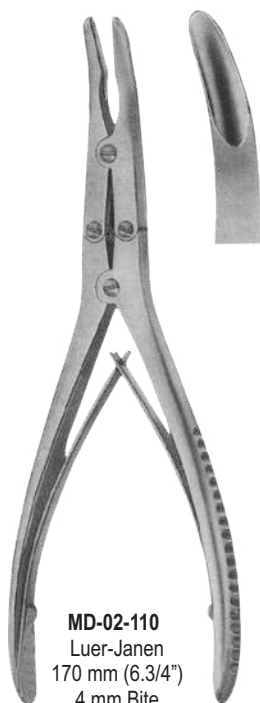


**MD-02-107**  
Wilms  
200 mm (8")  
4 mm Bite



Leksell  
**MD-02-108**  
240 mm (9.1/2")  
6 mm Bite  
**MD-02-109**  
240 mm (9.1/2")  
8 mm Bite

BONE RONGEURS



**MD-02-110**  
 Luer-Janen  
 170 mm (6.3/4")  
 4 mm Bite



**MD-02-111**  
 Beyer  
 180 mm (7")



**MD-02-112**  
 Beyer  
 200 mm (8")



**MD-02-113**  
 Killearn  
 197 mm (7.3/4")  
 3 mm Bite



**MD-02-114**  
 Zaufal-Jansen  
 240 mm (9.1/2")



**MD-02-115**  
 Echlin  
 240 mm (9.1/2")



**MD-02-116**  
 Northfield  
 225 mm (9") 10 mm Bite





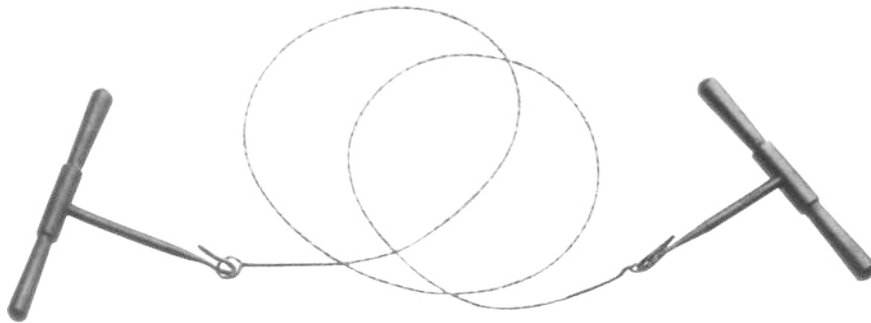
**MD-02-117**  
Sargent (Van Havre)  
220 mm (8.3/4")  
10 mm Bite



**MD-02-118**  
Olivecrona  
230 mm (9")  
6 mm Bite



**MD-02-119**  
Stille-Ruskin  
240 mm (9.1/2")  
6 mm Bite



**MD-02-120**  
Gigli Saw With Handle  
500 mm (20")



**MD-02-121**  
Rudor Edwards Costotome  
230 mm (9")

**MALLEABLE & DUCTILE**  
INSTRUMENTS

**03**

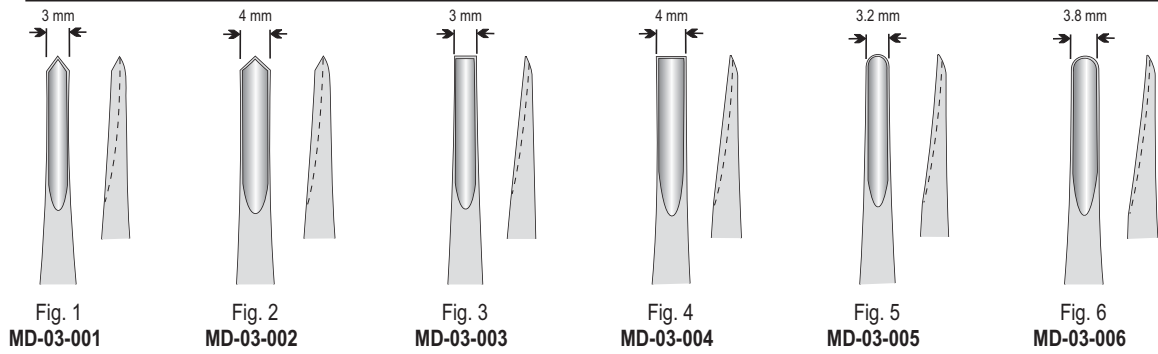
**Page 42-49**

**Elevators**

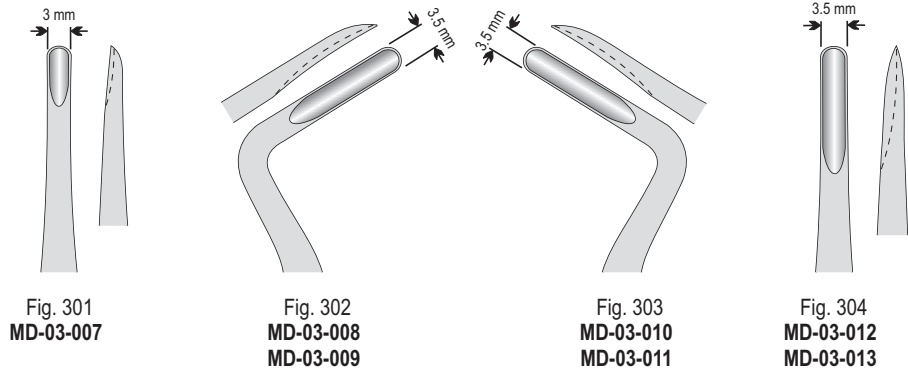
Root Elevators  
Syndesmotomes



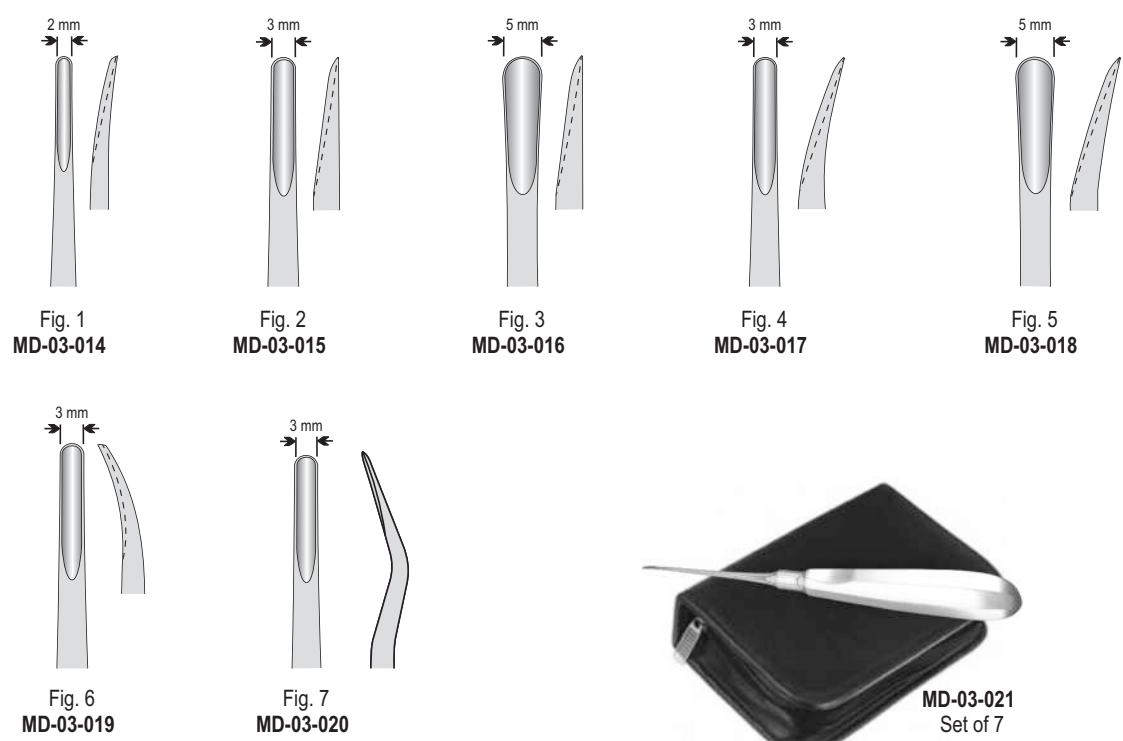
### Bein



### Apical



### Luxators



ROOT ELEVATORS



11  
**MD-03-022**  
 Miller-Apexo

12  
**MD-03-023**  
 Miller-Apexo

13  
**MD-03-024**  
 Miller-Apexo

14  
**MD-03-025**

15  
**MD-03-026**

22  
**MD-03-027**  
 Curtis

23  
**MD-03-028**  
 Curtis

Fig. 10  
**MD-03-030**  
 Seldin

Fig. 1R  
**MD-03-031**  
 Seldin

Fig. 4L  
**MD-03-032**  
 Seldin

Fig. 4R  
**MD-03-033**  
 Seldin

Fig. 11  
**MD-03-034**  
 Stout

Fig. 11A  
**MD-03-035**  
 Stout

Fig. 44C  
**MD-03-036**  
 Stout

Fig. 10  
**MD-03-029**  
 Miller-Apexo

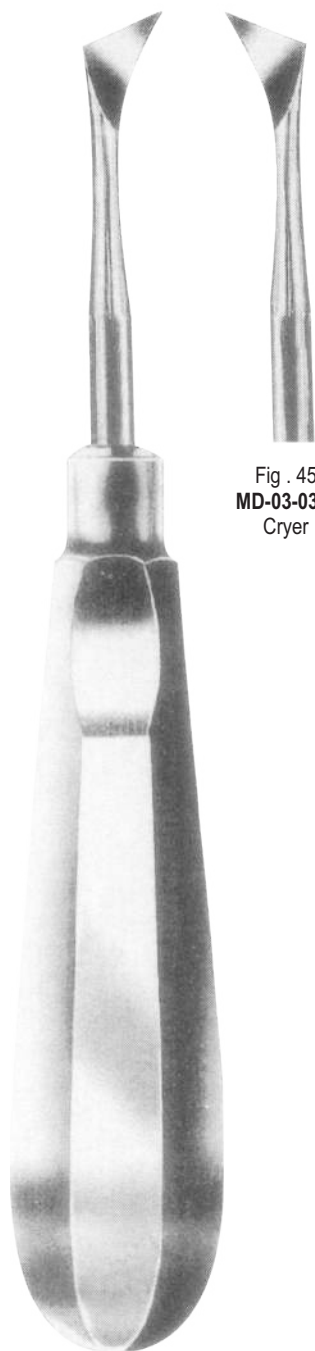


Fig . 44  
18-110-44  
Cryer



Fig . 45  
MD-03-037  
Cryer



Fig . 25  
MD-03-038  
Cryer



Fig . 26  
MD-03-039  
Cryer



Fig . 31  
MD-03-040  
Cryer



Fig . 32  
MD-03-041  
Cryer



Fig . 80  
MD-03-042



Fig . 81  
MD-03-043



Fig . 81A  
MD-03-045



Fig . 81E  
MD-03-046



Fig . 190  
MD-03-0467



Fig . 191  
MD-03-048



Fig . 23  
MD-03-049



Fig . 24  
MD-03-050



Fig . 98  
MD-03-051



ROOT ELEVATORS

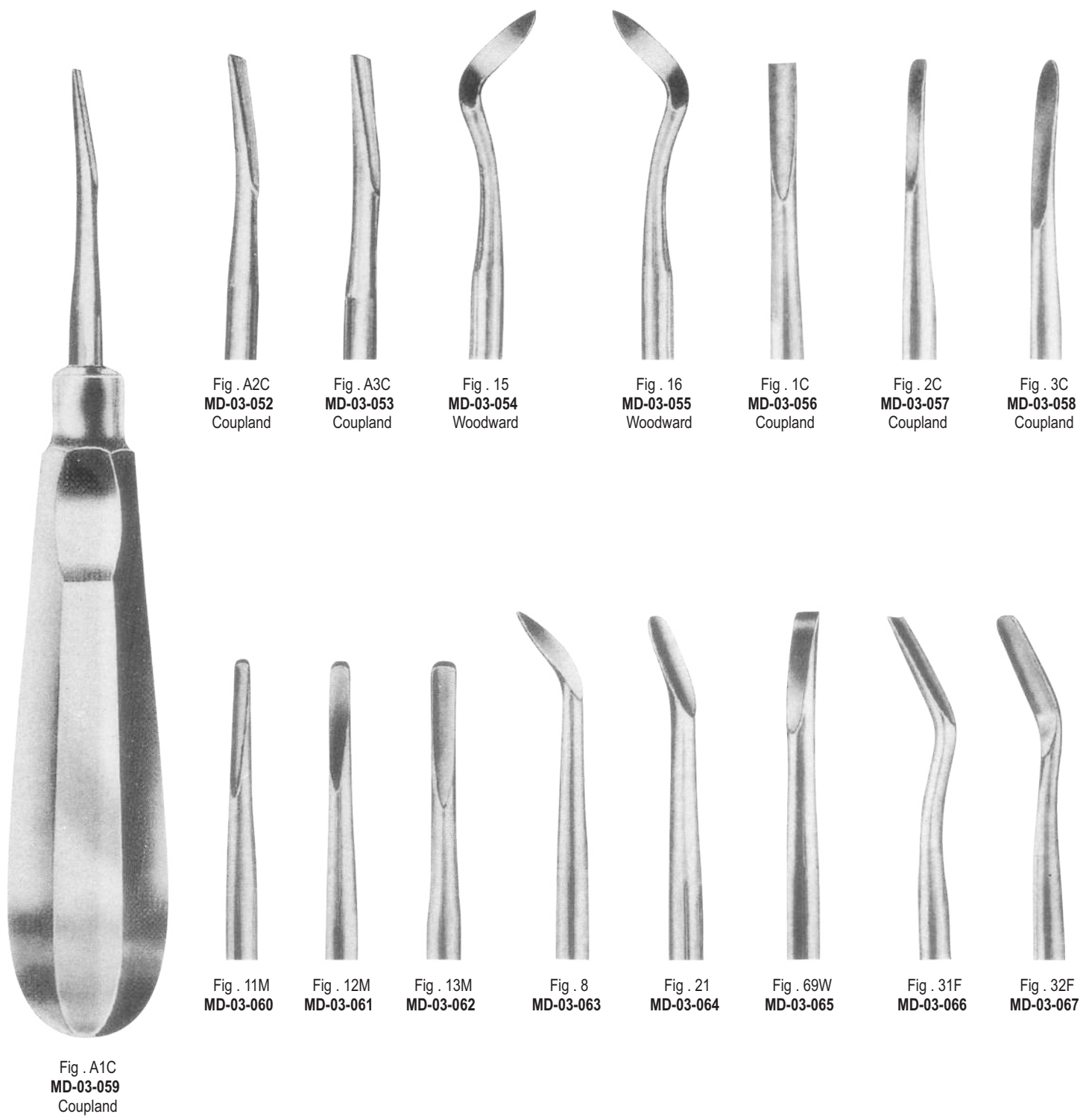


Fig . A2C  
MD-03-052  
Coupland

Fig . A3C  
MD-03-053  
Coupland

Fig . 15  
MD-03-054  
Woodward

Fig . 16  
MD-03-055  
Woodward

Fig . 1C  
MD-03-056  
Coupland

Fig . 2C  
MD-03-057  
Coupland

Fig . 3C  
MD-03-058  
Coupland

Fig . 11M  
MD-03-060

Fig . 12M  
MD-03-061

Fig . 13M  
MD-03-062

Fig . 8  
MD-03-063

Fig . 21  
MD-03-064

Fig . 69W  
MD-03-065

Fig . 31F  
MD-03-066

Fig . 32F  
MD-03-067

Fig . A1C  
MD-03-059  
Coupland



Bein

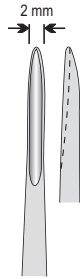


Fig. 1  
MD-03-068

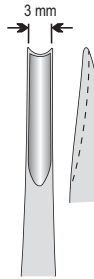


Fig. 2  
MD-03-069

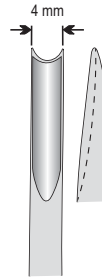


Fig. 3  
MD-03-070

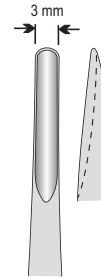


Fig. 4  
MD-03-071

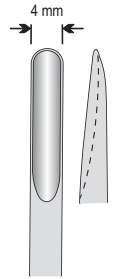


Fig. 5  
MD-03-072

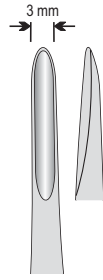


Fig. 6  
MD-03-073

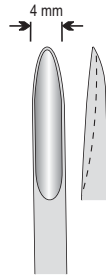


Fig. 7  
MD-03-074

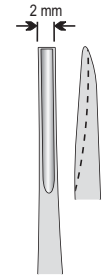


Fig. 8  
MD-03-075

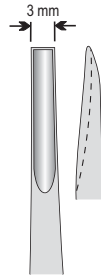


Fig. 9  
MD-03-076

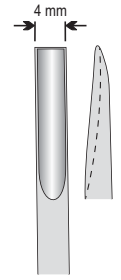


Fig. 10  
MD-03-077

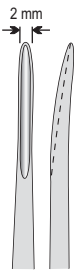


Fig. 1  
MD-03-078

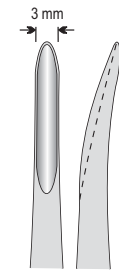


Fig. 2  
MD-03-079

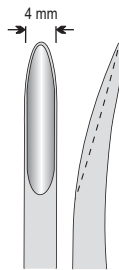


Fig. 3  
MD-03-080

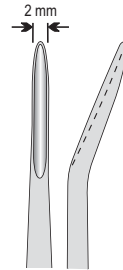


Fig. 1  
MD-03-081

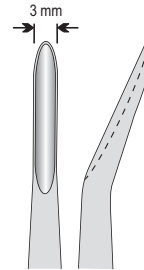


Fig. 2  
MD-03-082

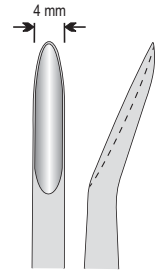


Fig. 3  
MD-03-083

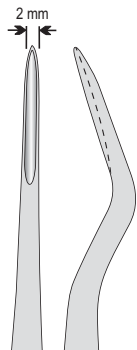


Fig. 1  
MD-03-084  
Bayonet Distal

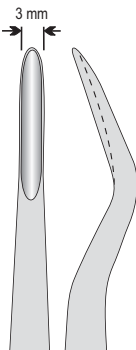


Fig. 2  
MD-03-085  
Bayonet Distal

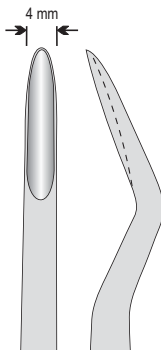


Fig. 3  
MD-03-086  
Bayonet Distal

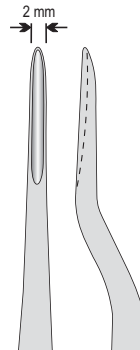


Fig. 1  
MD-03-087  
Bayonet Mesial

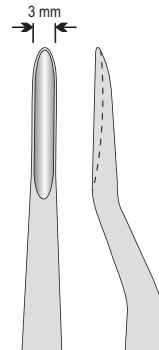


Fig. 2  
MD-03-088  
Bayonet Mesial

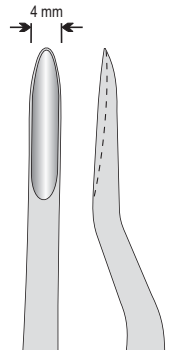
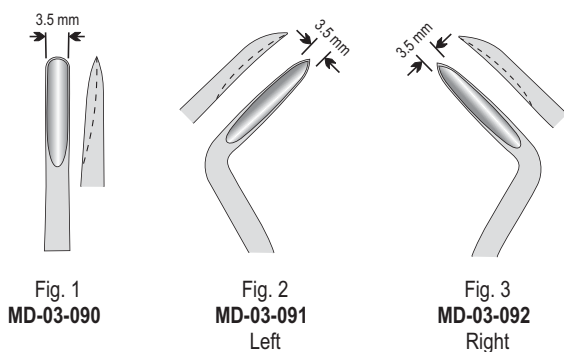


Fig. 3  
MD-03-089  
Bayonet Mesial

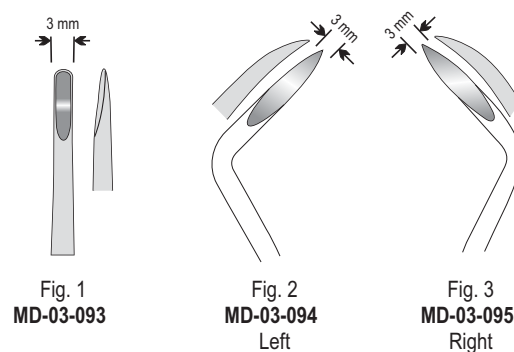
Root Elevators



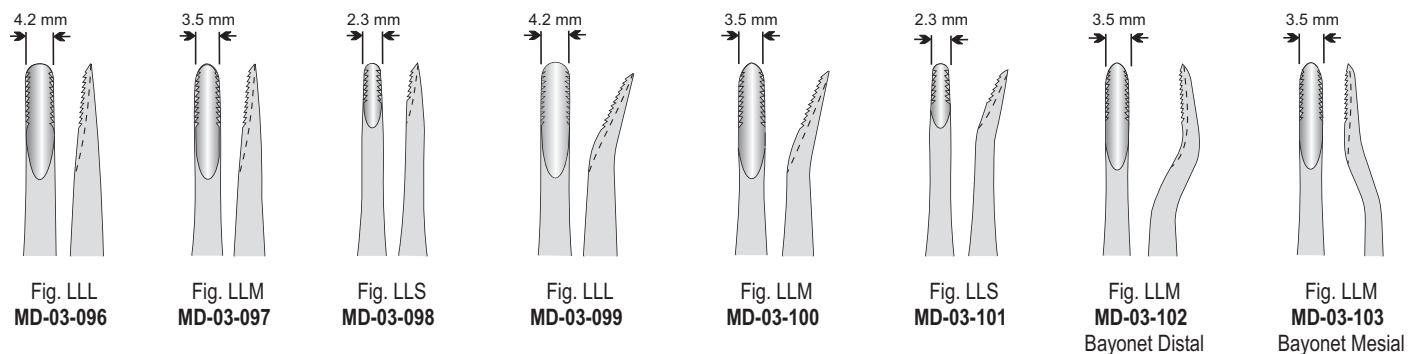
Flohr



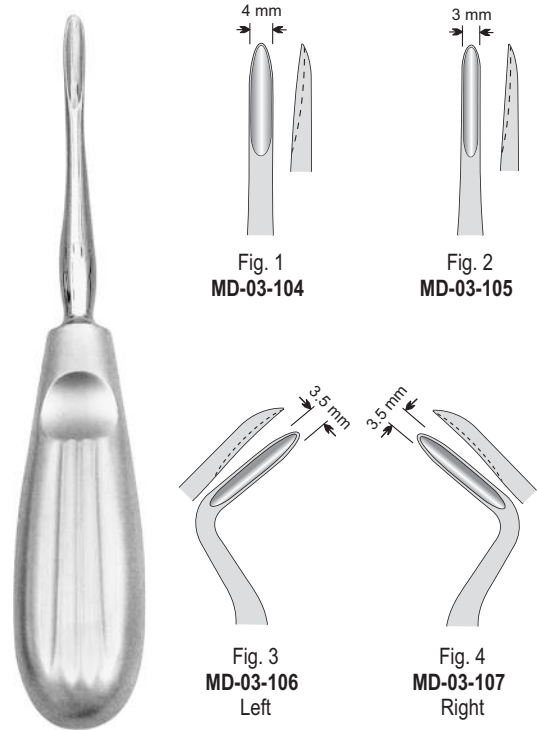
Friedman



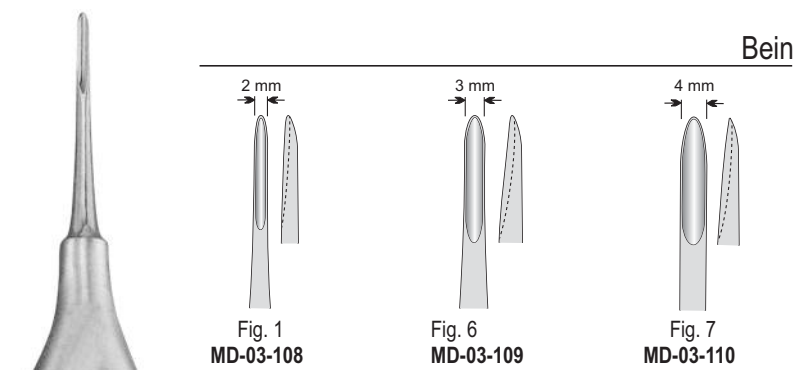
Lindo-Levian



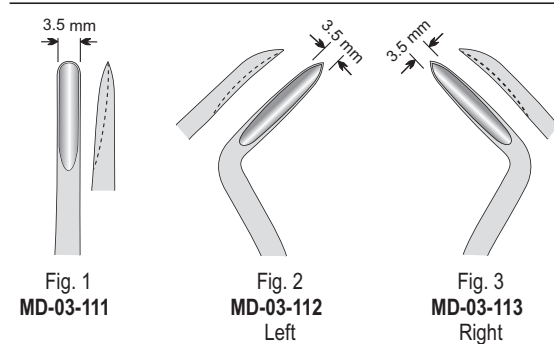
Hylin



Bein



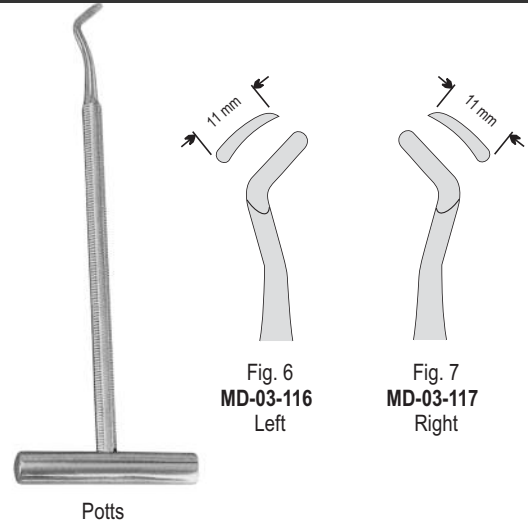
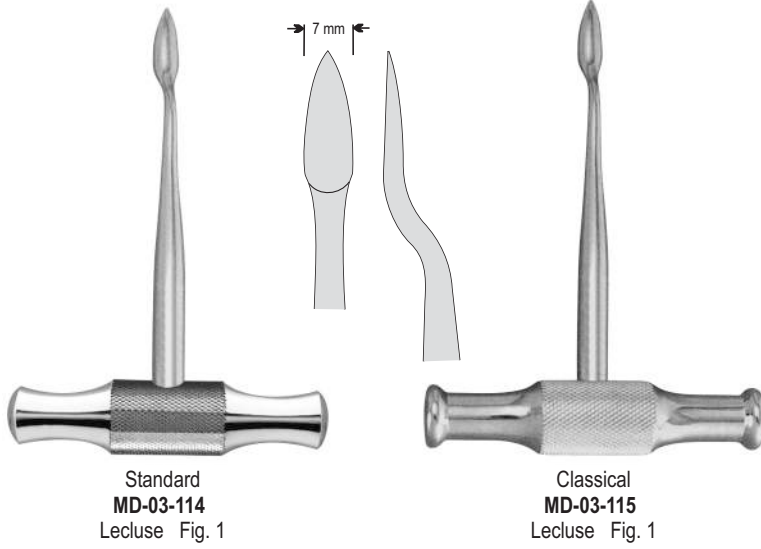
Flohr



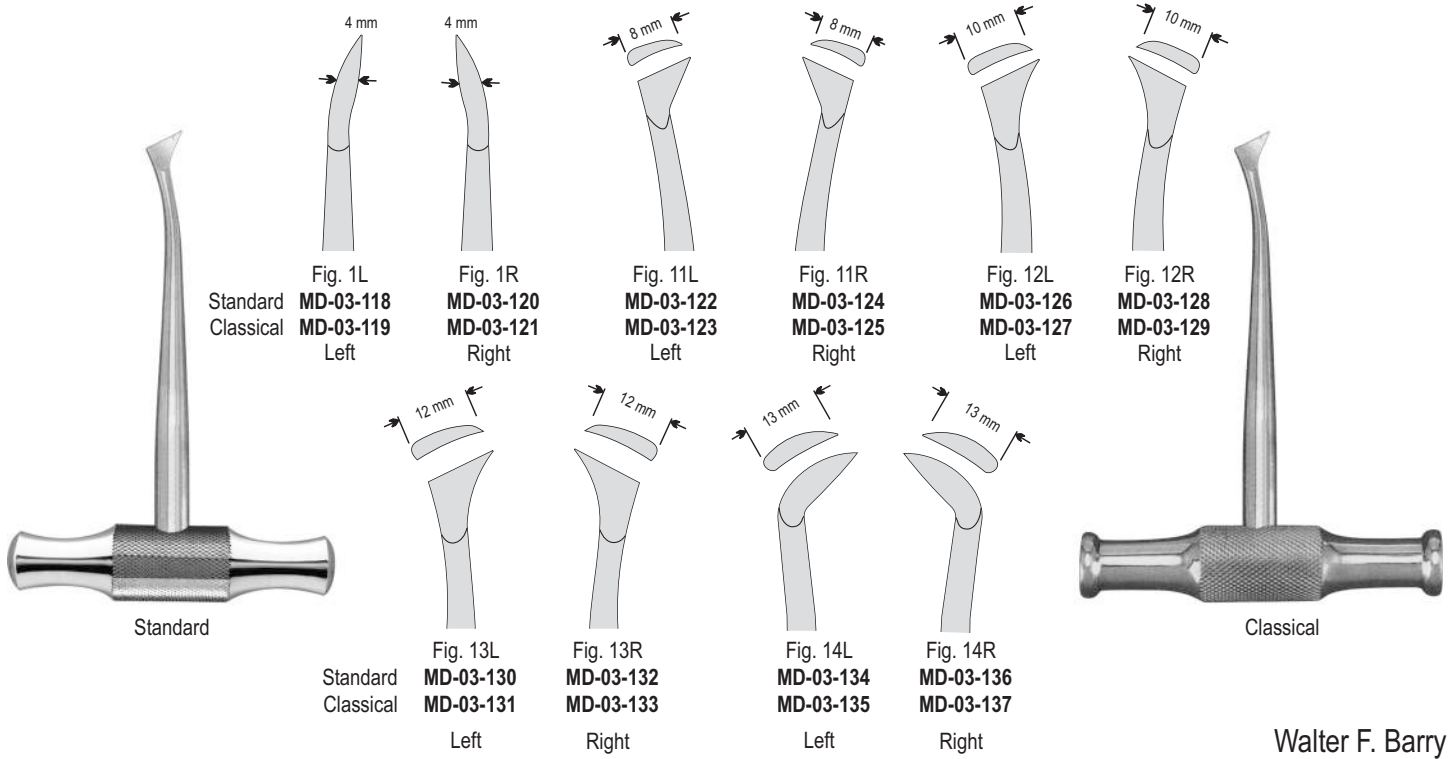




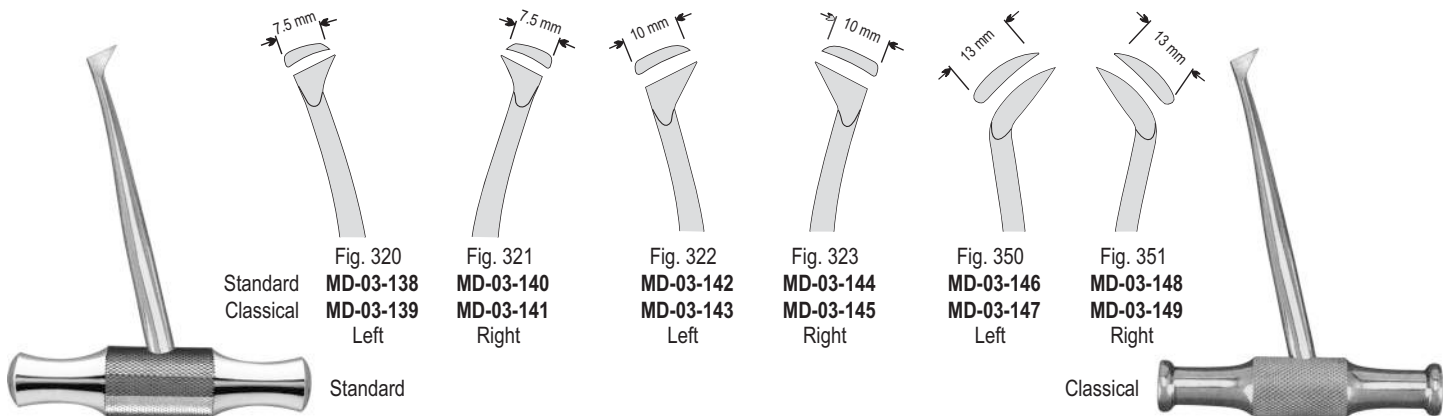
## ROOT ELEVATORS



Winter



Walter F. Barry



**MALLEABLE & DUCTILE**  
INSTRUMENTS

**04**

**Page 50-55**

**scissors**

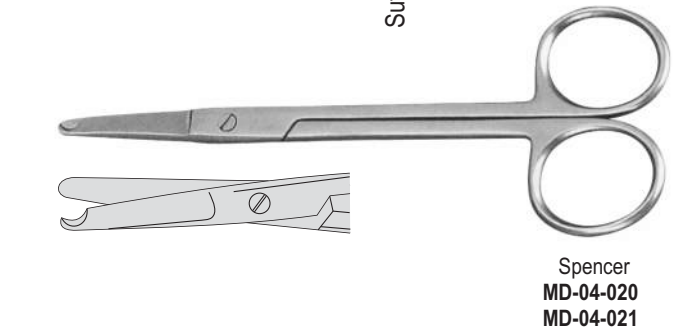
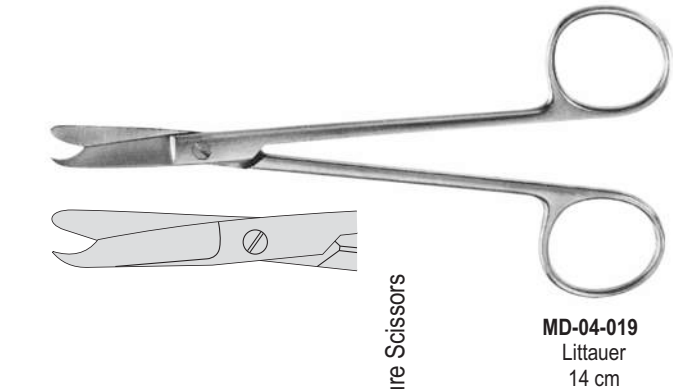
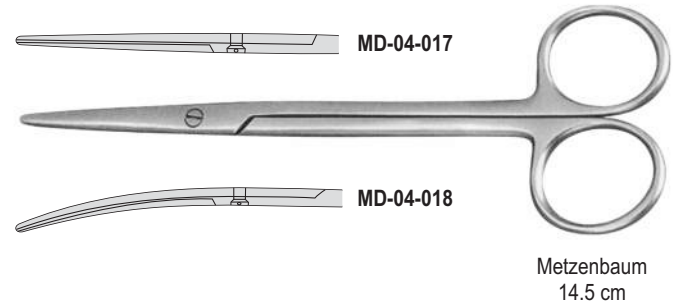
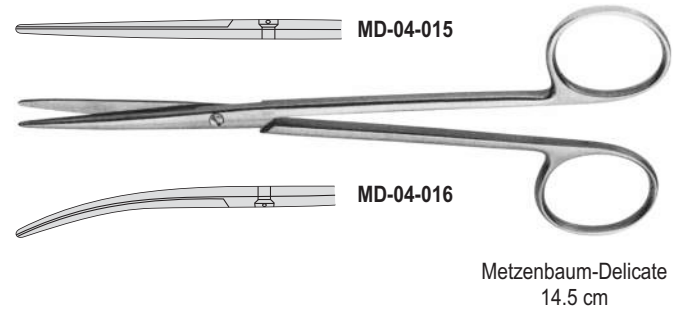
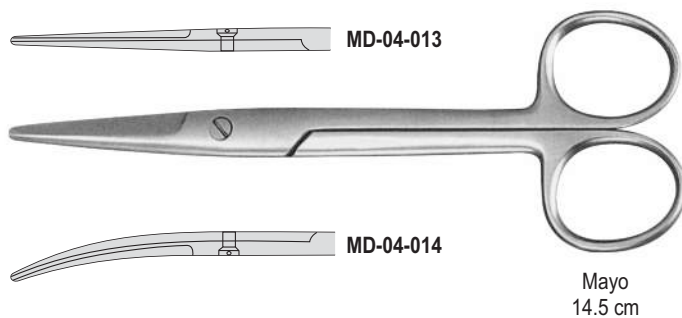
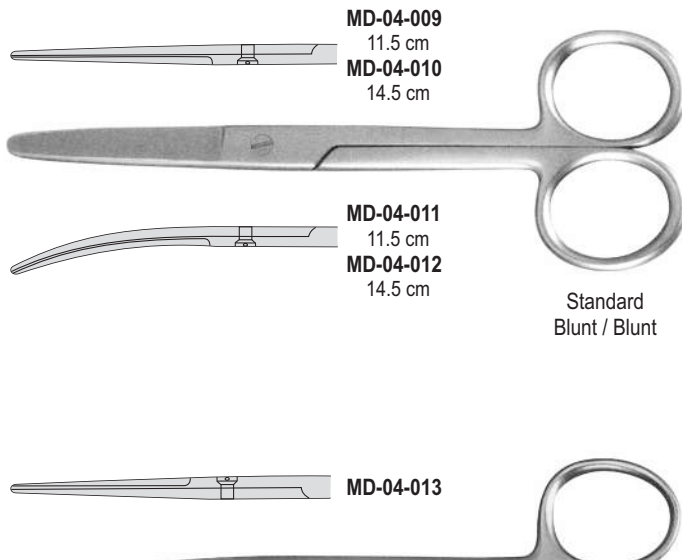
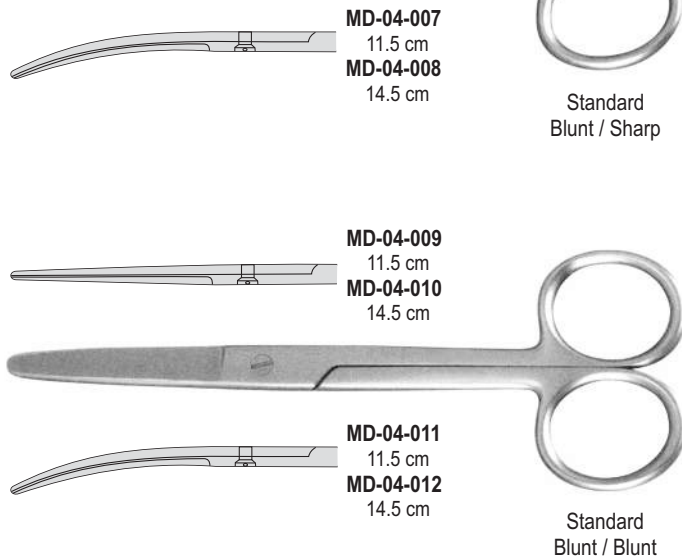
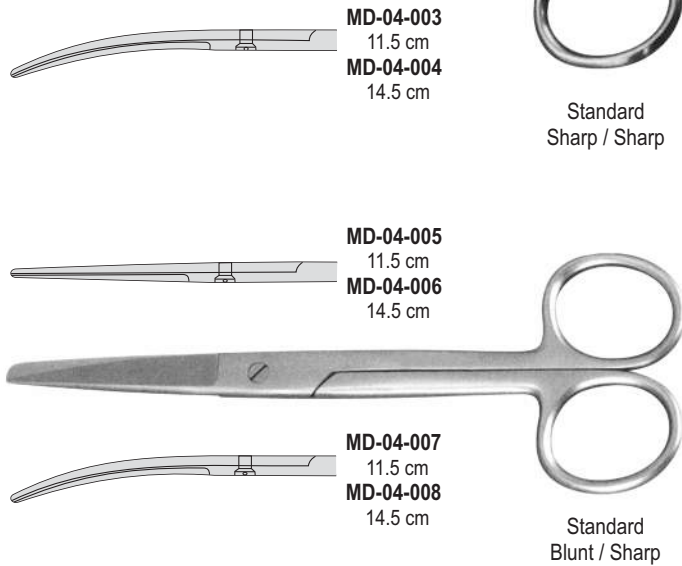
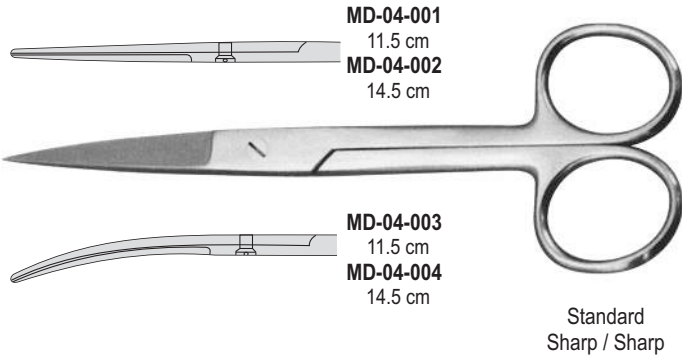
Operating Scissors

Scissors With Tungsten Carbide Inserts

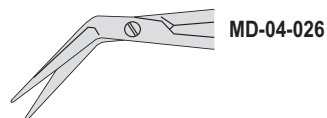
Micro Scissors

Super Cut Scissors

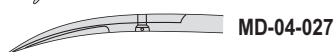




**GUM & OPERATING SCISSORS**



**MD-04-026**



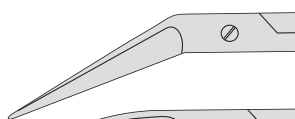
**MD-04-027**



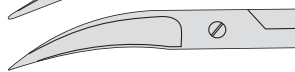
**MD-04-028**



**Noyes / Castroviejo**  
12 cm



**MD-04-029**



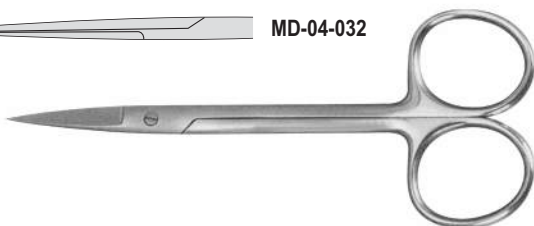
**MD-04-030**



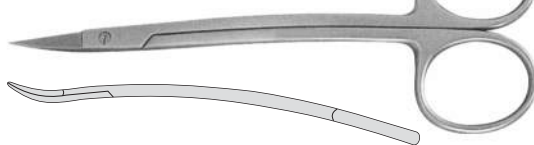
**MD-04-031**



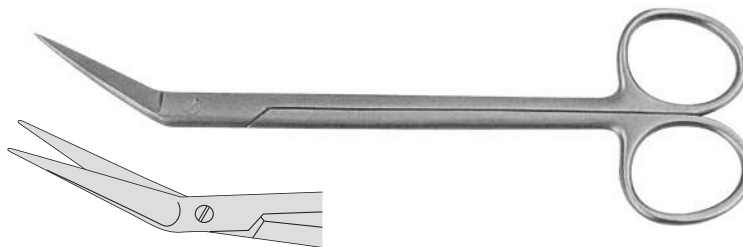
**MD-04-032**



**Iris**  
11.5 cm



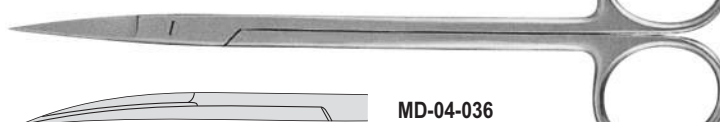
**MD-04-033**  
**La Grange**  
11.5 cm



**MD-04-034**  
**Kelly**  
16 cm



**MD-04-035**



**MD-04-036**

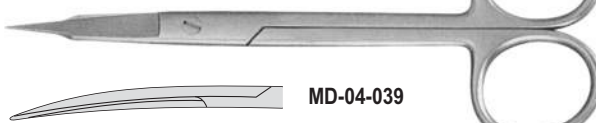
**Kelly**  
16 cm



**MD-04-037**  
**Goldman-Fox**  
13 cm



**MD-04-038**



**MD-04-039**

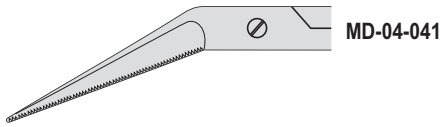
**Goldman-Fox**  
13 cm



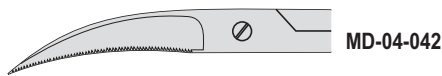
**MD-04-040**  
**Universal**  
18 cm

**Scissors, One Blade Serrated**

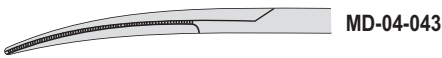
- One blade is with fine serrations to avoid tissue or ligature slippage.
- Manufactured from high quality stainless steel to provide longer-lasting cutting edge.
- Single black ring for easy identification.



MD-04-041



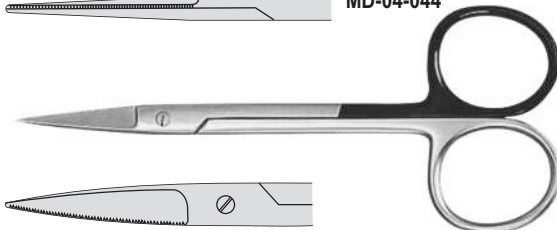
MD-04-042



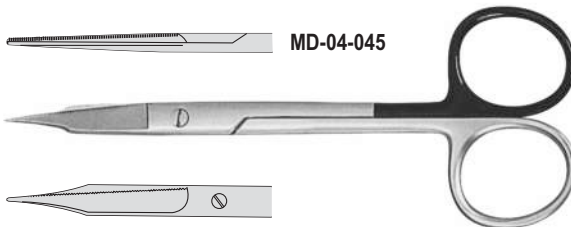
MD-04-043



MD-04-044



Iris  
11.5 cm



MD-04-045



Goldman-Fox  
13 cm



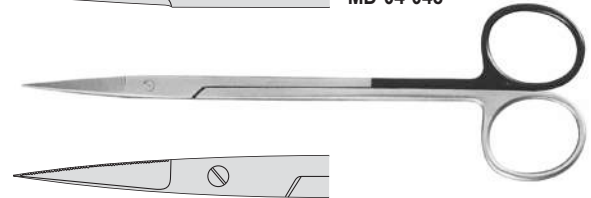
MD-04-046  
Goldman-Fox  
13 cm



MD-04-047



MD-04-048



Kelly  
16 cm



MD-04-049  
Locklin  
16 cm

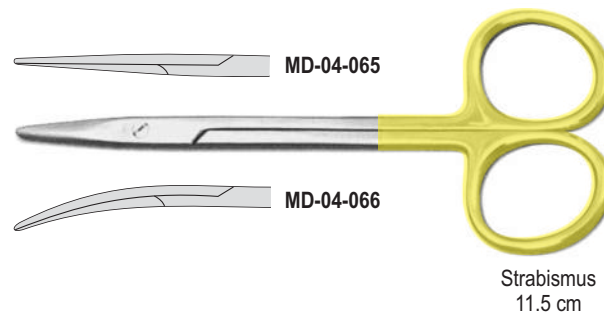
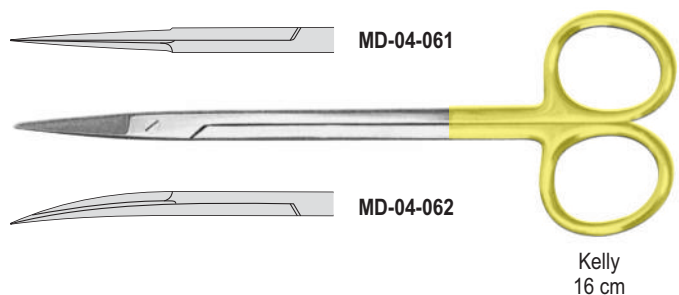
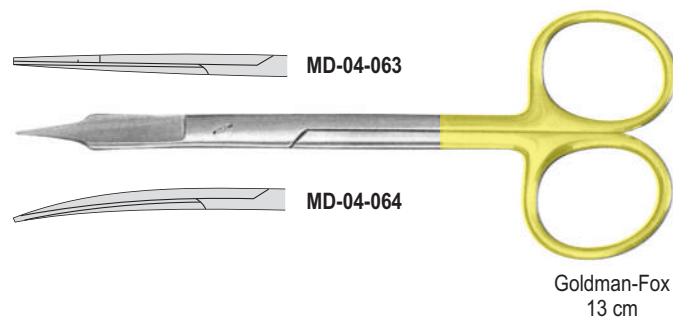
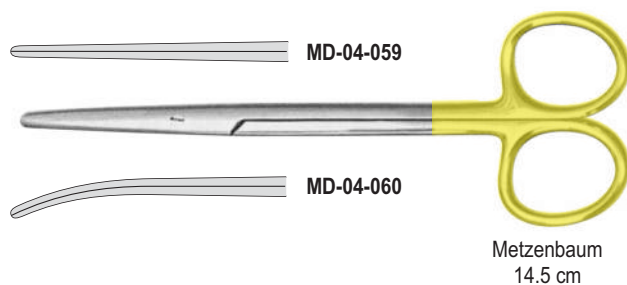
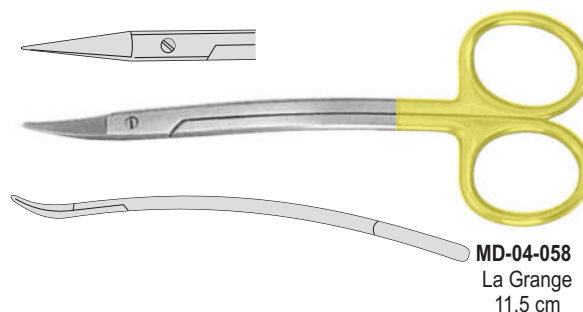
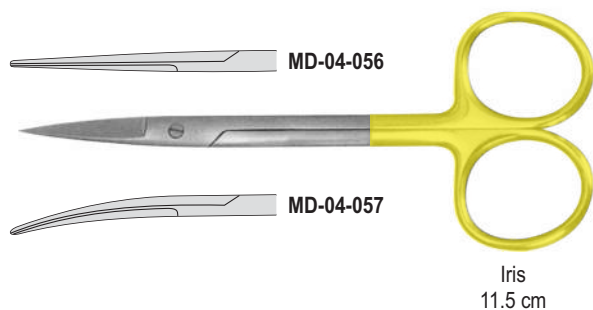
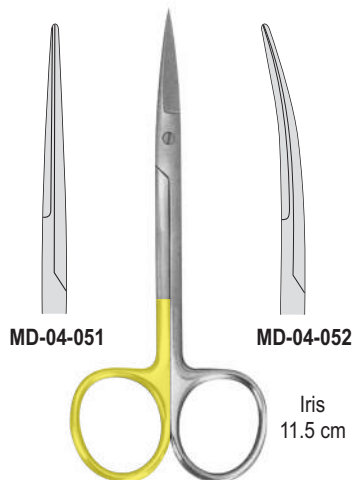


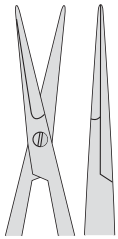
MD-04-050  
Locklin  
16 cm

## SCISSORS WITH TUNGSTEN CARBIDE INSERTS

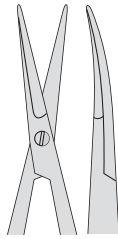
### Super-Cut

- Cutting Blade horned to "razor" sharpness with opposing blade finished with fine serrations to avoid tissue slippage.
- Extremely smooth cutting with less trauma.
- Manufactured from high quality stainless steel to provide longer-lasting cutting edge.
- Single gold plated ring for easy identification.





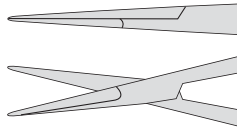
**MD-04-067**  
15 cm



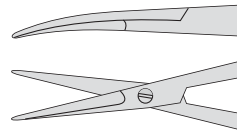
**MD-04-068**  
15 cm



Micro Scissor  
Stainless Steel



**MD-04-069**  
18 cm



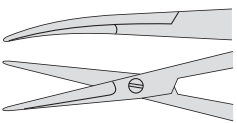
**MD-04-070**  
18 cm



Micro Scissor  
Stainless Steel

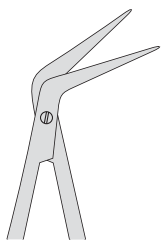


Micro Scissor  
Stainless Steel  
for ligature, one  
blade serrated

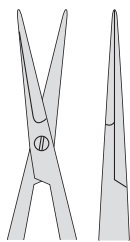


**MD-04-071**  
18 cm

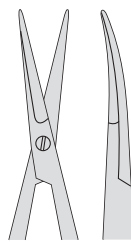
### Micro Scissors with Titanium Stainless Steel Tips



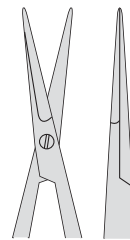
**MD-04-072**  
18 cm



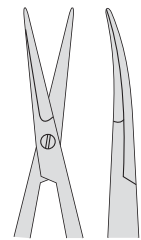
**MD-04-073**  
18 cm



**MD-04-074**  
18 cm



**MD-04-075**  
15.5 cm



**MD-04-076**  
15.5 cm



**MALLEABLE & DUCTILE**  
INSTRUMENTS

**05**

**Page 56-65**

**Tweezers**

Tweezers

Dressing & Dissecting Forceps

Haemostatic Forceps

Needle Holders

Needle Holders with Tungsten Carbide Inserts

Micro Needle Holders & Forceps







## TWEEZERS, DISSECTING & TISSUE FORCEPS

### Tweezers



**MD-05-001**  
College  
15 cm



**MD-05-002**  
College  
15 cm

Fig. 8



**MD-05-003**  
College-Locking  
15 cm



**MD-05-004**  
Flagg  
16 cm



**MD-05-005**  
Meriam  
16 cm



**MD-05-006**  
College  
15 cm



**MD-05-007**  
Flagg  
16 cm



**MD-05-008**  
Meriam  
16 cm



**MD-05-009**  
Perry  
13 cm



**MD-05-010**  
Perry  
13 cm



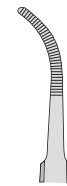
**MD-05-011**  
College TOE  
15 cm



**MD-05-012**  
Meriam TOE  
16 cm



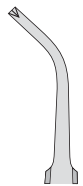
**MD-05-013**



**MD-05-014**



**MD-05-015**



**MD-05-016**



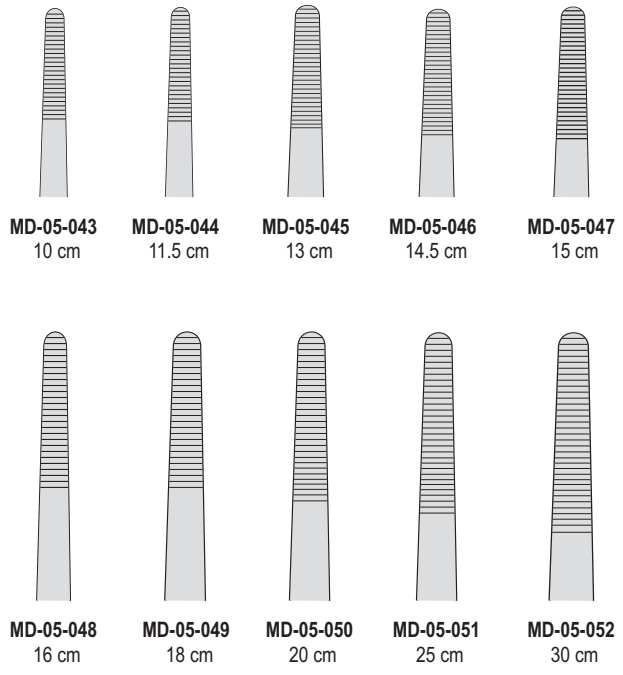
Gerald  
18 cm



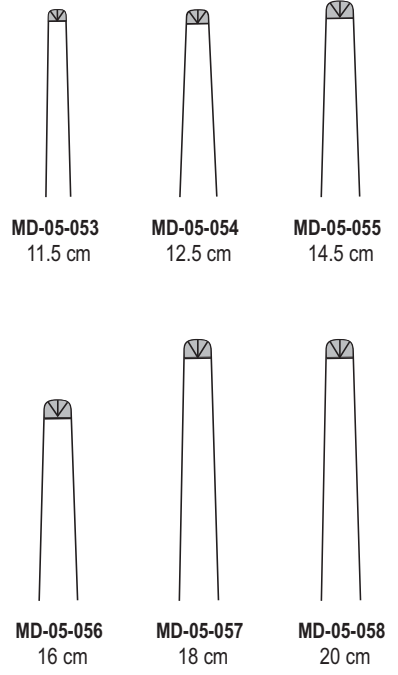
Gerald  
18 cm

**DISSECTING & TISSUE FORCEPS**





Standard Dressing Forceps

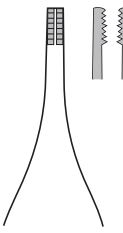


Standard Dissecting Forceps

### Tissue Forceps

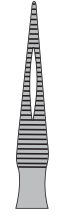


MD-05-059  
Adson-Brown  
12 cm

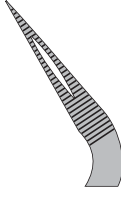


Stieglitz

### Splinter Forceps



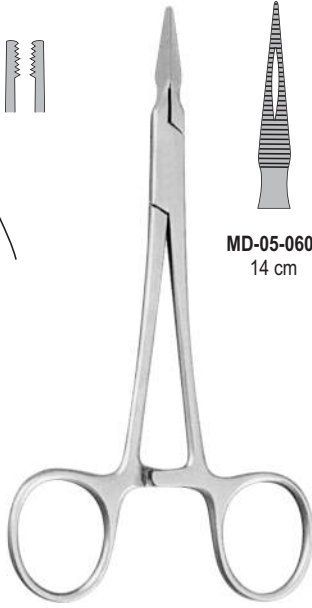
MD-05-060  
14 cm



MD-05-061  
13.5 cm



MD-05-062  
12.5 cm



### Towel Forceps



Backhaus  
MD-05-063 9 cm  
MD-05-064 11 cm  
MD-05-065 13 cm



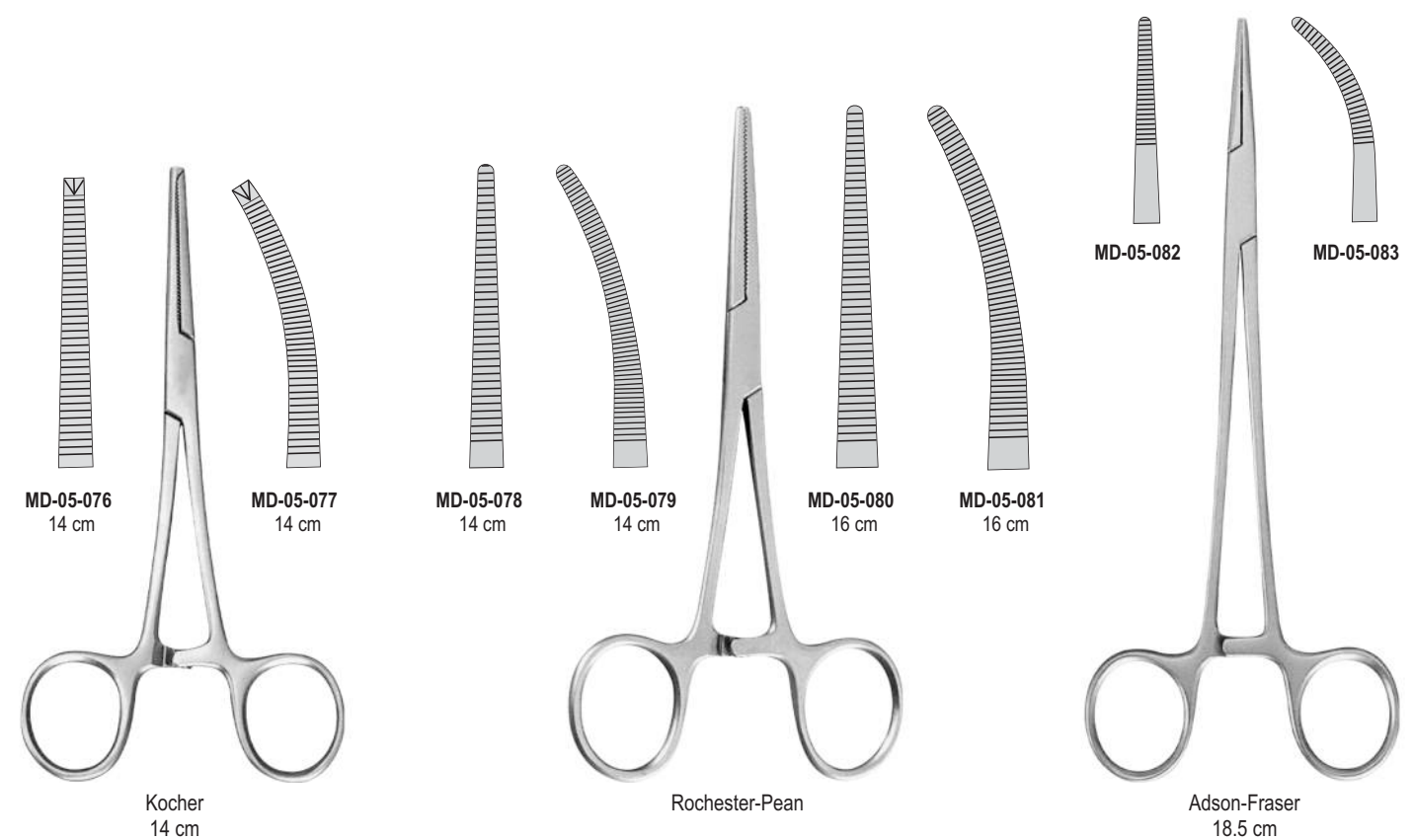
MD-05-066  
Jones  
9 cm



MD-05-067  
Schaedel  
9 cm



HAEMOSTATIC FORCEPS





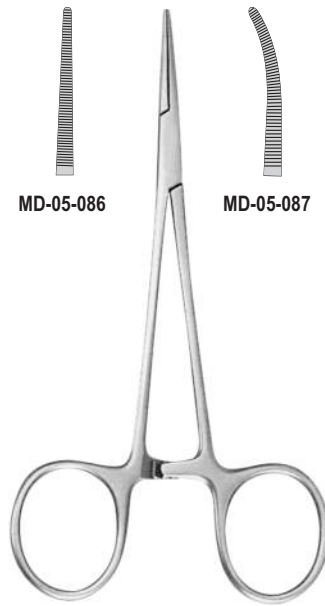
HAEMOSTATIC & DRESSING FORCEPS



MD-05-084

MD-05-085

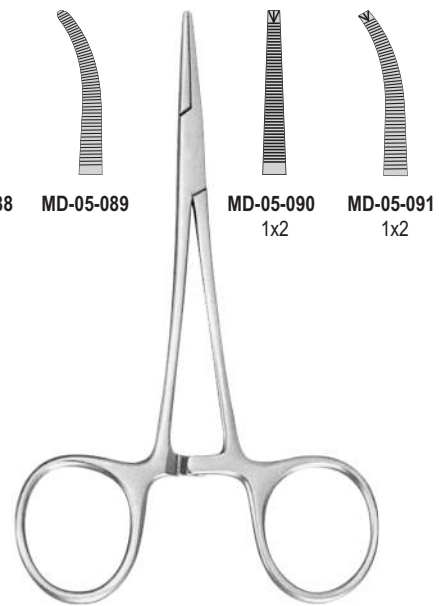
Hartman  
10 cm



MD-05-086

MD-05-087

Micro Mosquito  
12.5 cm



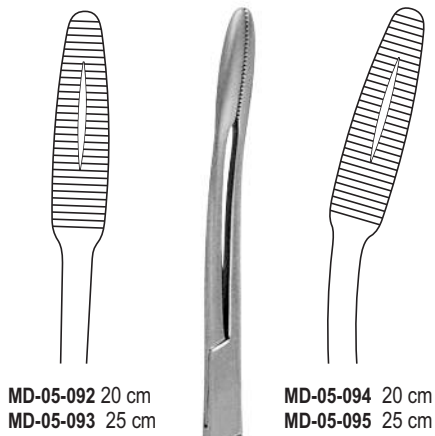
MD-05-088

MD-05-089

MD-05-090  
1x2

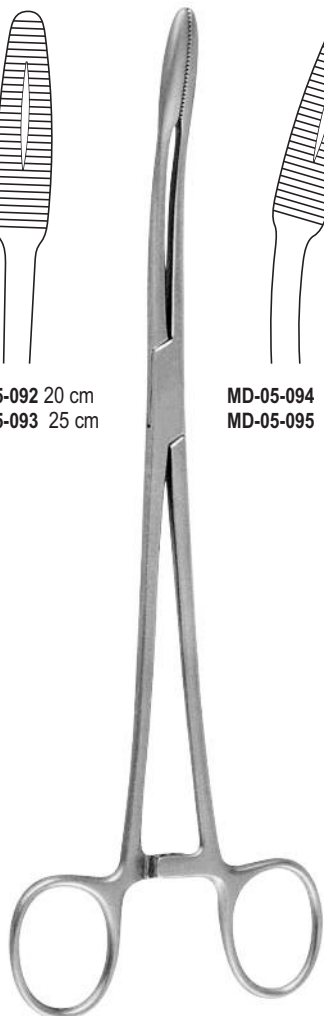
MD-05-091  
1x2

Halsted-Mosquito  
12.5 cm

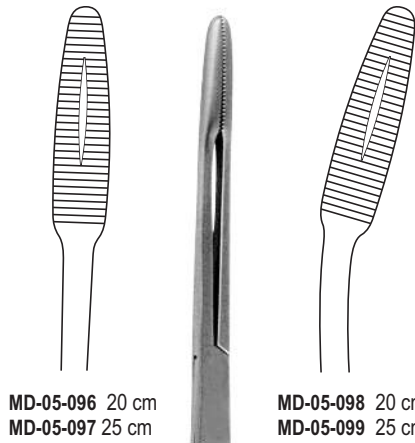


MD-05-092 20 cm  
MD-05-093 25 cm

MD-05-094 20 cm  
MD-05-095 25 cm

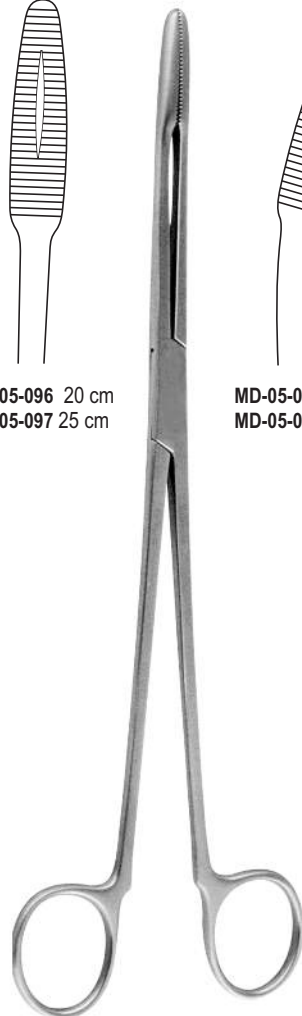


Dressing Forceps  
Gross-Maier

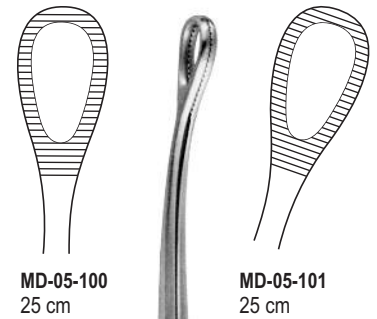


MD-05-096 20 cm  
MD-05-097 25 cm

MD-05-098 20 cm  
MD-05-099 25 cm



Dressing Forceps  
Gross-Maier  
without ratchet



MD-05-100  
25 cm

MD-05-101  
25 cm



Sponge Forceps  
Forester

NEEDLE HOLDERS



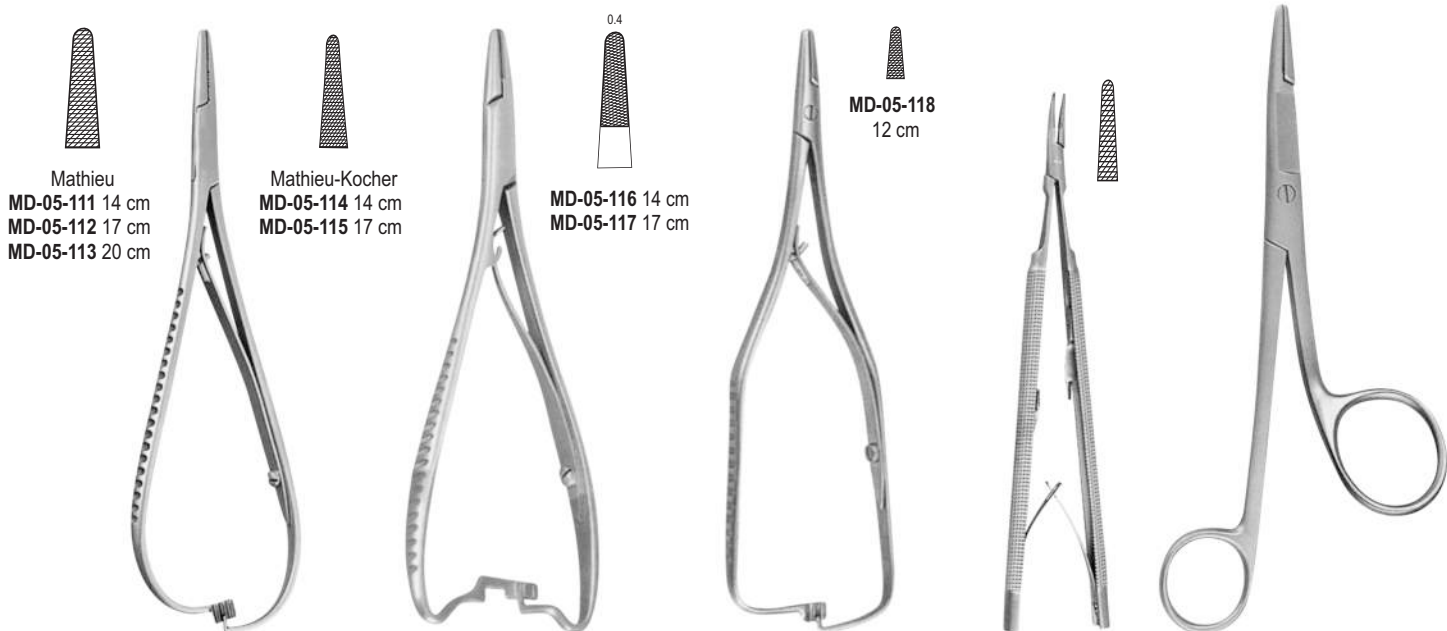
**MD-05-102**  
 Derf  
 12.5 cm

**MD-05-103**  
 Olsen-Hegar  
 with scissor  
 14 cm

**MD-05-104**  
 Baumgartner  
 14.5 cm

**MD-05-105**  
 Crilewood  
 15 cm

Mayo-Hegar  
**MD-05-106** 14 cm  
**MD-05-107** 15 cm  
**MD-05-108** 16 cm  
**MD-05-109** 18 cm  
**MD-05-110** 20 cm



Mathieu  
**MD-05-111** 14 cm  
**MD-05-112** 17 cm  
**MD-05-113** 20 cm

Mathieu-Kocher  
**MD-05-114** 14 cm  
**MD-05-115** 17 cm

0.4  
**MD-05-116** 14 cm  
**MD-05-117** 17 cm

**MD-05-118**  
 12 cm

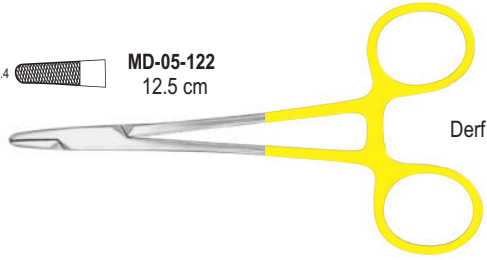
Mathieu

Boynton

**MD-05-119**  
 Castroviejo  
 13 cm

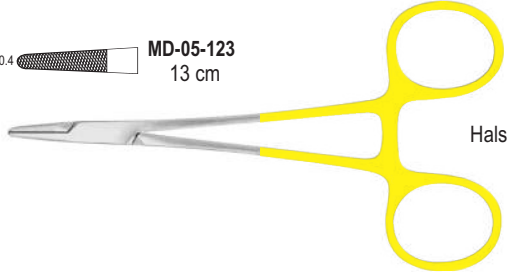
Gillies with Scissor 16 cm  
**MD-05-120** Left handed  
**MD-05-121** Right handed

MD-05-122  
12.5 cm



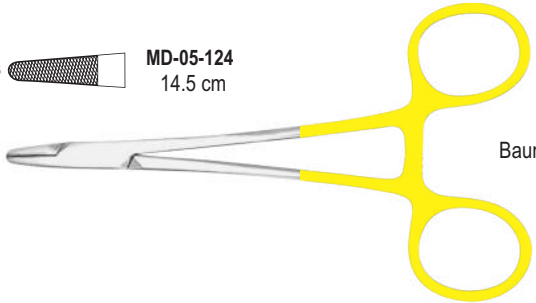
Derf

MD-05-123  
13 cm



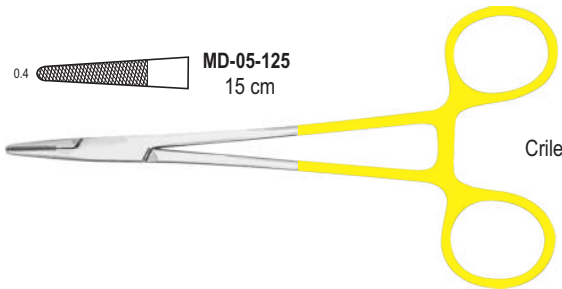
Halsey

MD-05-124  
14.5 cm



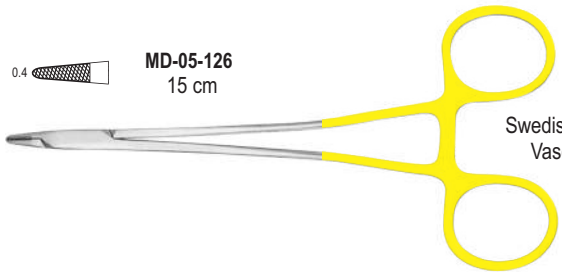
Baumgartner

MD-05-125  
15 cm



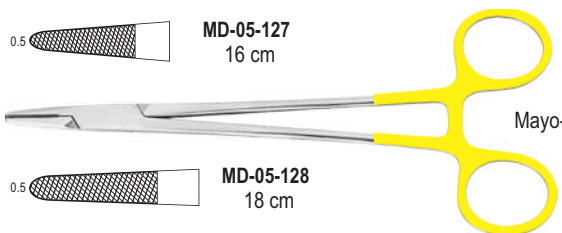
Crilewood

MD-05-126  
15 cm



Swedish-Micro  
Vascular

MD-05-127  
16 cm



Mayo-Hegar

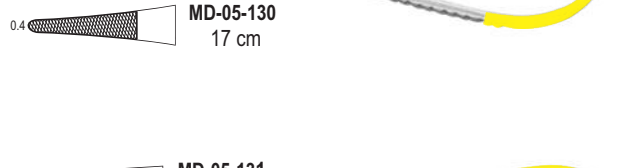
MD-05-128  
18 cm

MD-05-129  
14 cm



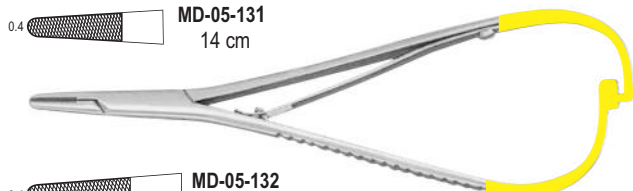
Mathieu  
Kocher

MD-05-130  
17 cm

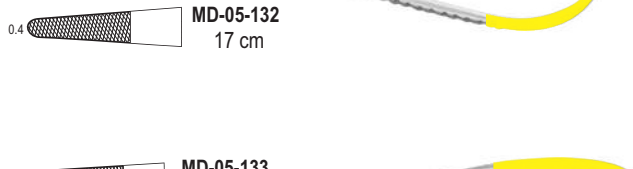


Mathieu

MD-05-131  
14 cm



MD-05-132  
17 cm



Mathieu

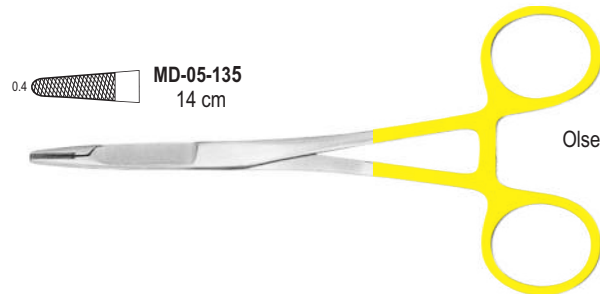
MD-05-133  
14 cm



MD-05-134  
17 cm



MD-05-135  
14 cm



Olsen-Hegar

MD-05-136  
18 cm



Toennis

NEEDLE HOLDERS

Needle Holders with Tungsten Carbide inserts



MD-05-137



MD-05-138



MD-05-139



MD-05-140



MD-05-141



MD-05-142

Castroviejo  
14 cm

Castroviejo  
14 cm

Castroviejo  
14 cm

Castroviejo  
14 cm



MD-05-143



MD-05-144

Castroviejo  
14 cm



MD-05-145



MD-05-146

Castroviejo  
14 cm



MD-05-147



MD-05-148

Castroviejo  
14 cm



MD-05-149



MD-05-150



MD-05-151

Castroviejo  
14 cm

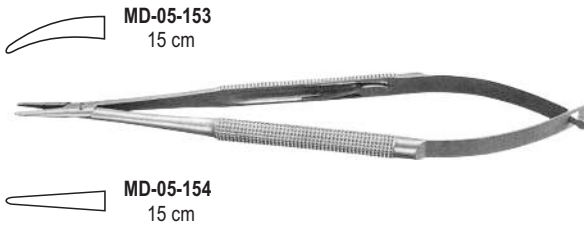


MD-05-152

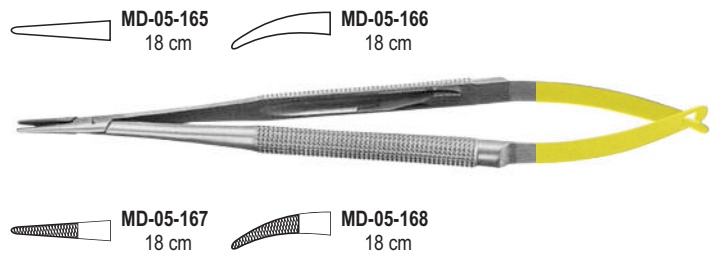
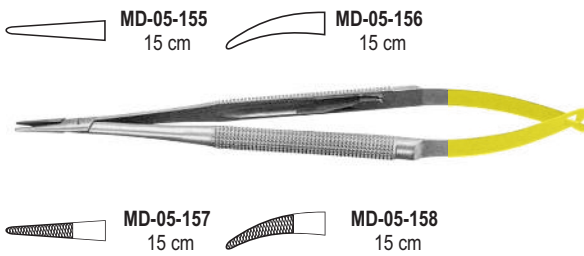
Castroviejo  
18 cm



### Micro Needle Holders Stainless Steel



### Micro Needle Holders Stainless Steel with Tungsten Carbide Inserts



### Micro Forceps Stainless Steel



**MALLEABLE & DUCTILE**  
INSTRUMENTS

**06**

**Page 66-87**

**Implantology instruments  
& Mouth Gags**

Mouth Gags

Tongue Depressors

Lips & Cheek Retractors

Retractors & Forceps

Bone Instruments & Mallets

Implantology Instruments

Periosteal Elevators

Periodontal Instruments

Bone Curettes

Files

Surgery Instruments





**MD-06-001**  
Heister  
Maunder Wood  
9.5 cm



**MD-06-002**  
Obwegeser 11 cm  
Spreading 47 mm



**MD-06-003**  
Heister  
13 cm



Molt  
**MD-06-004** 10 cm  
**MD-06-005** 11 cm  
**MD-06-006** 14 cm



Roser-Konig  
**MD-06-007** 16 cm  
**MD-06-008** 19 cm

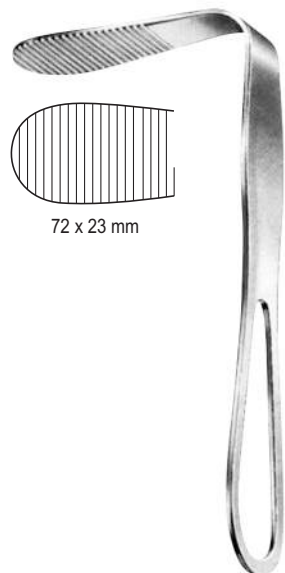


**MD-06-009**  
Denhardt  
13 cm



**MD-06-010**  
Fergusson - Ackland  
14.5 cm

**TOUNGE DEPRESSORS**



72 x 23 mm

**MD-06-011**  
 Hartmann  
 15 cm



**MD-06-012**  
 Doyen Tongue Spatula  
 13.5 cm



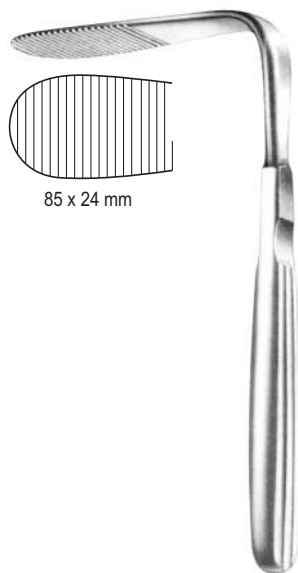
**MD-06-013**  
 14.5 cm



**MD-06-014**  
 18 cm

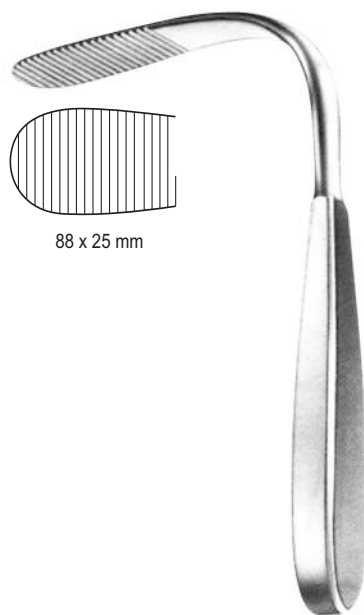


**MD-06-015**  
 Bruenings  
 19 cm



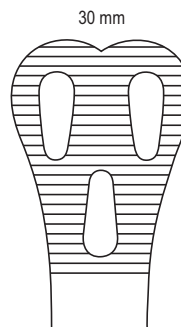
85 x 24 mm

**MD-06-016**  
 Tobold  
 15 cm



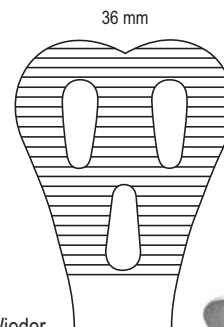
88 x 25 mm

**MD-06-017**  
 Tobold  
 16 cm



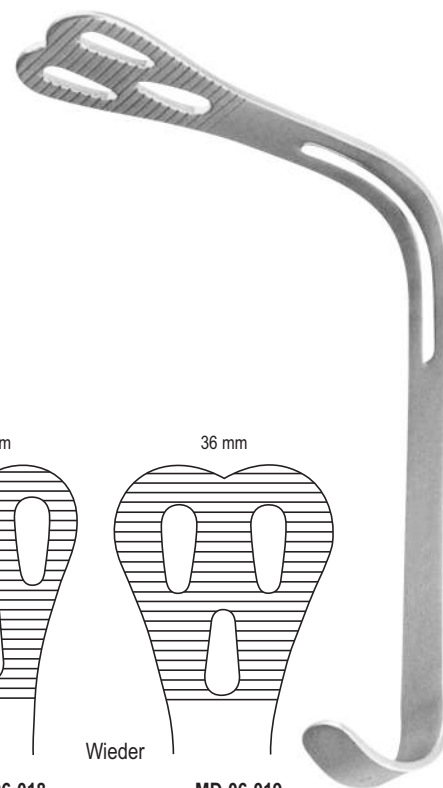
30 mm

**MD-06-018**  
 14 cm



36 mm

**MD-06-019**  
 15 cm



Wieder



**MD-06-020**  
Obwegeser Chin  
Retractor  
16.5 cm



Obwegeser 16 cm  
**MD-06-021** 8 mm  
**MD-06-022** 10 mm



**MD-06-023** 43 x 11 mm  
**MD-06-024** 57 x 11 mm  
**MD-06-025** 83 x 16 mm



35 x 11 mm

**MD-06-026**  
Obwegeser  
Spina-nasalis retractor  
22 cm



72 x 11 mm

**MD-06-027**  
Obwegeser  
Ramus retractor for  
separation of ramus & tissue  
22 cm



**MD-06-028**  
Simplex  
10.5 cm



30x19 mm

33x25 mm

**MD-06-029**  
Kilner  
15 cm



**MD-06-030**  
Minnesota  
14 cm



**MD-06-031**  
Cawood-Minnesota  
15 cm



**MD-06-032**  
Austin

LIPS & CHEEK RETRACTORS



**MD-06-033**  
 Hilger  
 Fits any simple stem mouth mirror handle



**MD-06-034**  
 Hilger  
 with handle



**MD-06-035**  
 20 cm

Finger protectors



Langenbeck

**MD-06-036** Small  
**MD-06-037** Medium  
**MD-06-038** Large



**MD-06-039**  
 Oringer  
 11.5 cm



**MD-06-040**  
 Obwegeser Cheek Retractor  
 12cm



**MD-06-041**  
 Columbia  
 14.5 cm



Sternberg

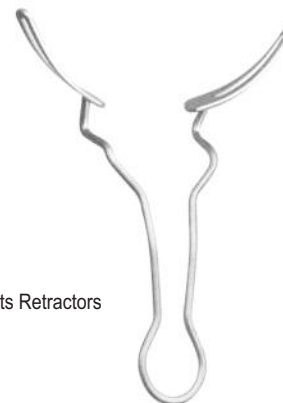
**MD-06-042** 12 cm  
**MD-06-043** 14 cm  
**MD-06-044** 15 cm



Vestibulum  
**MD-06-045**



**MD-06-046**  
 MRU

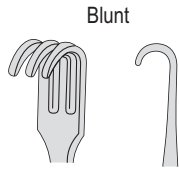


**MD-06-047**  
 MRU

Implants Retractors



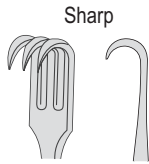
Senn-Miller  
16 cm



Blunt



MD-06-048



Sharp



MD-06-049



J & W  
16 cm

Sharp



MD-06-050



MD-06-051



MD-06-052



MD-06-053



J & W  
16 cm

Blunt



MD-06-054



MD-06-055



MD-06-056



MD-06-057



MD-06-058  
Collin Tongue holding forcep  
17 cm



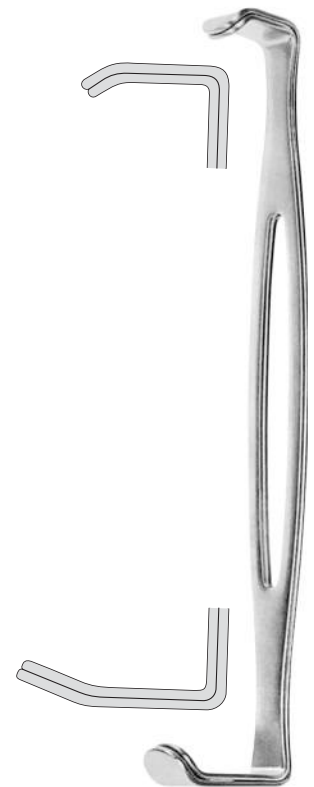
Young Tongue holding forcep  
MD-06-059 15 cm  
MD-06-060 17 cm



60-178-00  
Rubber Pad pair



MD-06-061  
Farabeuf 12 cm  
Pair

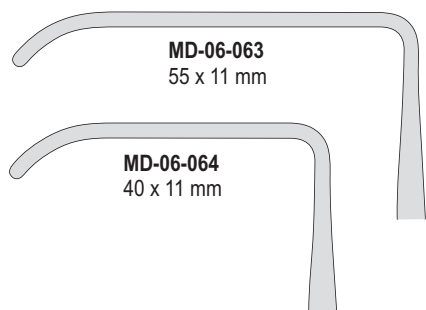


MD-06-062  
Parker-Langenbeck 21 cm  
Pair

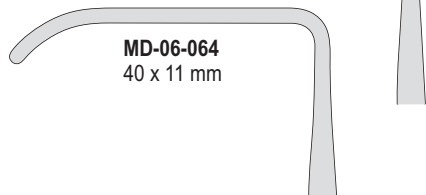
RETRACTORS



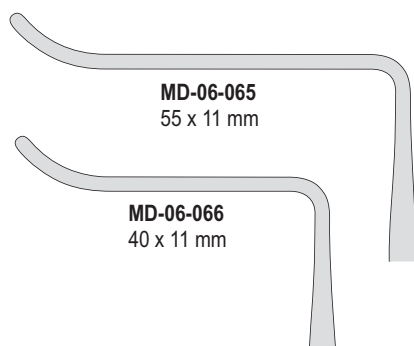
Kocher  
21.5 cm



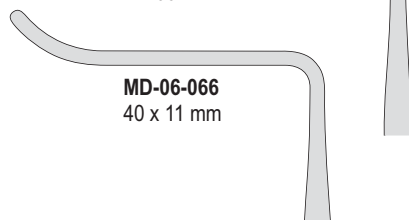
MD-06-063  
55 x 11 mm



MD-06-064  
40 x 11 mm



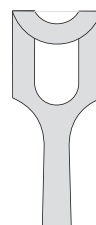
MD-06-065  
55 x 11 mm



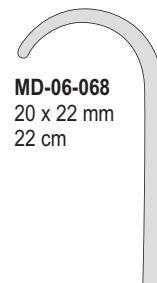
MD-06-066  
40 x 11 mm



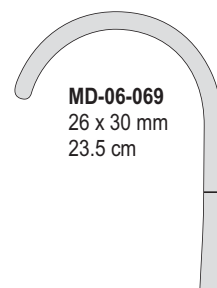
Middeldorph



MD-06-067  
14 x 17 mm  
21.5 cm



MD-06-068  
20 x 22 mm  
22 cm



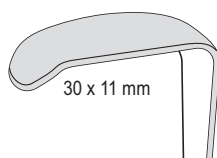
MD-06-069  
26 x 30 mm  
23.5 cm



■ Langenbeck  
22 cm

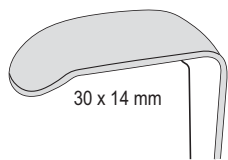


● Langenbeck  
22 cm



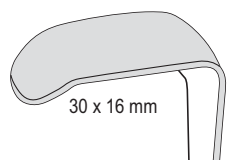
30 x 11 mm

■ MD-06-070  
● MD-06-075



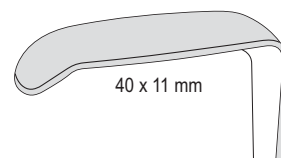
30 x 14 mm

■ MD-06-071  
● MD-06-076



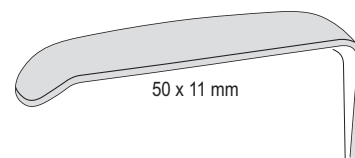
30 x 16 mm

■ MD-06-072  
● MD-06-077



40 x 11 mm

■ MD-06-073  
● MD-06-078



50 x 11 mm

■ MD-06-074  
● MD-06-079





**MD-06-080**  
Neukam  
Only Frame for Mouth Gag



Fig. 1  
**MD-06-081**  
Fig. 2  
**MD-06-082**  
Fig. 3  
**MD-06-083**

Tongue Depressors  
fenestrated blade for suction

**MD-06-084**  
Neukam  
Complete, with frame & 3 tongue depressors



**MD-06-085**  
Kilner-Doughty  
Only Frame for Mouth Gag  
14.5 cm



**MD-06-086**  
Palate plate

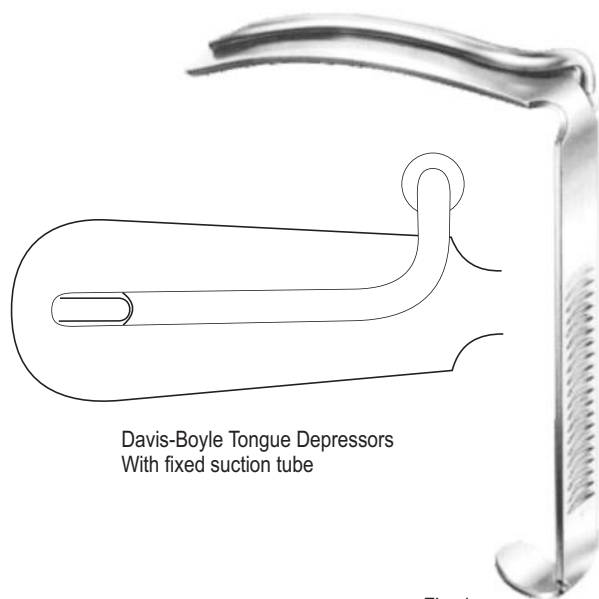
Fig. 1  
**MD-06-087**  
68 x 30 mm  
Fig. 2  
**MD-06-088**  
77 x 34 mm  
Fig. 3  
**MD-06-089**  
82 x 39 mm



Kilner-Doughty  
Tongue Depressors  
fenestrated blade for suction

**MD-06-090**  
Kilner-Doughty  
Complete, with frame, 3 tongue depressors,  
2 tooth plates & 1 palate plate

MOUTH GAGS



Davis-Boyle Tongue Depressors  
 With fixed suction tube

Fig. 1  
**MD-06-091**  
 110 x 28 mm



Fig. 2  
**MD-06-092**  
 95 x 27 mm



Fig. 3  
**MD-06-094**  
 80 x 27 mm



Fig. 4  
**MD-06-093**  
 65 x 26 mm



Fig. 5  
**MD-06-095**  
 30 x 20 mm  
 Without Suction Tube



**MD-06-096**  
 Frame for Mouth Gag with joint  
 14.5 cm

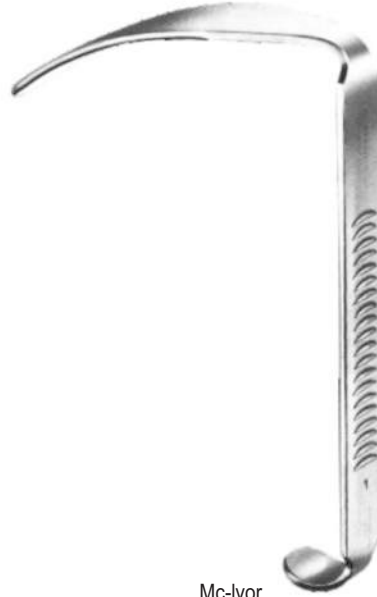
**MD-06-097**  
 Frame for Mouth Gag

**MD-06-098**  
 Silicone inlay  
 14.5 cm

**MD-06-099**  
 Davis-Boyle  
 Complete, consisting of frame  
 & 5 tongue depressors No. 1 to 5



**MD-06-100**  
Mc-Ivor  
Frame for Mouth Gag



Mc-Ivor  
Tongue Depressors

Fig. 1  
**MD-06-101**  
100 x 25 mm

Fig. 2  
**MD-06-102**  
85 x 25 mm

Fig. 3  
**MD-06-103**  
75 x 25 mm

**MD-06-104**  
Mc-Ivor  
Complete, with 3 tongue depressors



**MD-06-105**  
Dingmann  
Complete, with frame, 3 tongue depressors,  
& 2 adjustable lateral blades



Dingmann  
Tongue Depressors

Fig. 1  
**MD-06-106**  
62 x 26 mm

Fig. 2  
**MD-06-107**  
65 x 30 mm

Fig. 3  
**MD-06-108**  
78 x 32 mm

## MOUTH GAGS



Jennings  
**MD-06-109** 10.5 cm  
**MD-06-110** 12.5 cm  
**MD-06-111** 14.5 cm  
**MD-06-112** 16.5 cm

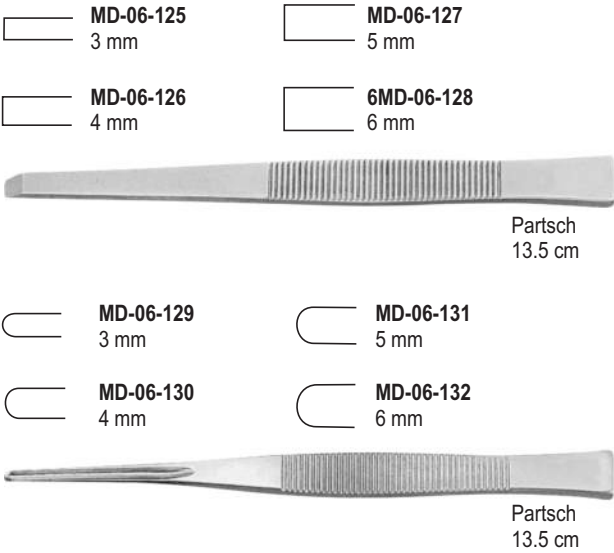
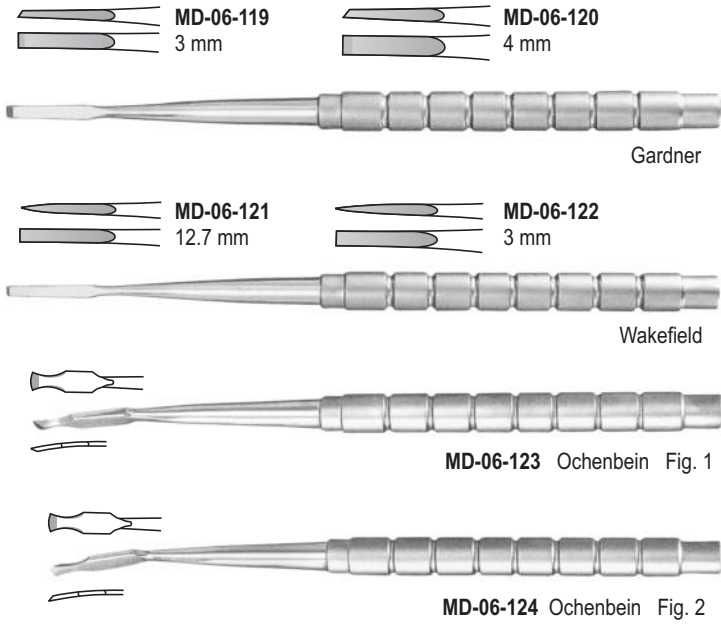


Whitehead Mouth Gag  
**MD-06-113** 11cm  
**MD-06-114** 13cm  
**MD-06-115** 15cm

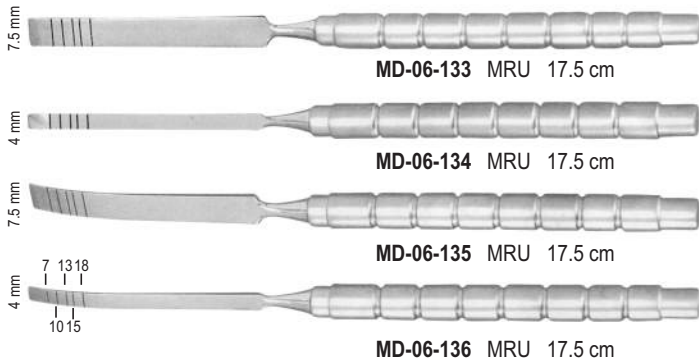


Cheek Retractor  
**MD-06-116** Small  
**MD-06-117** Medium  
**MD-06-118** Large

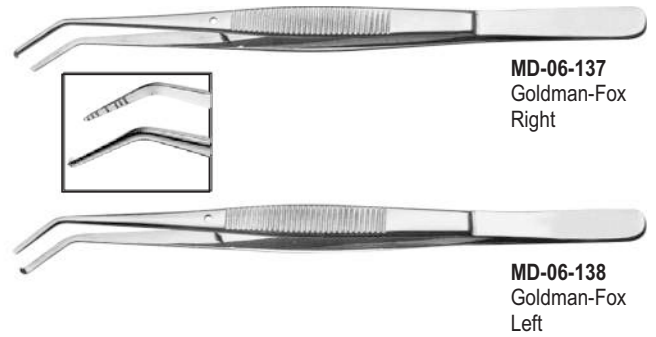
Chisels & Gouges



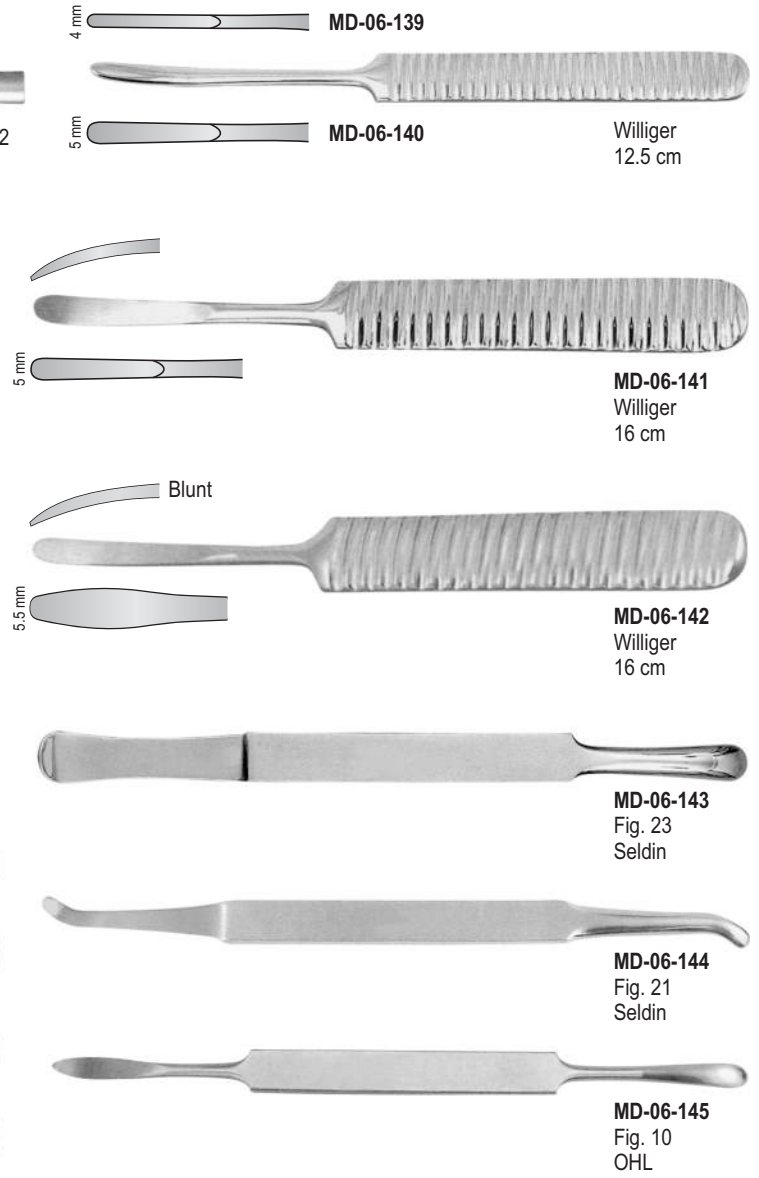
Osteotomes



Pocket Markers



Elevators & Raspatories



## IMPLANTOLOGY INSTRUMENTS

### Osteotomes



15.5 cm

# 1	Diam.
0	Ø 1.60
7.5	Ø 1.80
10	Ø 2.00
13.5	Ø 2.40
15.5	Ø 3.60

# 1  
Ø 1.6 mm



**MD-06-146**  
15.5 cm

# 2	Diam.
0	Ø 1.90
7.5	Ø 2.20
10	Ø 2.35
13.5	Ø 3.30
15.5	Ø 3.40
23.5	Ø 4.50

# 2  
Ø 1.9 mm



**MD-06-147**  
15.5 cm

# 3	Diam.
0	Ø 2.80
7.5	Ø 3.20
10.5	Ø 3.35
13.5	Ø 3.60
21	Ø 4.40

# 3  
Ø 2.8 mm



**MD-06-148**  
15.5 cm

# 4	Diam.
0	Ø 3.10
7.5	Ø 3.70
10.5	Ø 3.90
15.5	Ø 4.30

# 4  
Ø 3.10 mm



**MD-06-149**  
15.5 cm

# 5	Diam.
0	Ø 3.90
10	Ø 5.00
13	Ø 5.20
20.5	Ø 6.30

# 5  
Ø 3.90 mm



**MD-06-150**  
15.5 cm

# 6	Diam.
0	Ø 5.50
10	Ø 6.20
13	Ø 6.30

# 6  
Ø 5.50 mm



**MD-06-151**  
15.5 cm

# 1	Diam.
0	Ø 1.50
5	Ø 1.90
8	Ø 2.20
10	Ø 2.40
12	Ø 2.60
14	Ø 2.80

# 1  
Ø 1.5 mm



**MD-06-152**  
15.5 cm

# 2	Diam.
0	Ø 2.10
5	Ø 2.60
8	Ø 2.80
10	Ø 3.00
12	Ø 3.20
14	Ø 3.40

# 2  
Ø 2.1 mm



**MD-06-153**  
15.5 cm

# 3	Diam.
0	Ø 2.60
5	Ø 3.00
8	Ø 3.30
10	Ø 3.50
12	Ø 3.70
14	Ø 3.90

# 3  
Ø 2.6 mm



**MD-06-154**  
15.5 cm

# 4	Diam.
0	Ø 3.00
5	Ø 3.50
8	Ø 3.80
10	Ø 4.00
12	Ø 4.20
14	Ø 4.40

# 4  
Ø 3.0 mm



**MD-06-155**  
15.5 cm

# 5	Diam.
0	Ø 3.50
5	Ø 3.90
8	Ø 4.20
10	Ø 4.40
12	Ø 4.60
14	Ø 4.80

# 5  
Ø 3.5 mm



**MD-06-156**  
15.5 cm

Ø 2.8 mm



**MD-06-157**  
15.5 cm

Ø 3.5 mm



**MD-06-158**  
15.5 cm

Ø 4.2 mm



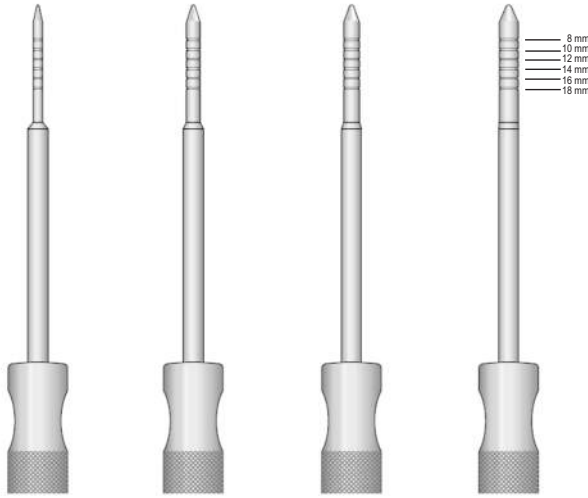
**MD-06-159**  
15.5 cm

Spelling Straight Bone Pusher



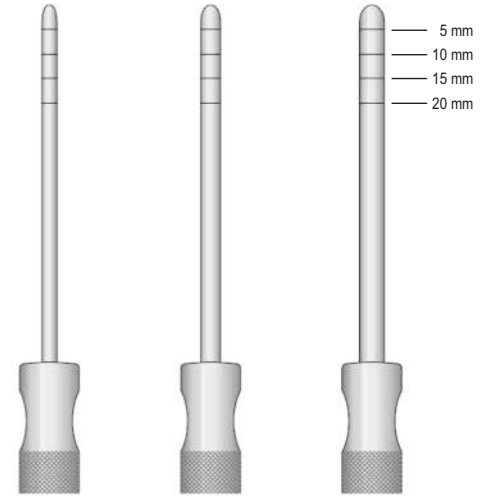
15 cm

Pointed  
 Ø 2 mm    Ø 3 mm    Ø 3.3 mm    Ø 4 mm



**MD-06-160** 15 cm  
**MD-06-161** 15 cm  
**MD-06-162** 15 cm  
**MD-06-163** 15 cm

Convex Tips  
 Ø 3 mm    Ø 4 mm    Ø 5 mm



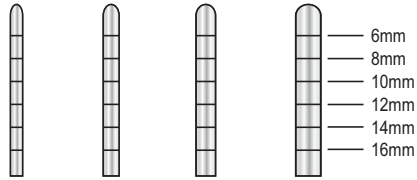
**MD-06-164** 15 cm  
**MD-06-165** 15 cm  
**MD-06-166** 15 cm

### Convex Tips



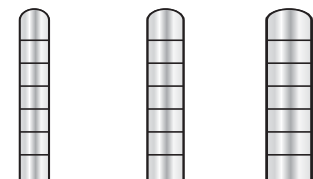
16.5 cm  
Str

Ø2.2mm    Ø2.5mm    Ø2.8mm    Ø3.1mm



**MD-06-167**    **MD-06-168**    **MD-06-169**    **MD-06-170**

Ø3.5mm    Ø3.8mm    Ø4.1mm

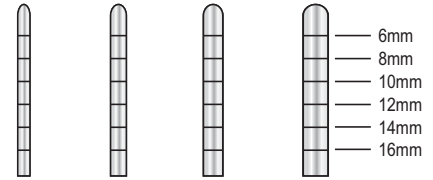


**MD-06-171**    **MD-06-172**    **MD-06-173**



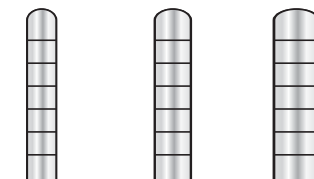
16.5 cm  
Cvd

Ø2.2mm    Ø2.5mm    Ø2.8mm    Ø3.1mm



**MD-06-174**    **MD-06-175**    **MD-06-176**    **MD-06-177**

Ø3.5mm    Ø3.8mm    Ø4.1mm



**MD-06-178**    **MD-06-179**    **MD-06-180**



IMPLANTOLOGY INSTRUMENTS

Osteotomes with Stop

Concave

Ø2mm Ø3mm Ø3.3mm Ø4mm

6mm 11mm 15mm

MD-06-181 MD-06-182 MD-06-183 MD-06-184

Convex

Ø2mm Ø3mm Ø3.3mm Ø4mm

6mm 11mm 15mm

MD-06-185 MD-06-186 MD-06-187 MD-06-188

Pointed

Ø2mm Ø3mm Ø3.3mm Ø4mm

6mm 11mm 15mm

MD-06-189 MD-06-190 MD-06-191 MD-06-192

16.5 cm Str

Concave

Ø2mm Ø3mm Ø3.3mm Ø4mm

6mm 11mm 15mm

MD-06-193 MD-06-194 MD-06-195 MD-06-196

Convex

Ø2mm Ø3mm Ø3.3mm Ø4mm

6mm 11mm 15mm

MD-06-197 MD-06-198 MD-06-199 MD-06-200

Pointed

Ø2mm Ø3mm Ø3.3mm Ø4mm

6mm 11mm 15mm

MD-06-201 MD-06-202 MD-06-203 MD-06-204

MD-06-200 16.5 cm Cvd

Concave

Ø2.5mm Ø3mm Ø3.8mm Ø4.5mm Ø5mm

8mm 11mm 13mm 15mm 17mm 20mm

MD-06-205 MD-06-206 MD-06-207 MD-06-208 MD-06-209

Convex

Ø2.5mm Ø3mm Ø3.8mm Ø4.5mm Ø5mm

8mm 11mm 13mm 15mm 17mm 20mm

60-314-16 60-315-16 60-316-16 60-317-16 60-318-16

Pointed

Ø2.5mm Ø3mm Ø3.8mm Ø4.5mm Ø5mm

8mm 11mm 13mm 15mm 17mm 20mm

60-319-16 60-320-16 60-321-16 60-322-16 60-323-16

16.5 cm Str

Concave

Ø2.5mm Ø3mm Ø3.8mm Ø4.5mm Ø5mm

8mm 11mm 13mm 15mm 17mm 20mm

MD-06-210 MD-06-211 MD-06-212 MD-06-213 MD-06-214

Convex

Ø2.5mm Ø3mm Ø3.8mm Ø4.5mm Ø5mm

8mm 11mm 13mm 15mm 17mm 20mm

MD-06-215 MD-06-216 MD-06-217 MD-06-218 MD-06-219

Pointed

Ø2.5mm Ø3mm Ø3.8mm Ø4.5mm Ø5mm

8mm 11mm 13mm 15mm 17mm 20mm

MD-06-220 MD-06-221 MD-06-222 MD-06-223 MD-06-224

16.5 cm Cvd



### Trephine Drills



**MD-06-225**  
Interior 2 mm  
Exterior 3 mm

**MD-06-226**  
Interior 3 mm  
Exterior 4 mm

**MD-06-227**  
Interior 4 mm  
Exterior 5 mm

**MD-06-228**  
Interior 5 mm  
Exterior 6 mm

**MD-06-229**  
Interior 6 mm  
Exterior 7 mm

**MD-06-230**  
Interior 7 mm  
Exterior 8 mm

**MD-06-231**  
Interior 8 mm  
Exterior 9 mm

**MD-06-232**  
Interior 9 mm  
Exterior 10 mm



**MD-06-233**  
Trephine Drills Stand  
Complete with drills



**MD-06-234**  
Trephine Drills Stand  
Complete with drills

### Tissue Punches



**MD-06-235**  
3 mm

**MD-06-236**  
4 mm

**MD-06-237**  
5 mm

**MD-06-238**  
8 mm

Keys



**MD-06-239**  
3 mm

**MD-06-240**  
4 mm

**MD-06-241**  
5 mm

**MD-06-242**  
6 mm

Keys

## IMPLANTOLOGY INSTRUMENTS

### Bone Thickness Gauges



Fig. 1  
Castroviejo  
MD-06-243



Fig. 2  
Castroviejo  
MD-06-244



Fig. 3  
Castroviejo  
MD-06-245



Fig. 4  
Castroviejo  
MD-06-246



Fig. 5  
Castroviejo  
MD-06-247



MD-06-248  
Bone Thickness Gauge



MD-06-249  
Bone Caliper  
15 cm



60-371-00  
Sinus Rongeur  
Delicate bone cutting forcep  
for opening the sinus window  
4 mm bite, TiN coated

### Bone Injectors



Fig. 1  
MD-06-250



Fig. 2  
MD-06-251



Fig. 3  
MD-06-252

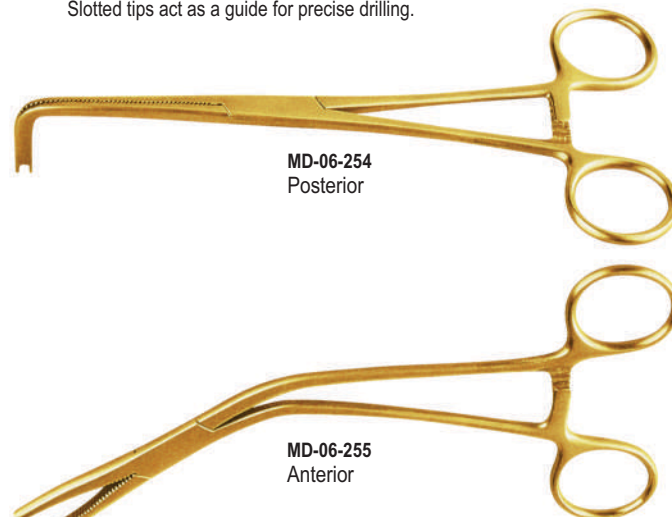


Fig. 4  
MD-06-253



### TiN coated bone block clamps

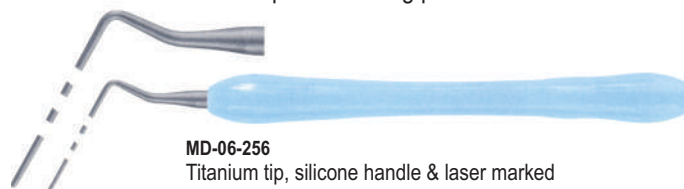
To hold & stabilize block graft against recipient site while placing screws.  
Slotted tips act as a guide for precise drilling.



MD-06-254  
Posterior

MD-06-255  
Anterior

### Depth measuring probes



MD-06-256  
Titanium tip, silicone handle & laser marked



PERIOSTEAL ELEVATORS & PERIODONTAL INSTRUMENTS

Titanium implant periosteal elevators



Fig. 1 MD-06-257 Busar Blue



Fig. 3 MD-06-258 Prichard Blue

Implant periosteal elevators



Fig. 1 MD-06-259 Busar



Fig. 9A MD-06-260 Allen



Fig. 25 MD-06-261 17 cm

Gingivectomy Knives

Hollow handle

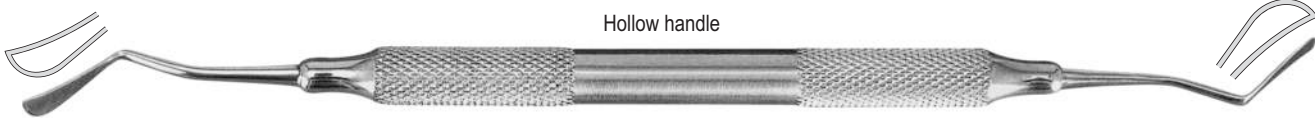


Fig. 15/16 MD-06-262 Kirkland



Fig. 1/2 MD-06-263 Orban

Solid handle

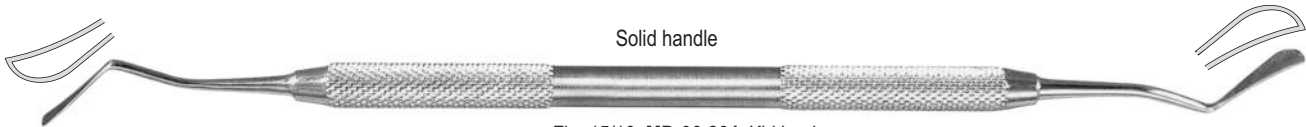


Fig. 15/16 MD-06-264 Kirkland

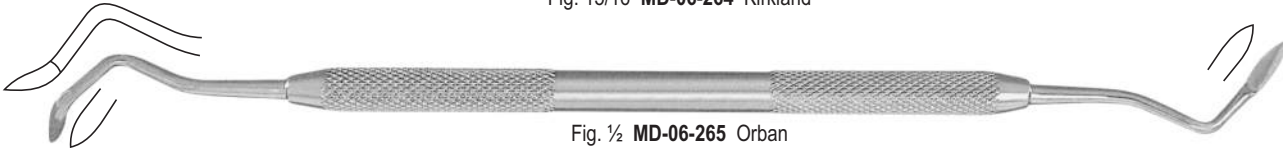


Fig. 1/2 MD-06-265 Orban



Fig. 1 MD-06-266 Orban



Fig. 2 60-382-02 Orban



BONE CURETTES

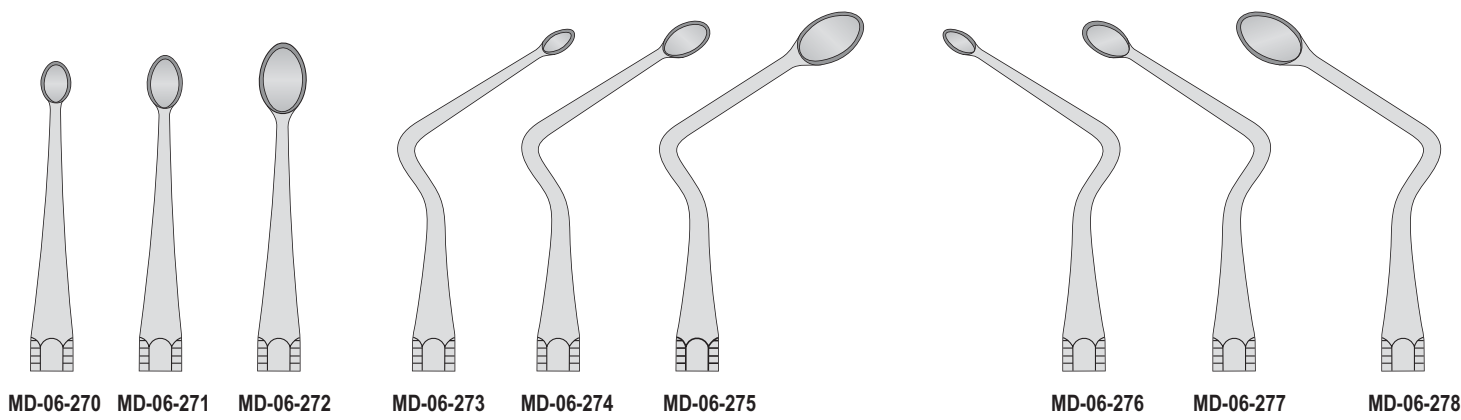
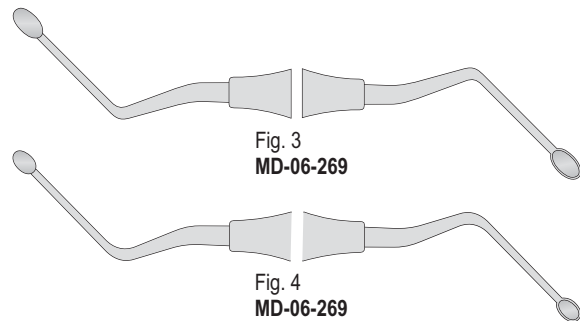
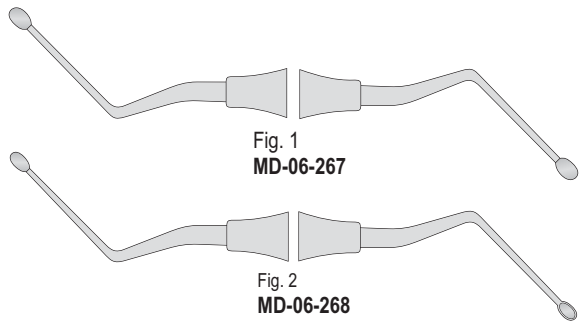
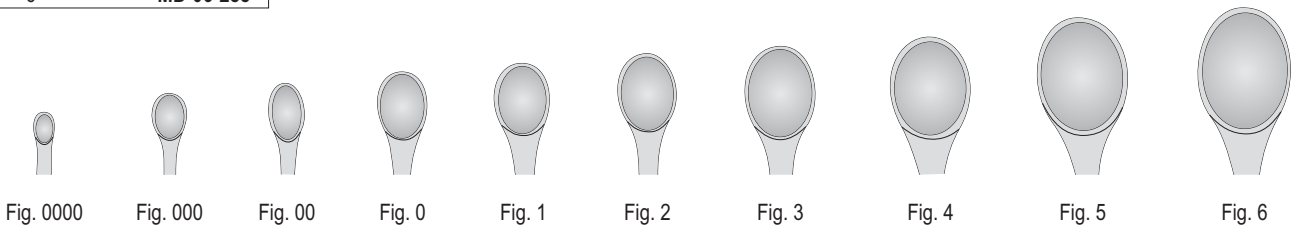
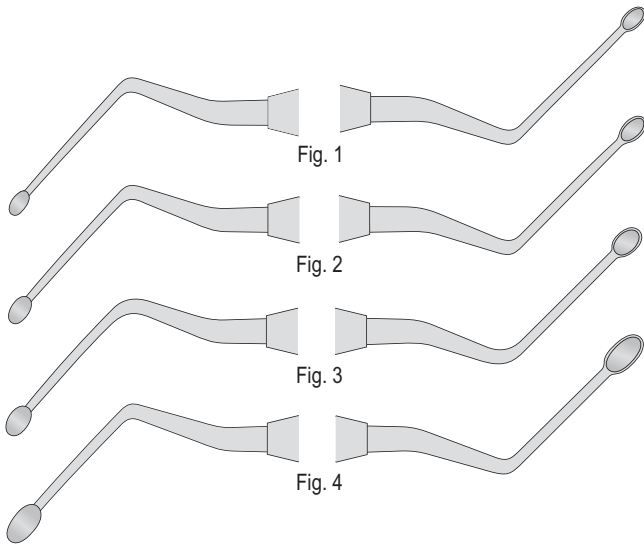
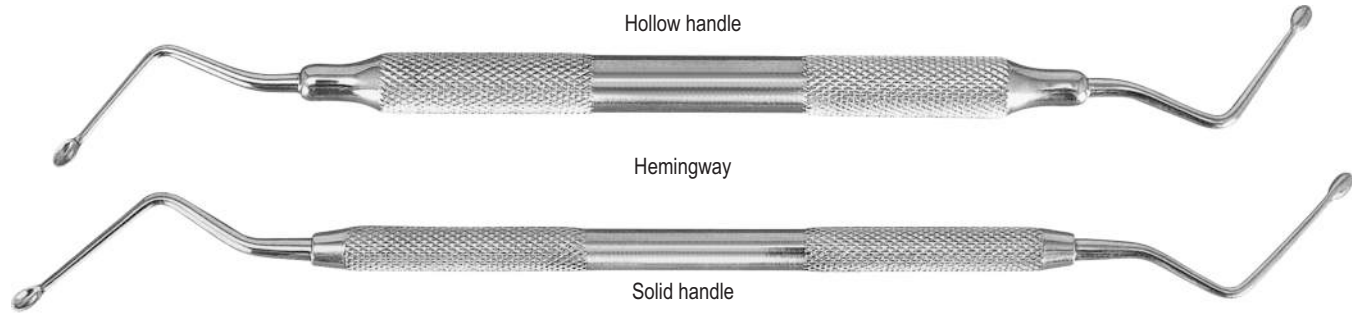
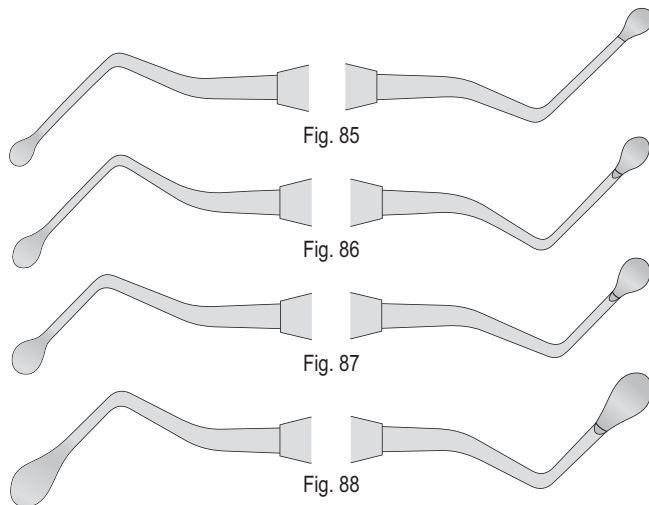
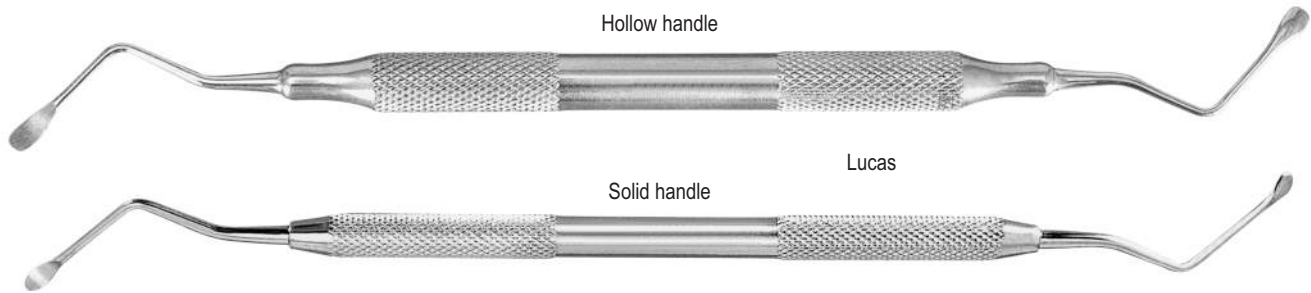


Fig.	Volkman
0000	MD-06-279
000	MD-06-280
00	MD-06-281
0	MD-06-282
1	MD-06-283
2	MD-06-284
3	MD-06-285
4	MD-06-286
5	MD-06-287
6	MD-06-288





	Solid handle	Hollow handle
Fig. 1	<b>MD-06-290</b>	<b>MD-06-294</b>
Fig. 2	<b>MD-06-291</b>	<b>MD-06-295</b>
Fig. 3	<b>MD-06-292</b>	<b>MD-06-296</b>
Fig. 4	<b>MD-06-293</b>	<b>MD-06-297</b>

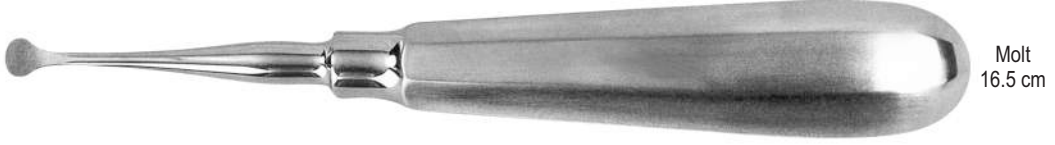


	Solid handle	Hollow handle
Fig. 85	<b>MD-06-298</b>	<b>MD-06-302</b>
Fig. 86	<b>MD-06-299</b>	<b>MD-06-303</b>
Fig. 87	<b>MD-06-300</b>	<b>MD-06-304</b>
Fig. 88	<b>MD-06-301</b>	<b>MD-06-305</b>



BONE CURETTES & FILES

Bone curettes



Molt  
16.5 cm



Fig. 1  
MD-06-306



Fig. 2  
MD-06-307



Fig. 4  
MD-06-308

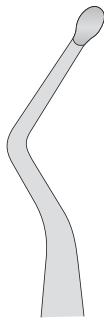


Fig. 5  
MD-06-309



Fig. 6  
MD-06-310

Bone Files



Williger  
14 cm



Fig. 00/0  
MD-06-311



Fig. 0/1  
MD-06-312



Fig. 1/2  
MD-06-313



Fig. 10  
MD-06-314



Fig. 12A  
MD-06-315

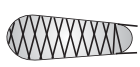


Fig. 33  
MD-06-316



Fig. 12  
MD-06-317  
Howard



Fig. 45  
MD-06-318  
Miller

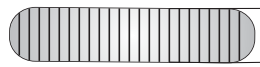
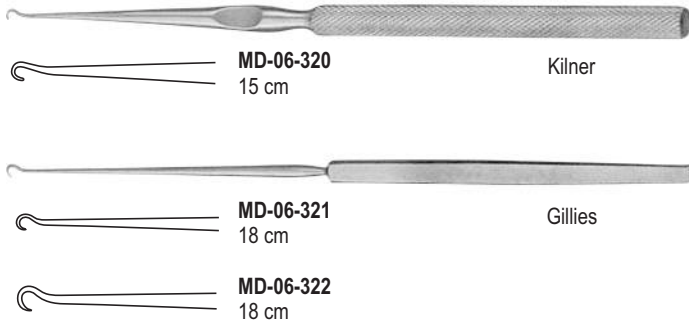


Fig. 64  
MD-06-319  
Miller



### Skin Hooks

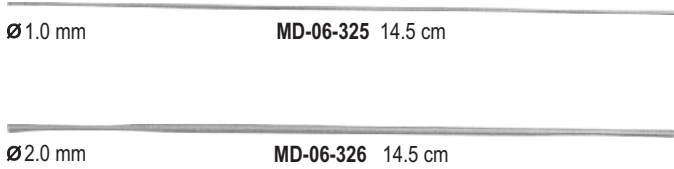


**MD-06-320** Kilner  
15 cm

**MD-06-321** Gillies  
18 cm

**MD-06-322** Gillies  
18 cm

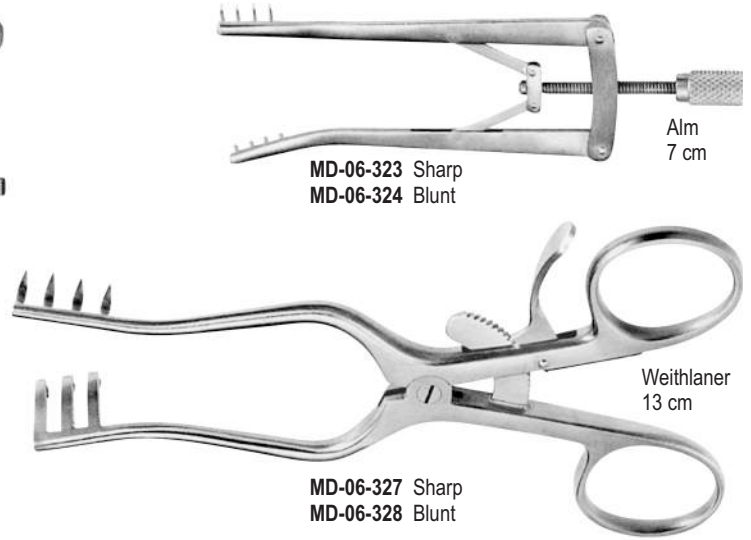
### Probes



$\varnothing$  1.0 mm **MD-06-325** 14.5 cm

$\varnothing$  2.0 mm **MD-06-326** 14.5 cm

### Self-Retaining Retractors



**MD-06-323** Sharp  
**MD-06-324** Blunt

Alm  
7 cm

Weithlaner  
13 cm

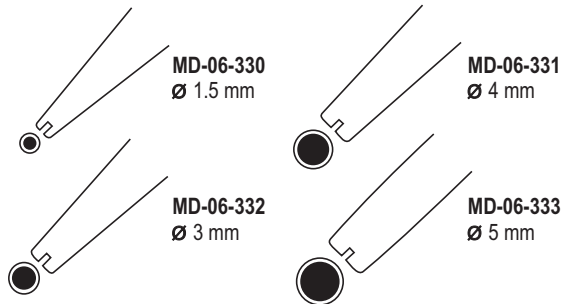
**MD-06-327** Sharp  
**MD-06-328** Blunt

### Suture Forceps



**MD-06-329**  
16 cm

### Suction Tubes



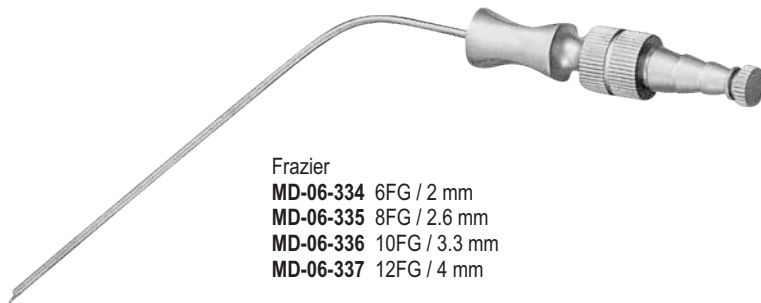
**MD-06-330**  
 $\varnothing$  1.5 mm

**MD-06-331**  
 $\varnothing$  4 mm

**MD-06-332**  
 $\varnothing$  3 mm

**MD-06-333**  
 $\varnothing$  5 mm

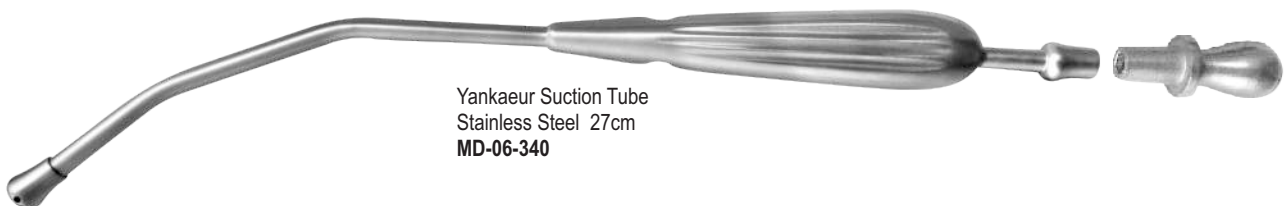
suction tubes have notch at working end to prevent premature suction.



Frazier  
**MD-06-334** 6FG / 2 mm  
**MD-06-335** 8FG / 2.6 mm  
**MD-06-336** 10FG / 3.3 mm  
**MD-06-337** 12FG / 4 mm



Ladmore  
**MD-06-338** Small  
**MD-06-339** Large



Yankaeur Suction Tube  
Stainless Steel 27cm  
**MD-06-340**

**MALLEABLE & DUCTILE**  
INSTRUMENTS

07

Page 88-129

**Mirror Handles, Scalars  
& Knives**

Mouth Mirror & Mirror Handles  
Scaler Handles  
Scalpel Blades & Handles  
Micro Scalpel Handles & Blades  
Explorers Double Ended  
Explorers Single Ended  
Probes Single Ended  
Gracey Curettes  
Periodontal Instruments  
Scalers  
Endodontic Instruments  
Filling Instruments  
Cavity Preparation Tips & Amalgam Instruments  
Amalgam Pluggers  
Burnishers  
Composite / Plastic Filling Instruments  
Excavators  
Carvers & Finishing Knives  
Finishing Knives & Cleoid-Discoid  
Wax Modelling Carvers  
Cement Spatulae & Glass Mixing Slabs  
Plaster Knives - Alginate & Plaster Spatulae  
Wax Knives







## MOUTH MIRROR & MIRROR HANDLES



Fig. 4  
MD-07-001  
Ø 22 mm

Fig. 5  
MD-07-002  
Ø 24 mm

Fig. 000  
MD-07-003  
Ø 10 mm

Fig. 00  
MD-07-004  
Ø 12 mm

- Rhodium coated front surface mirror
- Wide stem offers comfortable cheek retraction
- Non glare satin finish

Micro mirrors  
Rhodium front surface

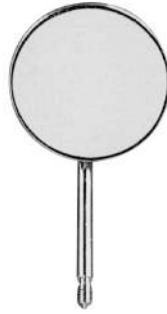


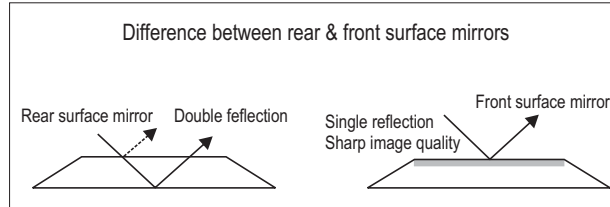
Fig. 2  
18 mm

Fig. 3  
20 mm

Fig. 4  
22 mm

Fig. 5  
24 mm

Fig.	Ø mm	Pack of 12			
		Front surface		Rear surface	
		Rhodium	Chrome	Magnifying	Plane
2	18	MD-07-005	-	MD-07-011	MD-07-015
3	20	MD-07-006	-	MD-07-012	MD-07-016
4	22	MD-07-007	MD-07-009	MD-07-013	MD-07-017
5	24	MD-07-008	MD-07-010	MD-07-014	MD-07-018



### Mirror handles solid

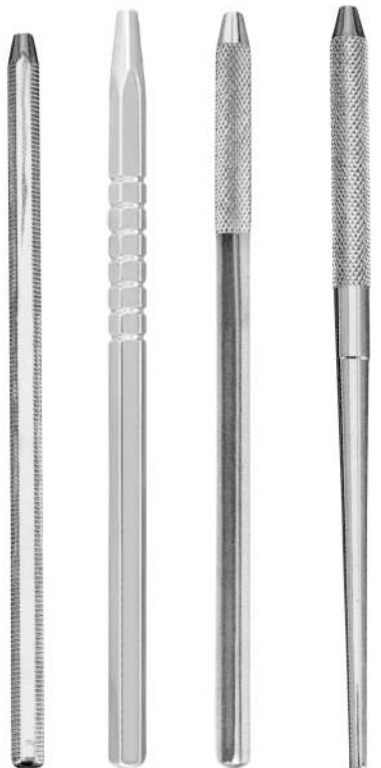


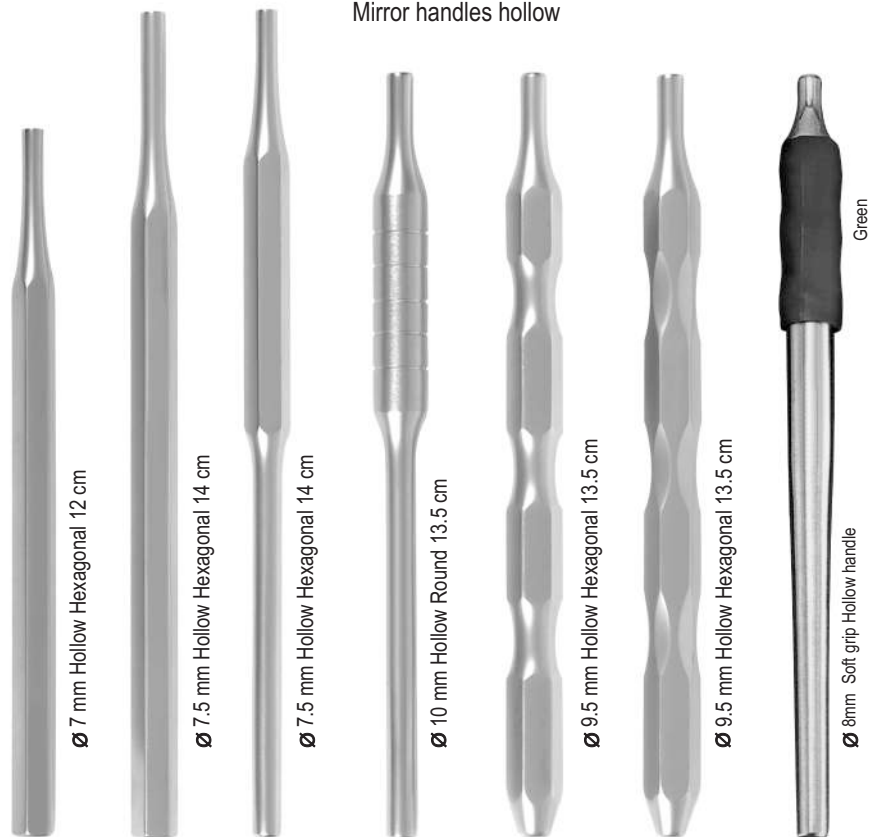
Fig. 1  
MD-07-019

Fig. 2  
MD-07-020

Fig. 3  
MD-07-021

Fig. 4  
MD-07-022

### Mirror handles hollow



Ø 7 mm Hollow Hexagonal 12 cm

Ø 7.5 mm Hollow Hexagonal 14 cm

Ø 7.5 mm Hollow Hexagonal 14 cm

Ø 10 mm Hollow Round 13.5 cm

Ø 9.5 mm Hollow Hexagonal 13.5 cm

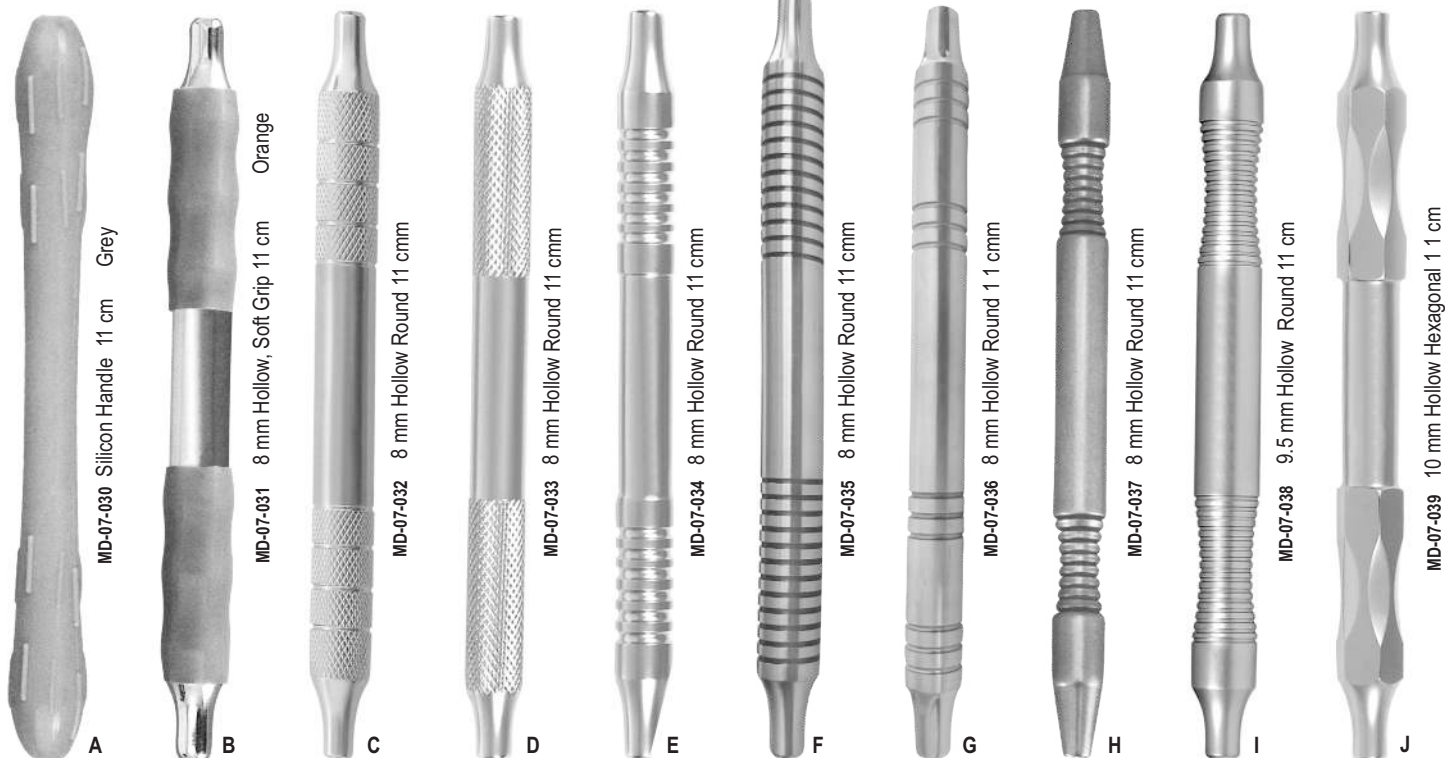
Ø 9.5 mm Hollow Hexagonal 13.5 cm

Ø 8mm Soft grip Hollow handle

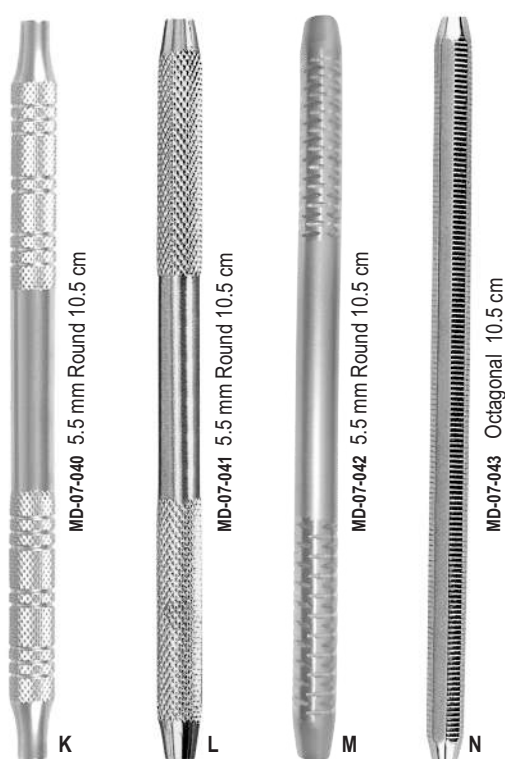
Green

## SCALER HANDLES CHOICE

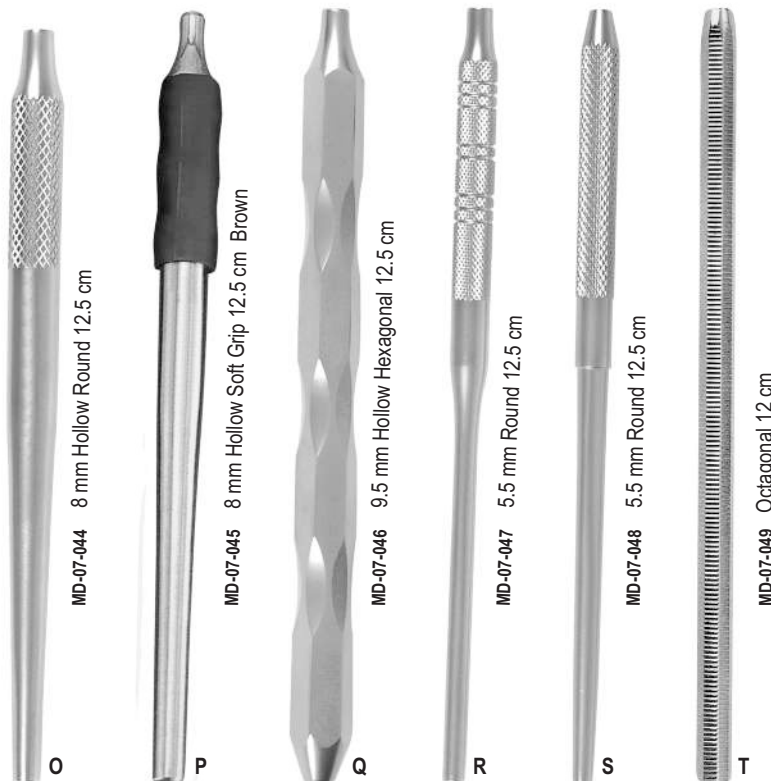
### Double Ended



### Double Ended



### Single Ended





- Sterile
- Individually Packed
- Box of 100 Pieces



Fig. 10 MD-07-050    Fig. 11 MD-07-051    Fig. 12 MD-07-052    Fig. 12D MD-07-053    Fig. 13 MD-07-054    Fig. 15 MD-07-055    Fig. 15C MD-07-056    Fig. 20 MD-07-057    Fig. 21 MD-07-058    Fig. 22 MD-07-059    Fig. 23 MD-07-060    Fig. 24 MD-07-061    Fig. 25 MD-07-062



For scalpel No. 10, 11, 12, 12D, 13, 15, 15C

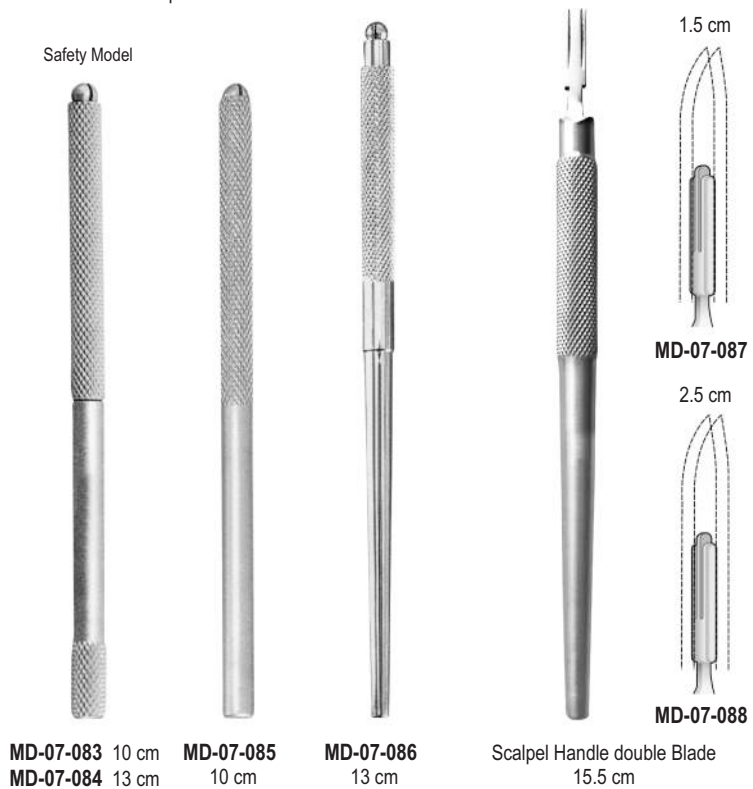
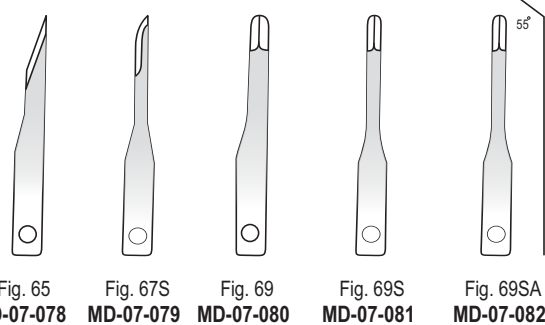
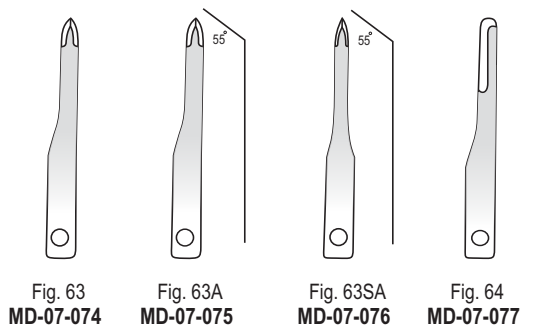
For Blades No. 20, 21, 22, 23, 24, 25

Fig. 3 MD-07-063    Fig. 3G MD-07-064    Fig. 4 MD-07-065    Fig. 3L MD-07-066    Fig. 7K MD-07-067    Fig. 7 MD-07-068    50-130-01 MD-07-069    Fig. 5S MD-07-070    Fig. 5A MD-07-071    Fig. 5 MD-07-072    Fig. 5 MD-07-073

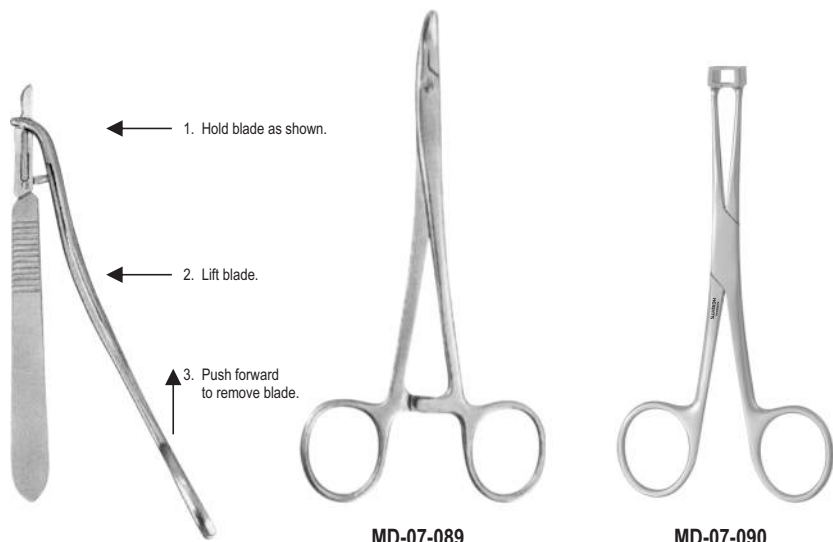
Red

MICRO SCALPEL HANDLES & BLADES

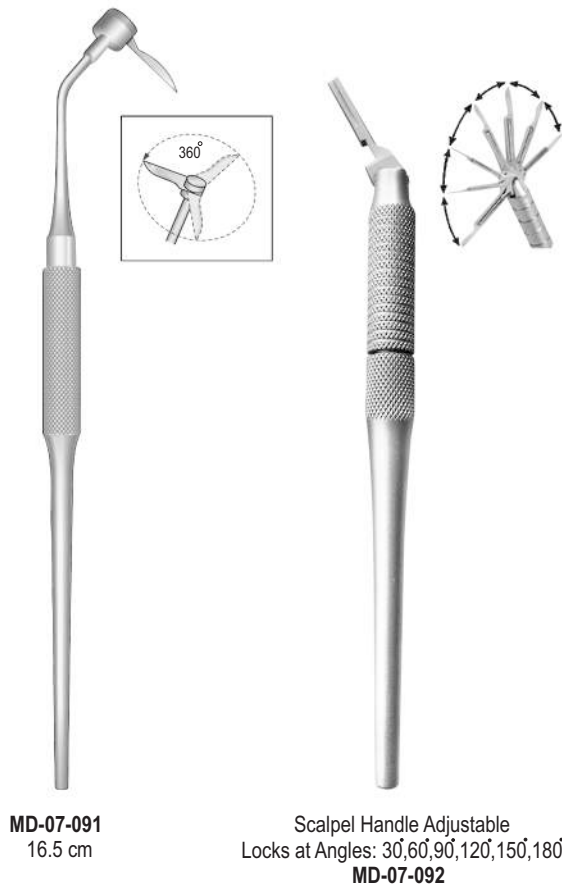
Micro scalpel & micro mirror handles



Scalpel Blade removing Forceps



1. Hold blade as shown.
2. Lift blade.
3. Push forward to remove blade.



Scalpel Handle Adjustable  
 Locks at Angles: 30°, 60°, 90°, 120°, 150°, 180°  
**MD-07-092**

Explorers double ended rigid



Fig. 23/17 MD-07-093



Fig. 23/17A MD-07-094

Explorers double ended rigid



Fig. 23/17 MD-07-094



Fig. 23/17A MD-07-095



Fig. 23/16 MD-07-096

Explorers double ended Flexible



Fig. 2 MD-07-097



Fig. 3 MD-07-098



Fig. 5 MD-07-099



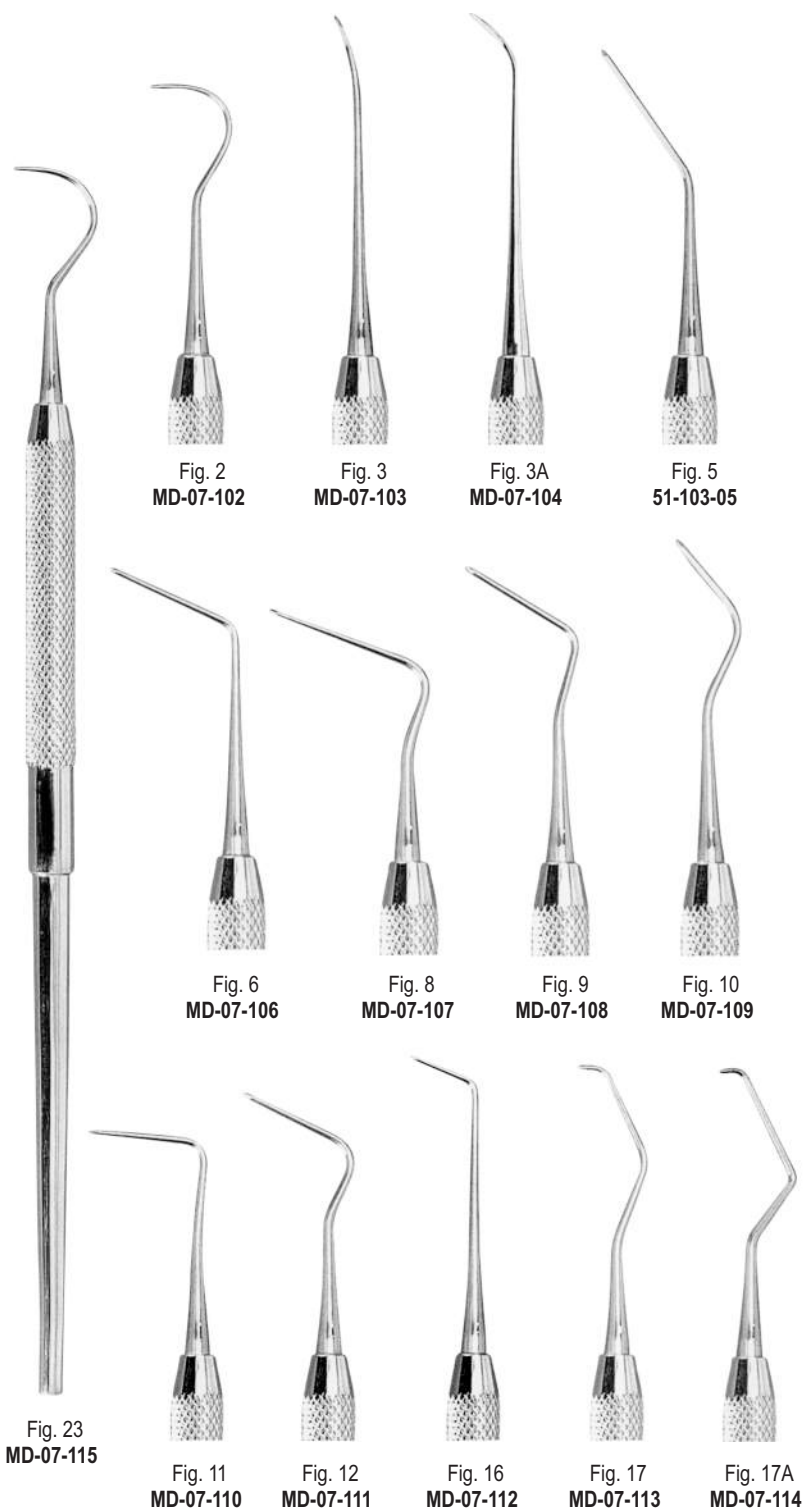
Fig. TU17/23 MD-07-100



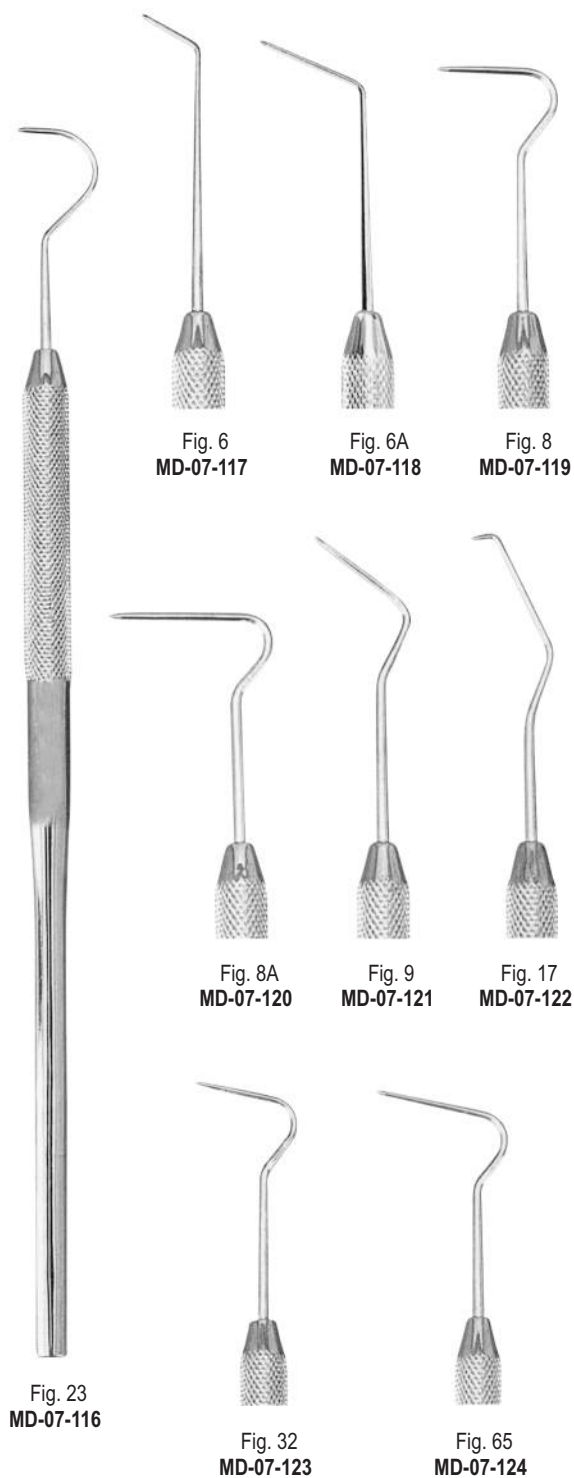
Fig. 6/23 MD-07-101

EXPLORERS SINGLE ENDED

Explorers single ended rigid

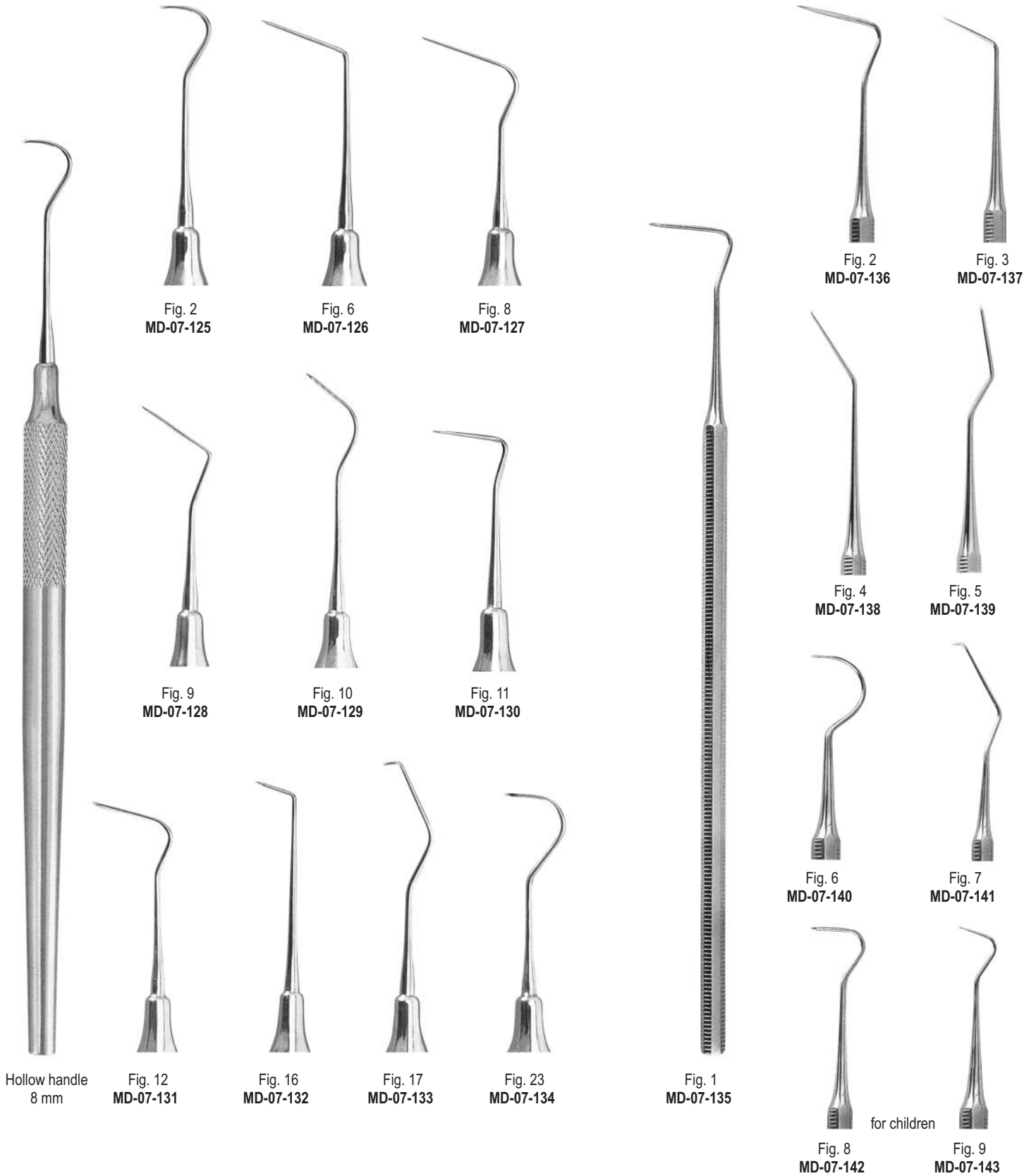


Explorers single ended flexible



Explorers single ended rigid

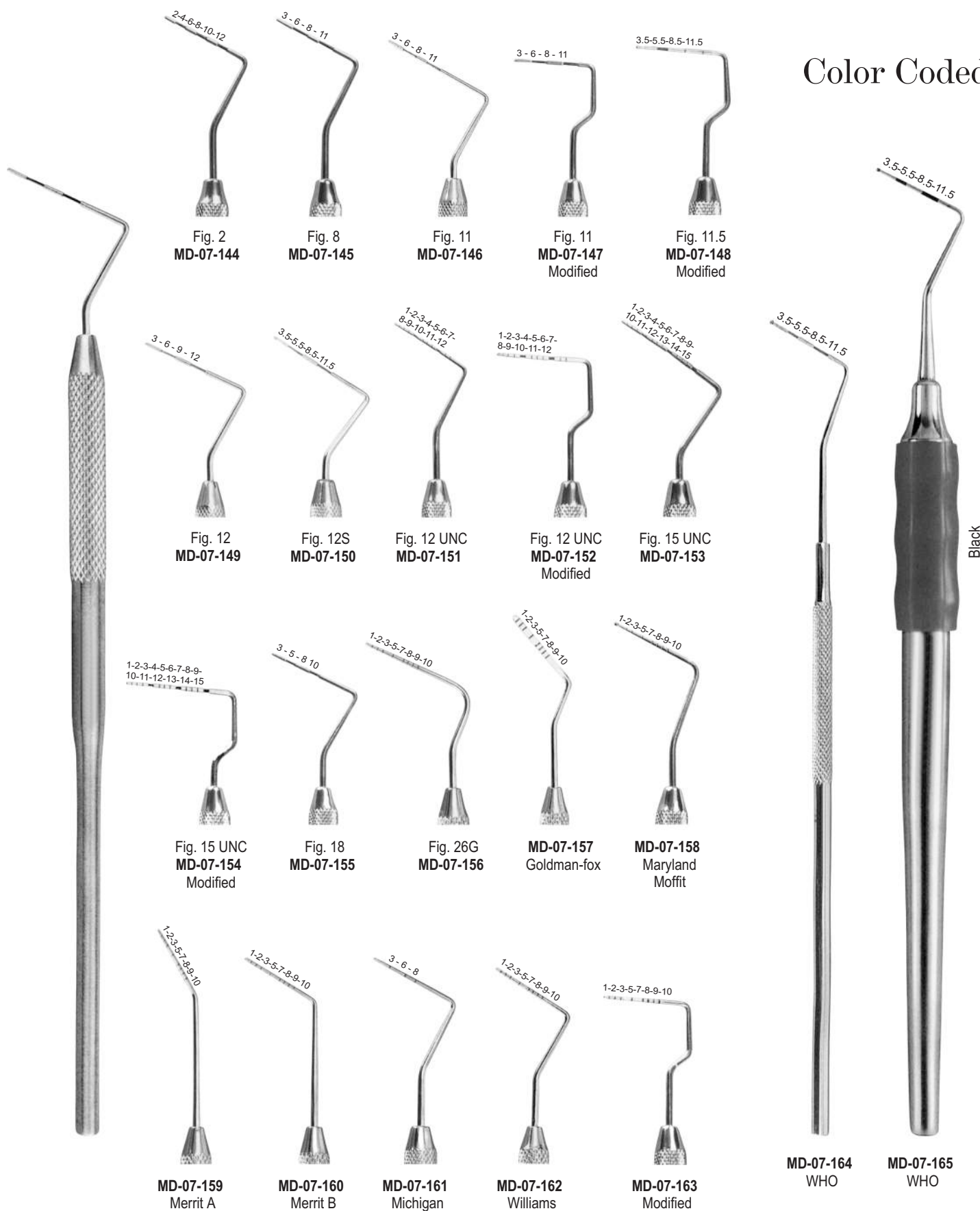
Explorers single ended rigid





PROBES SINGLE ENDED

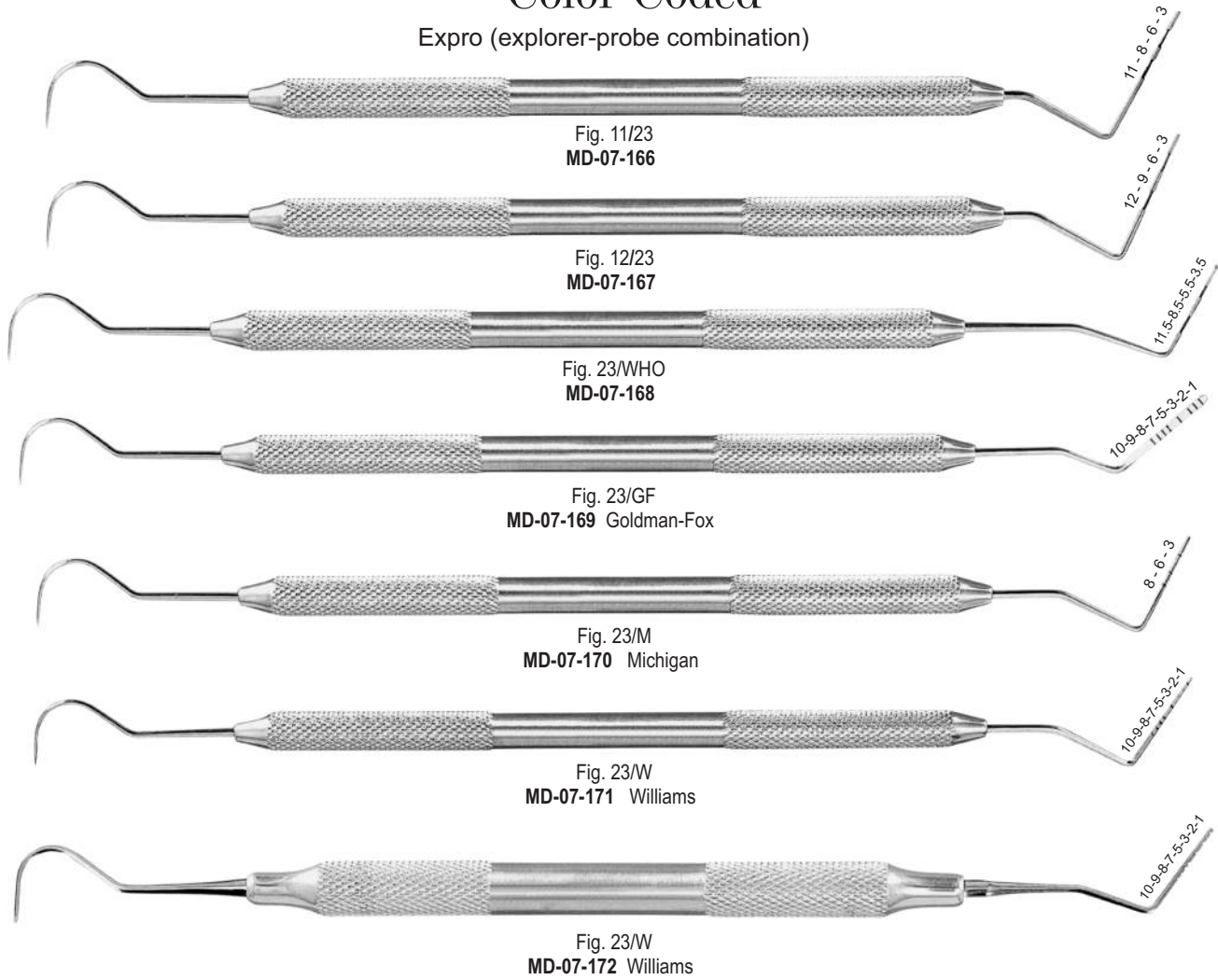
Color Coded



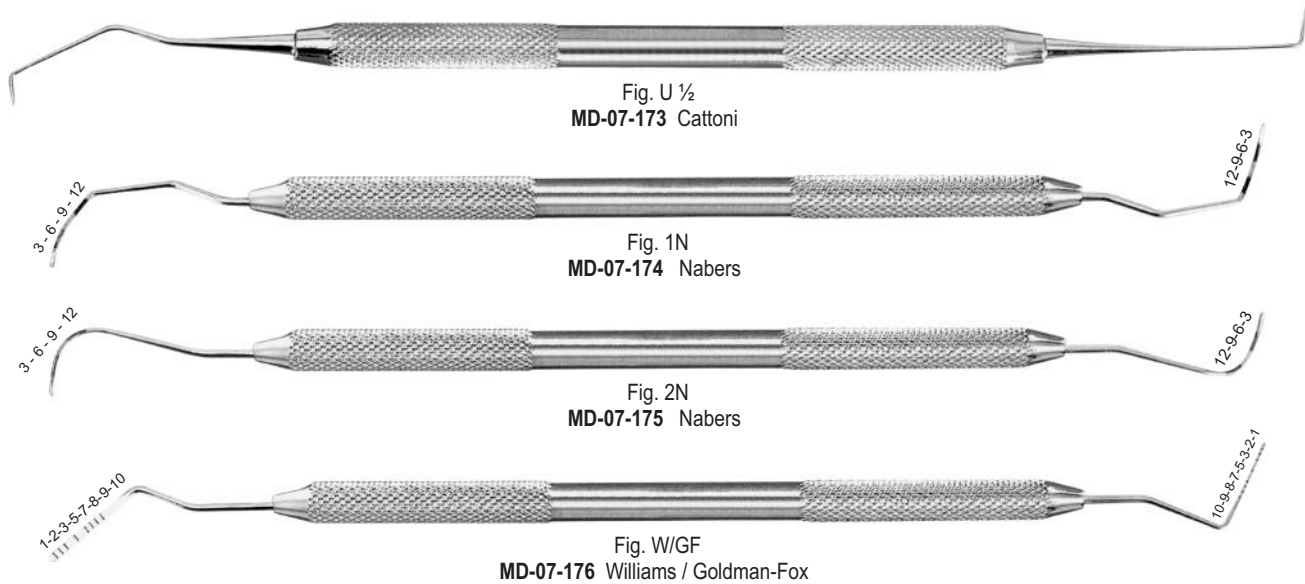


## Color Coded

Expro (explorer-probe combination)

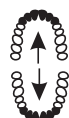


## Probes double ended



## GRACEY CURETTES

- Ergonomic, large diameter silicone handle for better grip
- Ultra light weight
- Special grade stainless steel tips ensure longer life
- Rigid pattern, thicker tips than standard Gracey

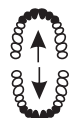


Anterior teeth



Grey

Fig. 1/2  
MD-07-177 Rigid  
MD-07-185 Standard

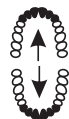


Anterior teeth



Black

Fig. 3/4  
MD-07-178 Rigid  
MD-07-186 Standard



Anterior and Premolars



Yellow

Fig. 5/6  
MD-07-179 Rigid  
MD-07-187 Standard



Premolars and Molars



Green

Fig. 7/8  
MD-07-180 Rigid  
MD-07-188 Standard



Molars buccal and lingual surfaces



Red

Fig. 9/10  
MD-07-181 Rigid  
MD-07-189 Standard



Posterior Mesial surfaces



Orange

Fig. 11/12  
MD-07-182 Rigid  
MD-07-190 Standard



Posterior distal surfaces



Blue

Fig. 13/14  
MD-07-183 Rigid  
MD-07-191 Standard

MD-07-177  
Set of 7 pieces / Rigid

MD-07-184  
Set of 7 pieces / Standard



Fig. ½  
MD-07-192  
Green  
Anterior teeth



Fig. 3/4  
MD-07-193  
Black  
Anterior teeth



Fig. 5/6  
MD-07-194  
Yellow  
Anterior and Premolars



Fig. 7/8  
MD-07-195  
Grey  
Premolars and Molars



Fig. 9/10  
MD-07-196  
Red  
Molars buccal and lingual surfaces



Fig. 11/12  
MD-07-197  
Orange  
Posterior mesial surfaces



Fig. 13/14  
MD-07-198  
Blue  
Posterior distal surfaces

MD-07-199  
Set of 7 pieces  
Fig. 1/2, 3/4, 5/6, 7/8, 9/10, 11/12, 13/14



Fig. 15/16  
MD-07-200  
Coffee  
Posterior mesial surfaces

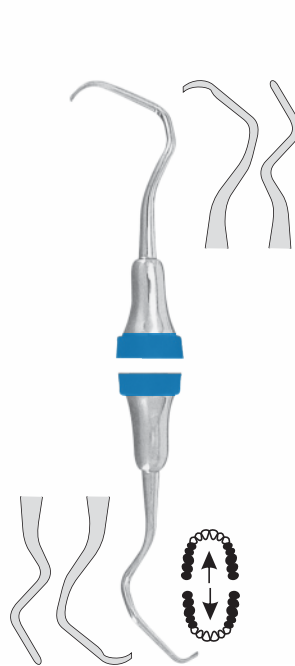


Fig. 17/18  
MD-07-201  
Light Blue  
Posterior distal surfaces

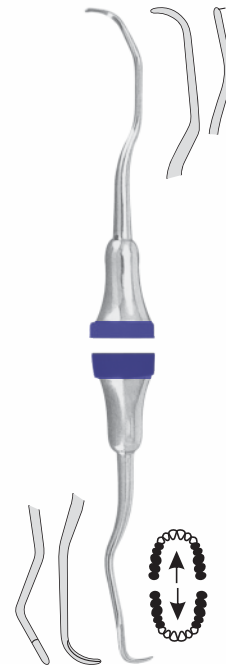


Fig. 11/14  
MD-07-202  
Blue  
Mesial/Distal surfaces

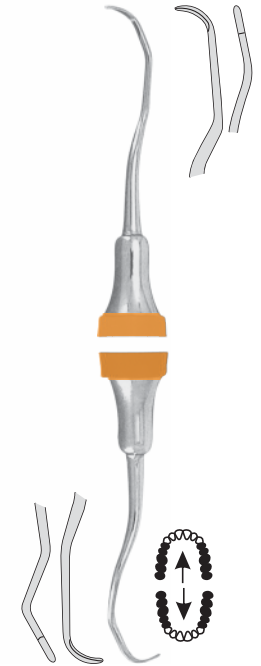


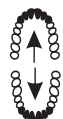
Fig. 12/13  
MD-07-203  
Orange  
Mesial/Distal surfaces

GRACEY CURETTES

Solid handle



Hollow handle



Anterior teeth

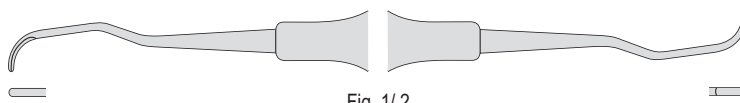
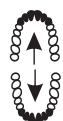


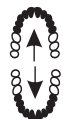
Fig. 1/2



Anterior teeth



Fig. 3/4



Anterior and  
Premolars

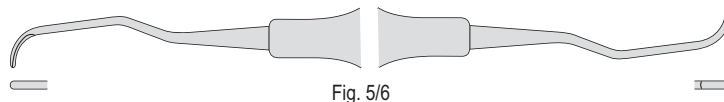


Fig. 5/6



Premolars and  
Molars

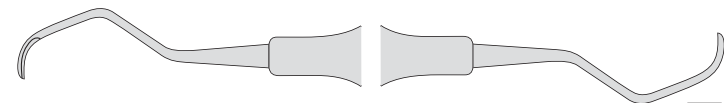
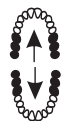


Fig. 7/8



Molars buccal and  
lingual surfaces

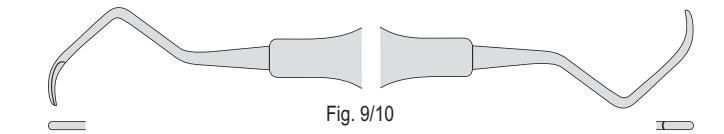


Fig. 9/10



Posterior mesial  
surfaces

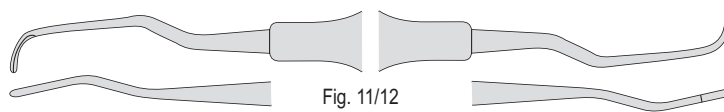


Fig. 11/12



Posterior distal  
surfaces

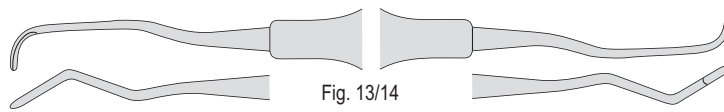


Fig. 13/14

Solid handle

Fig. 1/2	<b>MD-07-204</b>
Fig. 3/4	<b>MD-07-205</b>
Fig. 5/6	<b>MD-07-206</b>
Fig. 7/8	<b>MD-07-207</b>
Fig. 9/10	<b>MD-07-208</b>
Fig. 11/12	<b>MD-07-209</b>
Fig. 13/14	<b>MD-07-210</b>

**MD-07-211**

Gracey set of 7 pieces

Hollow handle

Fig. 1/2	<b>MD-07-212</b>
Fig. 3/4	<b>MD-07-213</b>
Fig. 5/6	<b>MD-07-214</b>
Fig. 7/8	<b>MD-07-215</b>
Fig. 9/10	<b>MD-07-216</b>
Fig. 11/12	<b>MD-07-217</b>
Fig. 13/14	<b>MD-07-218</b>

**MD-07-219**

Gracey set of 7 pieces

Periodontal chisels



Fig. 1 MD-07-220 TG



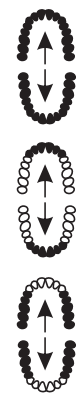
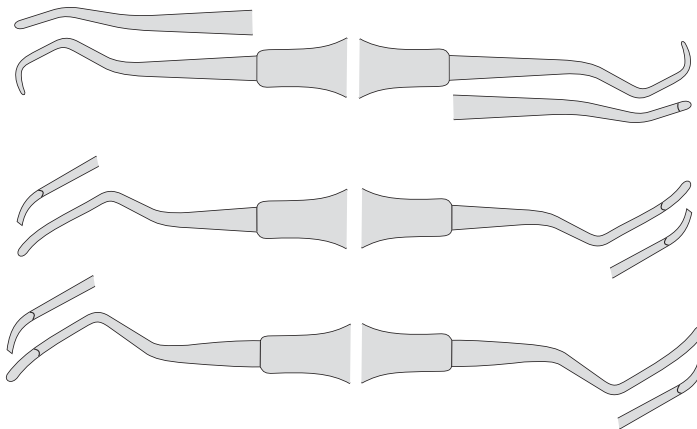
Fig. 2 MD-07-221 TG

Universal Curettes Columbia

Solid handle



Hollow handle



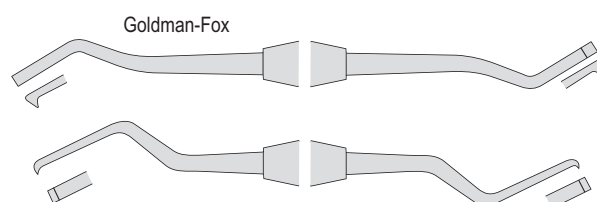
			Solid handle	Hollow handle
Universal	Fig. 13/14	MD-07-222	MD-07-223	
Anterior teeth	Fig. 2R/2L	MD-07-224	MD-07-225	
Posterior teeth	Fig. 4R/4L	MD-07-226	MD-07-227	

Hoe scalars

Solid handle

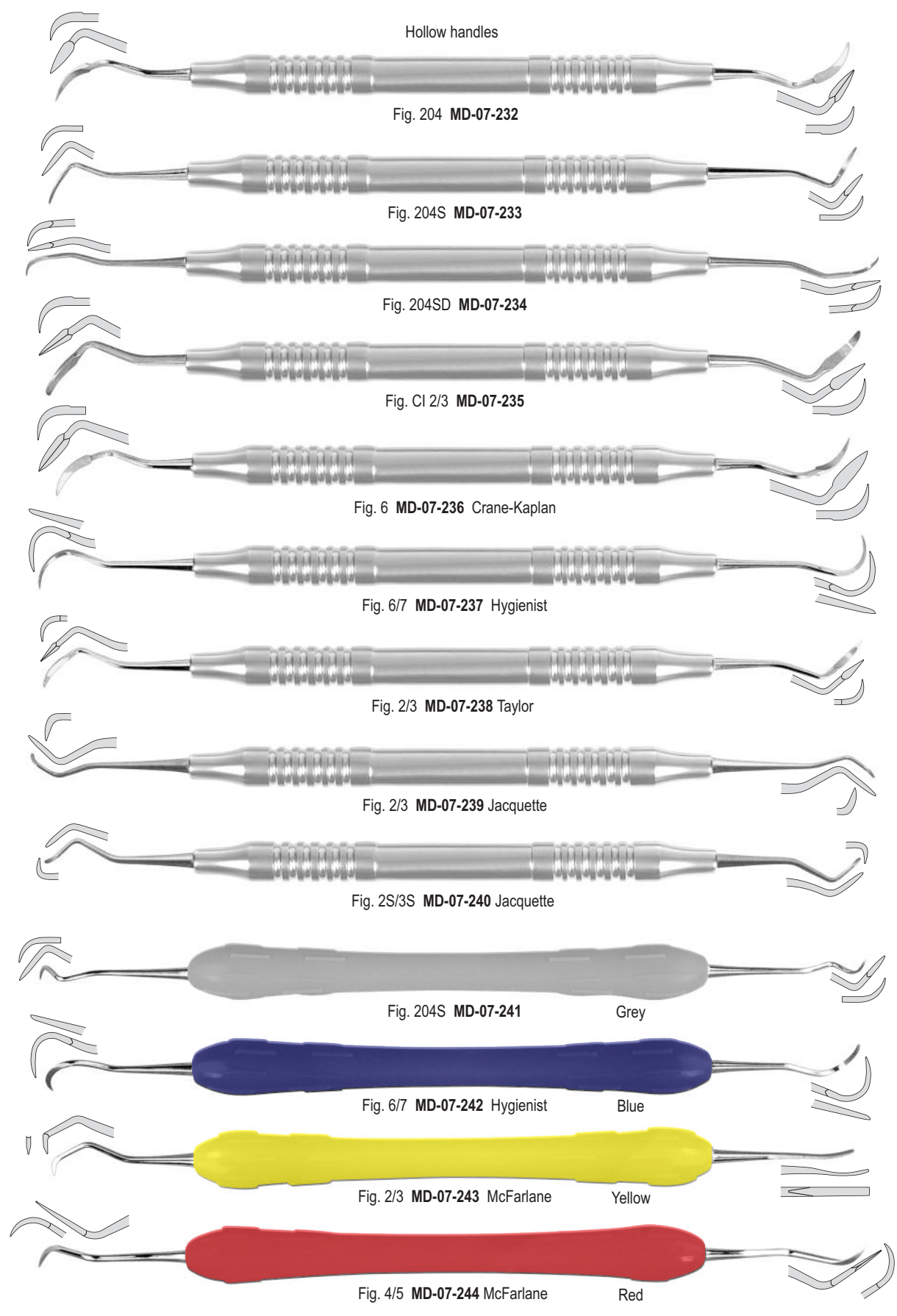


Hollow handle



		Solid handle	Hollow handle
Goldman-Fox	Fig. 5	MD-07-227	MD-07-229
	Fig. 6	MD-07-230	MD-07-231

SCALERS



Solid handle

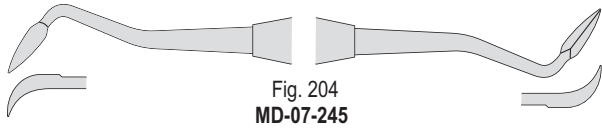


Fig. 204  
MD-07-245

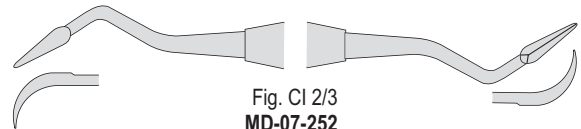


Fig. Cl 2/3  
MD-07-252

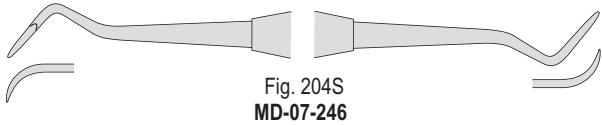


Fig. 204S  
MD-07-246

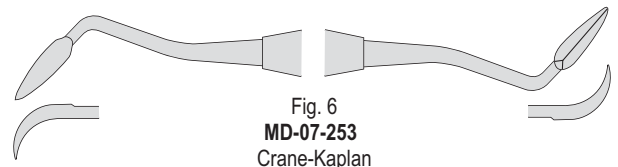


Fig. 6  
MD-07-253  
Crane-Kaplan

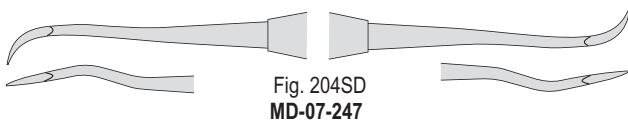


Fig. 204SD  
MD-07-247

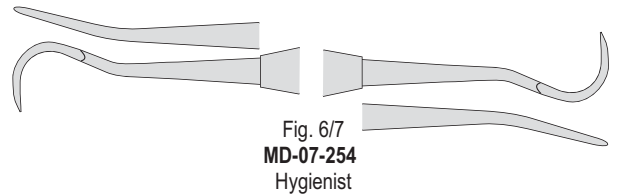


Fig. 6/7  
MD-07-254  
Hygienist

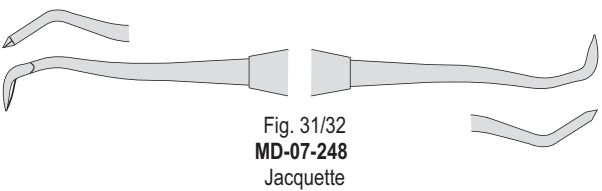


Fig. 31/32  
MD-07-248  
Jacquette

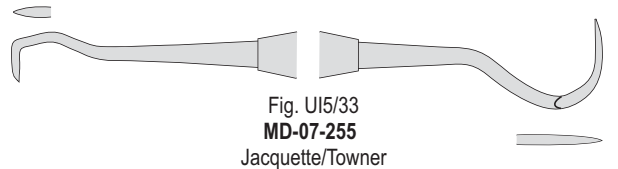


Fig. U15/33  
MD-07-255  
Jacquette/Towner

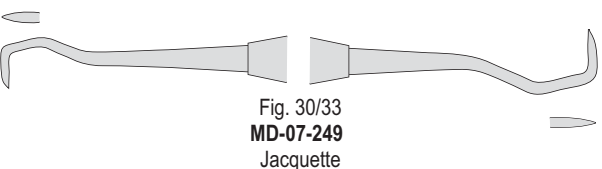


Fig. 30/33  
MD-07-249  
Jacquette

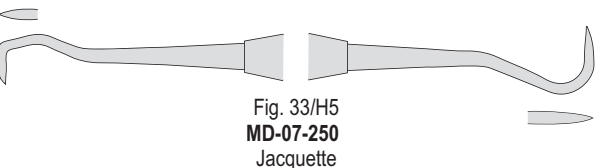


Fig. 33/H5  
MD-07-250  
Jacquette

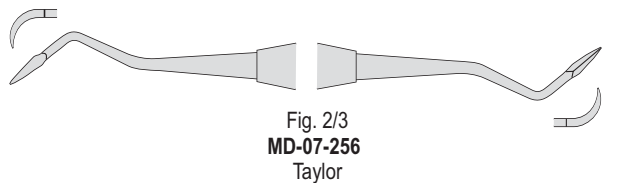


Fig. 2/3  
MD-07-256  
Taylor

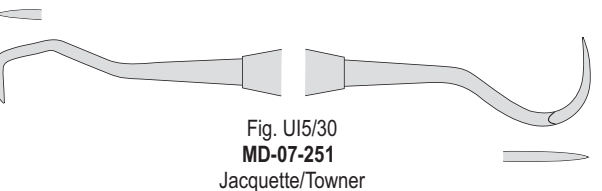


Fig. U15/30  
MD-07-251  
Jacquette/Towner

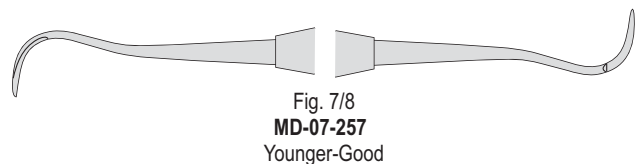


Fig. 7/8  
MD-07-257  
Younger-Good

SCALERS DOUBLE ENDED

Hollow handle

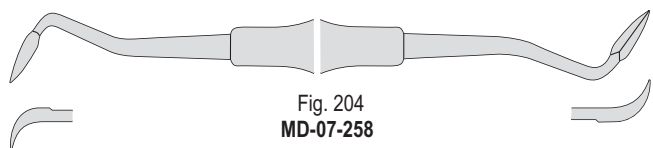
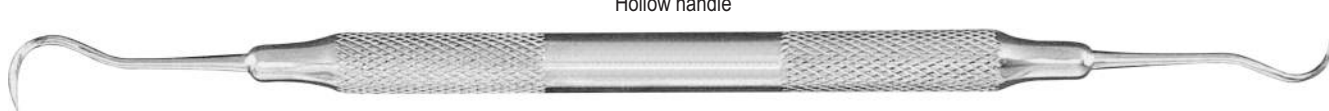


Fig. 204  
**MD-07-258**

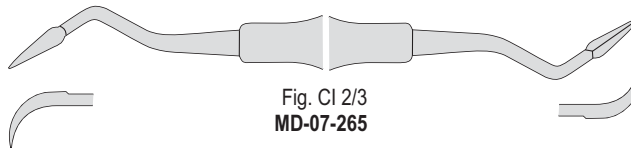


Fig. CI 2/3  
**MD-07-265**

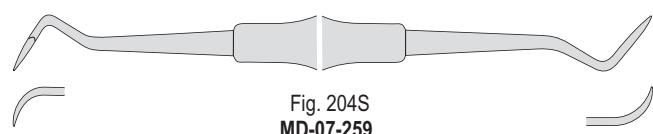


Fig. 204S  
**MD-07-259**

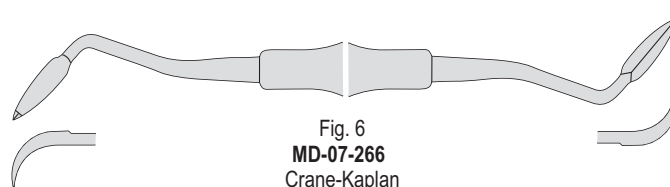


Fig. 6  
**MD-07-266**  
 Crane-Kaplan

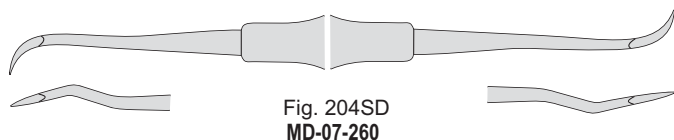


Fig. 204SD  
**MD-07-260**

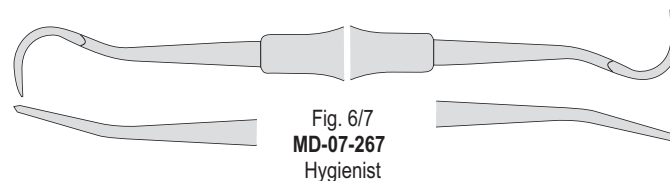


Fig. 6/7  
**MD-07-267**  
 Hygienist

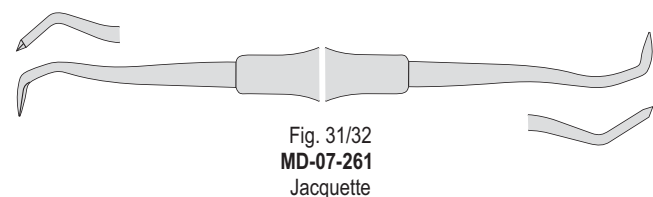


Fig. 31/32  
**MD-07-261**  
 Jacquette

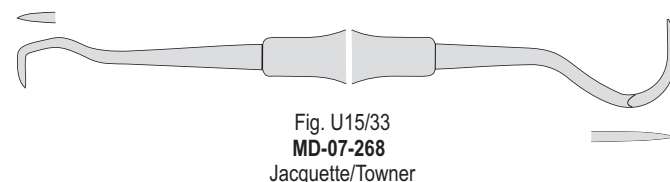


Fig. U15/33  
**MD-07-268**  
 Jacquette/Towner

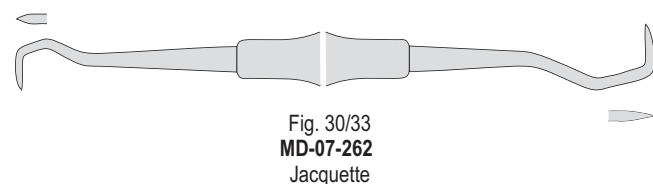


Fig. 30/33  
**MD-07-262**  
 Jacquette

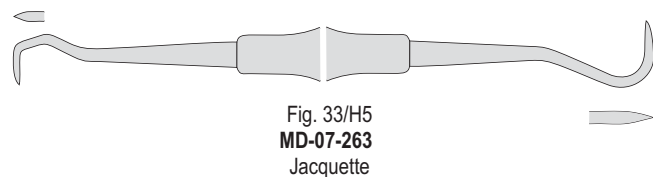


Fig. 33/H5  
**MD-07-263**  
 Jacquette

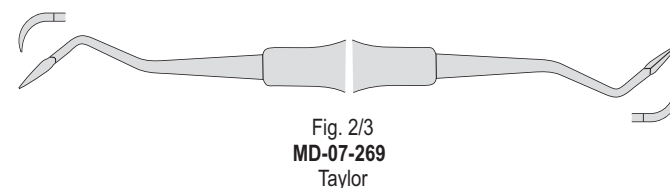


Fig. 2/3  
**MD-07-269**  
 Taylor

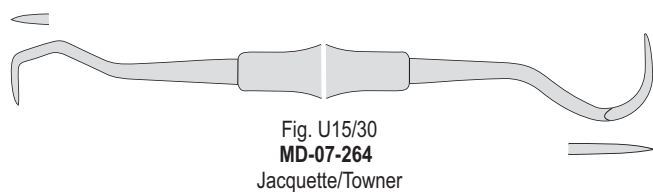


Fig. U15/30  
**MD-07-264**  
 Jacquette/Towner

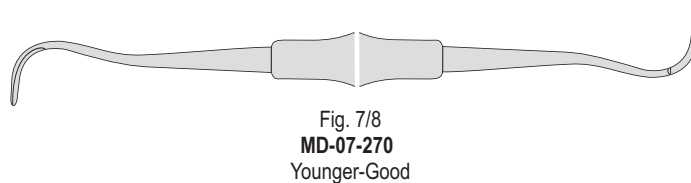


Fig. 7/8  
**MD-07-270**  
 Younger-Good



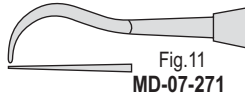


## SCALERS SINGLE ENDED

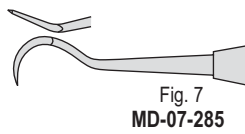
Solid Handle



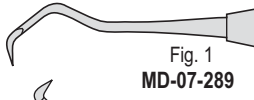
Darby Perry



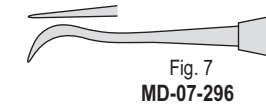
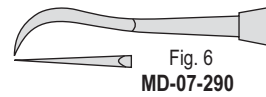
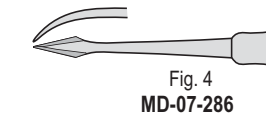
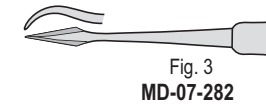
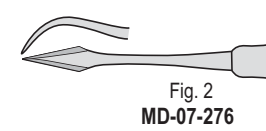
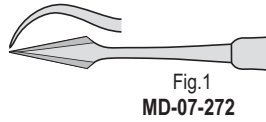
Hygienist



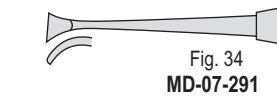
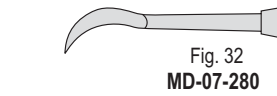
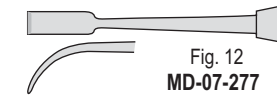
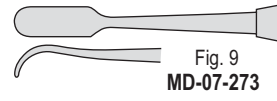
Jacquette



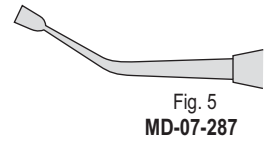
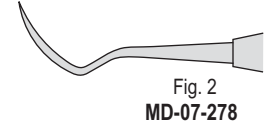
Standard



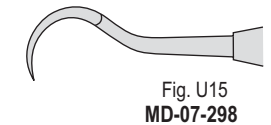
Standard



MRU Palma



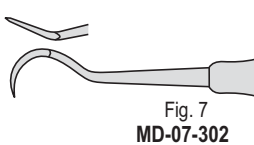
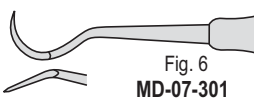
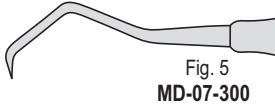
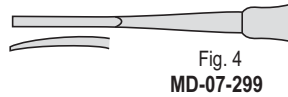
Towner



Hollow Handle 8mm



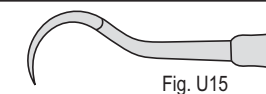
Hygienist



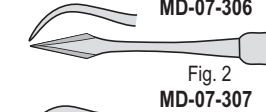
Jacquette



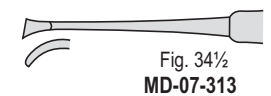
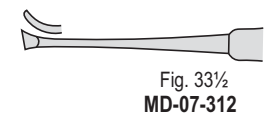
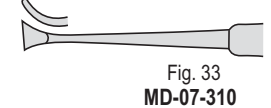
Towner



Standard

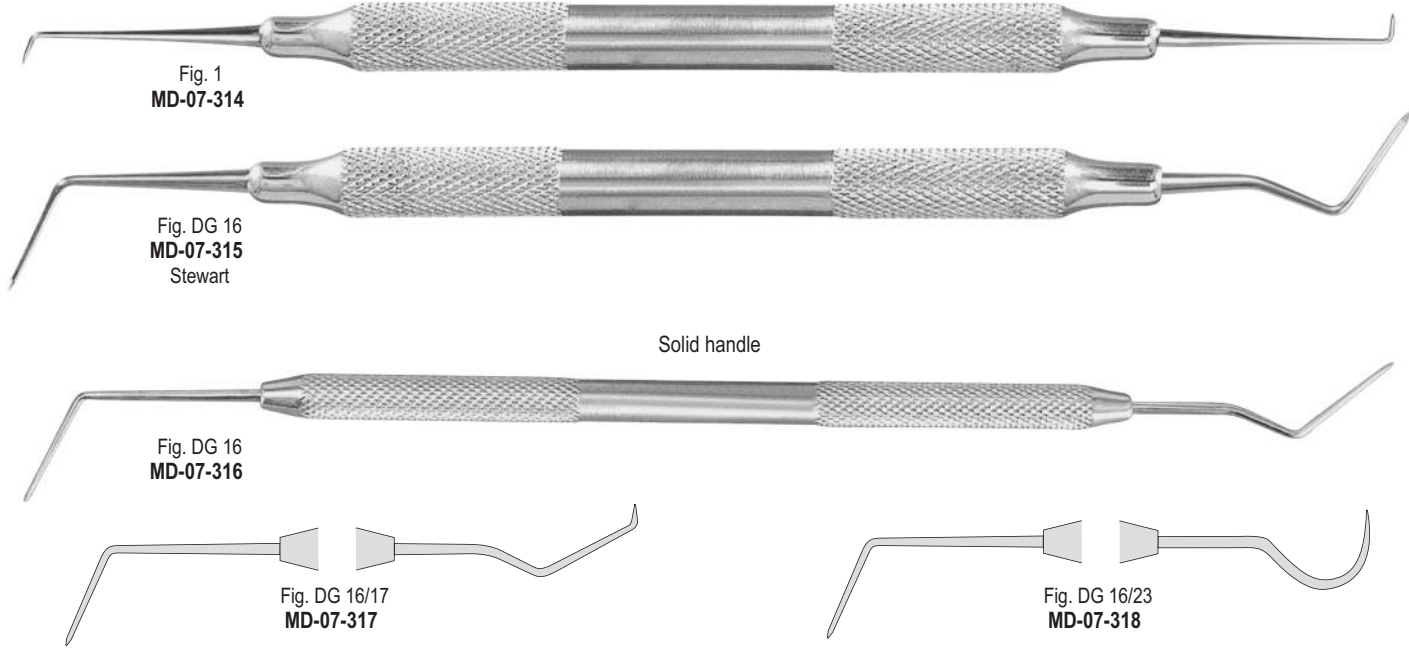


Standard

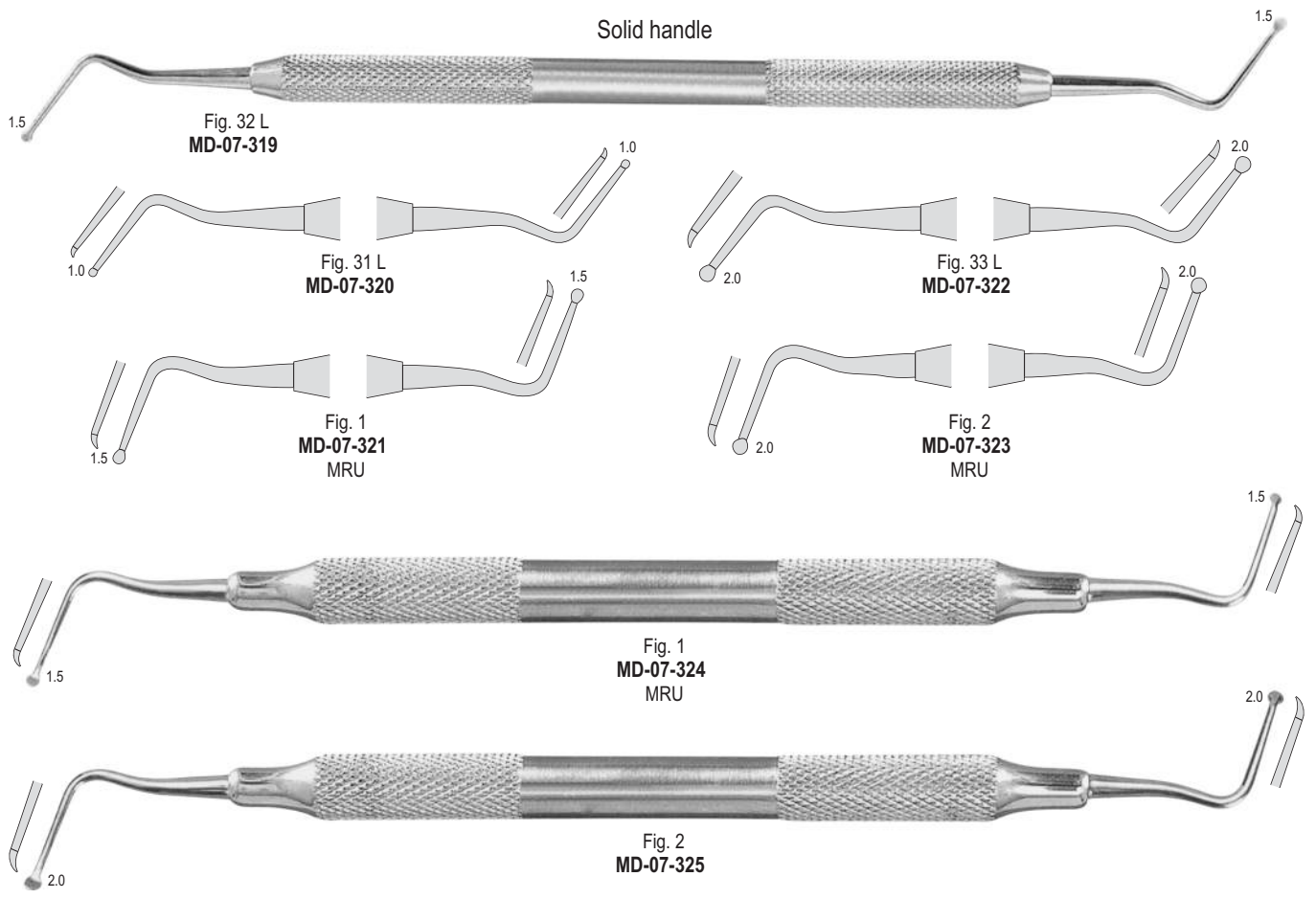


## ENDODONTIC INSTRUMENTS

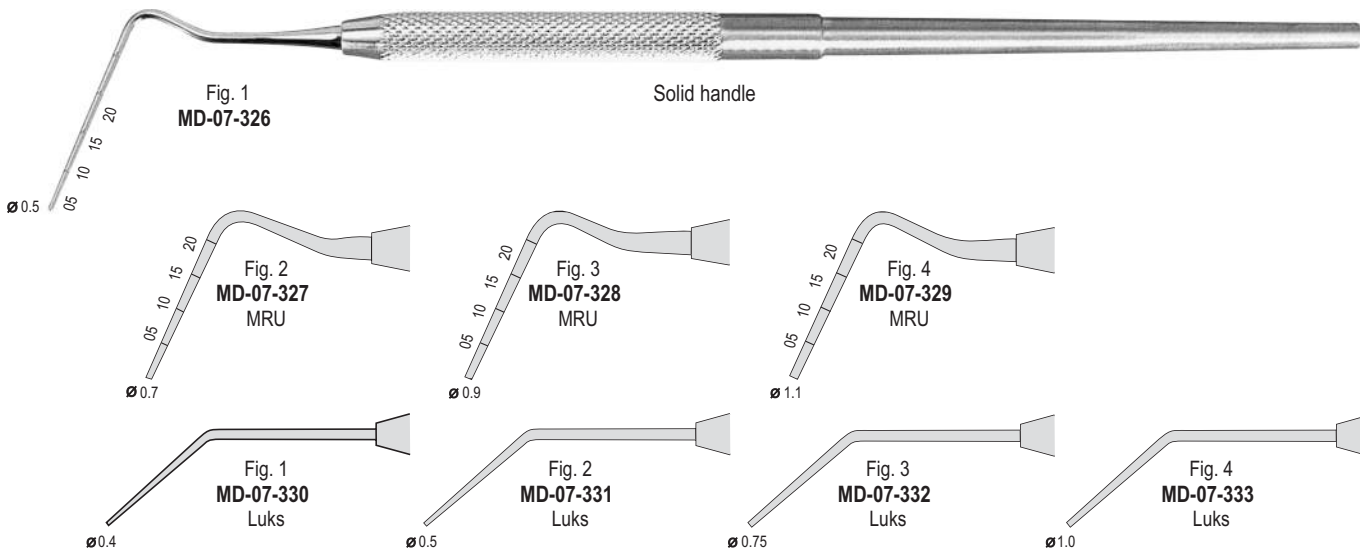
### Endodontic explorers



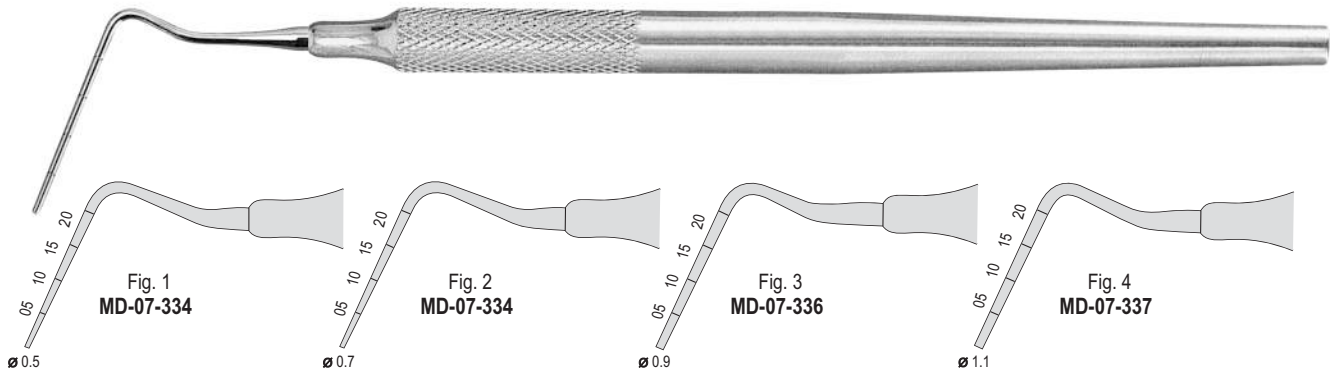
### Endodontic excavators



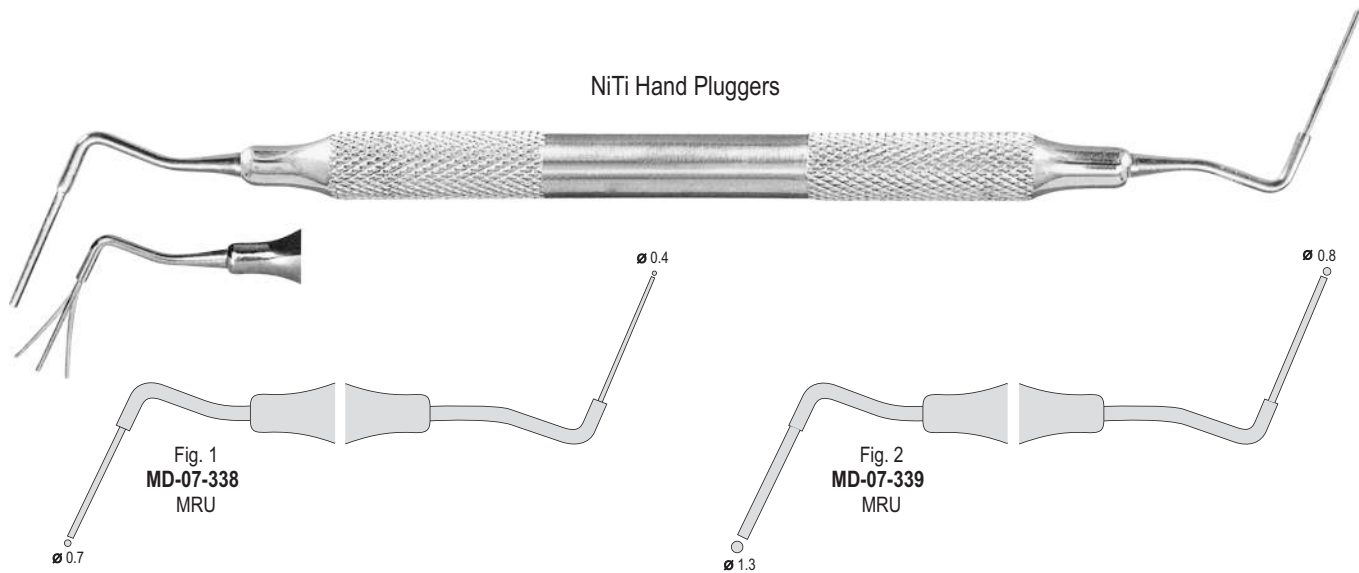
### Hand Pluggers



### Hollow handle 8mm



### NiTi Hand Pluggers



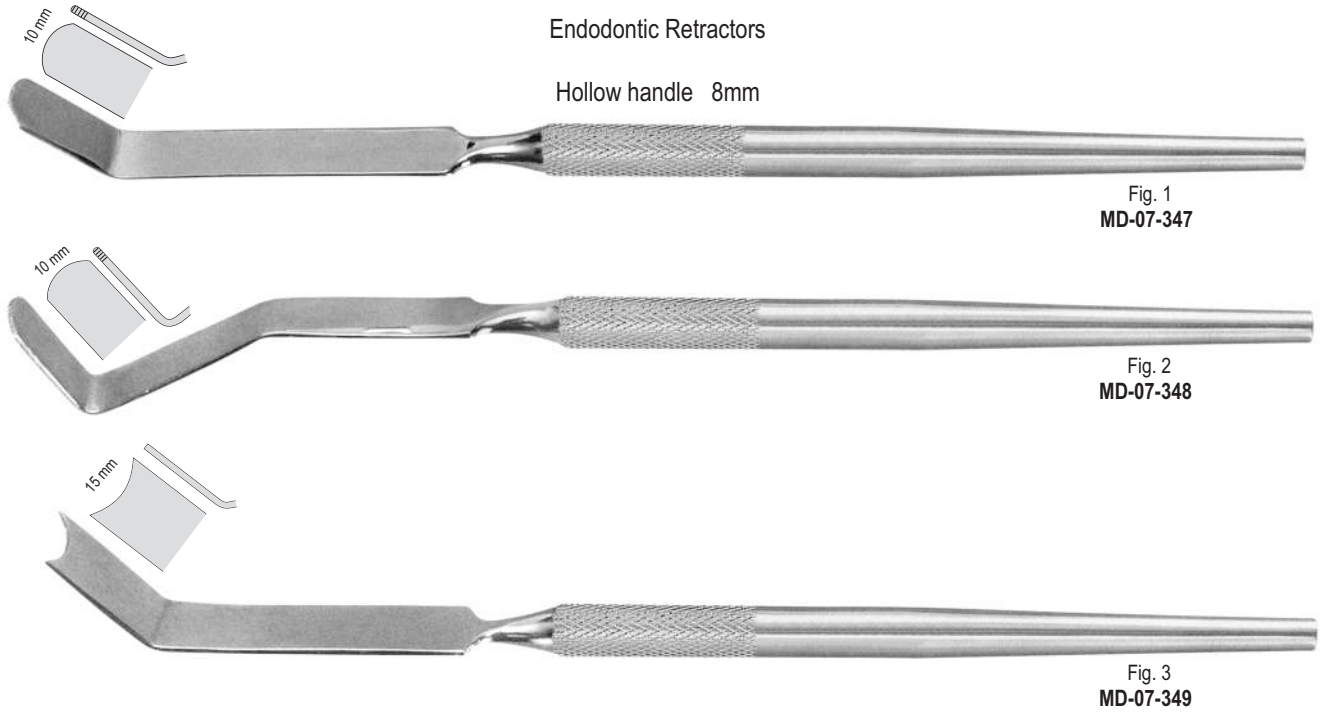
ENDODONTIC INSTRUMENTS

Micro endodontic pluggers/burnishers

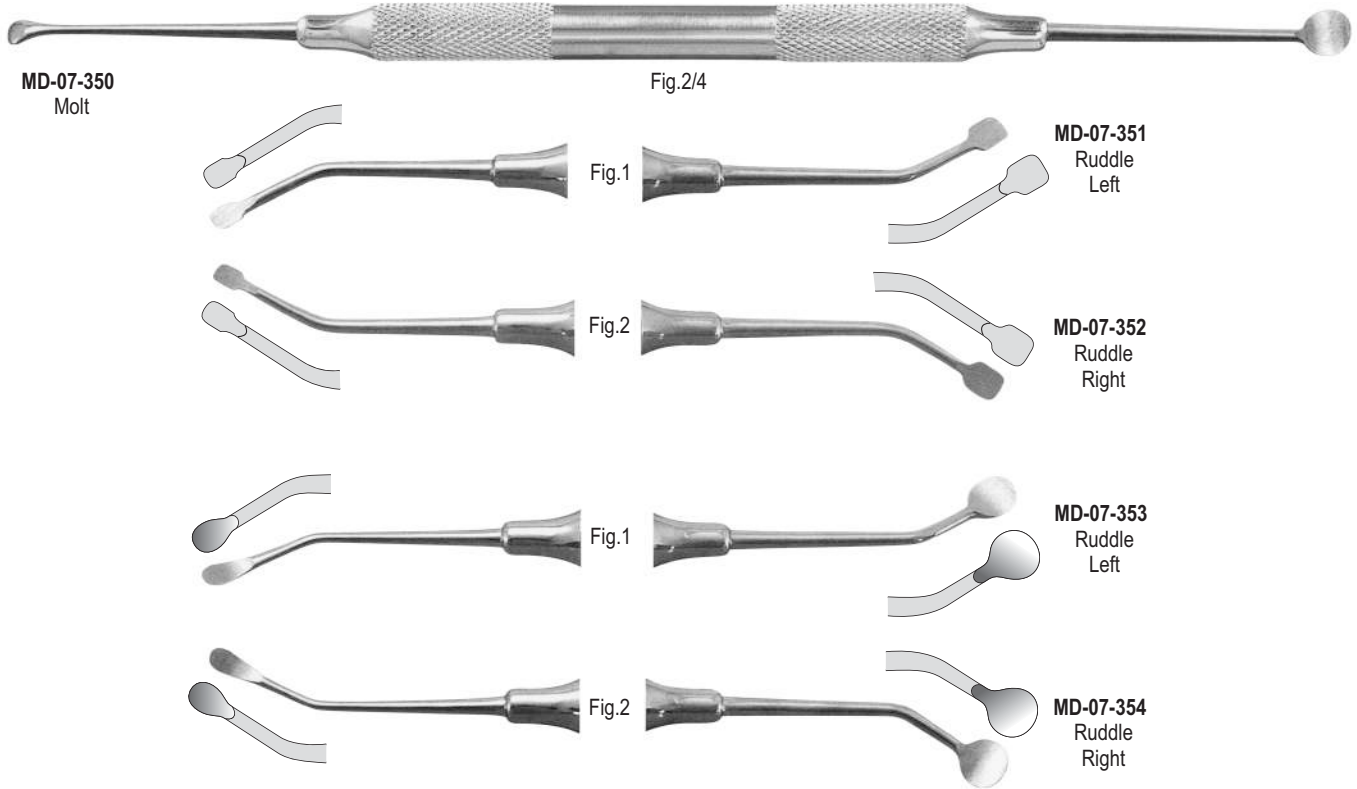


Endodontic Retractors

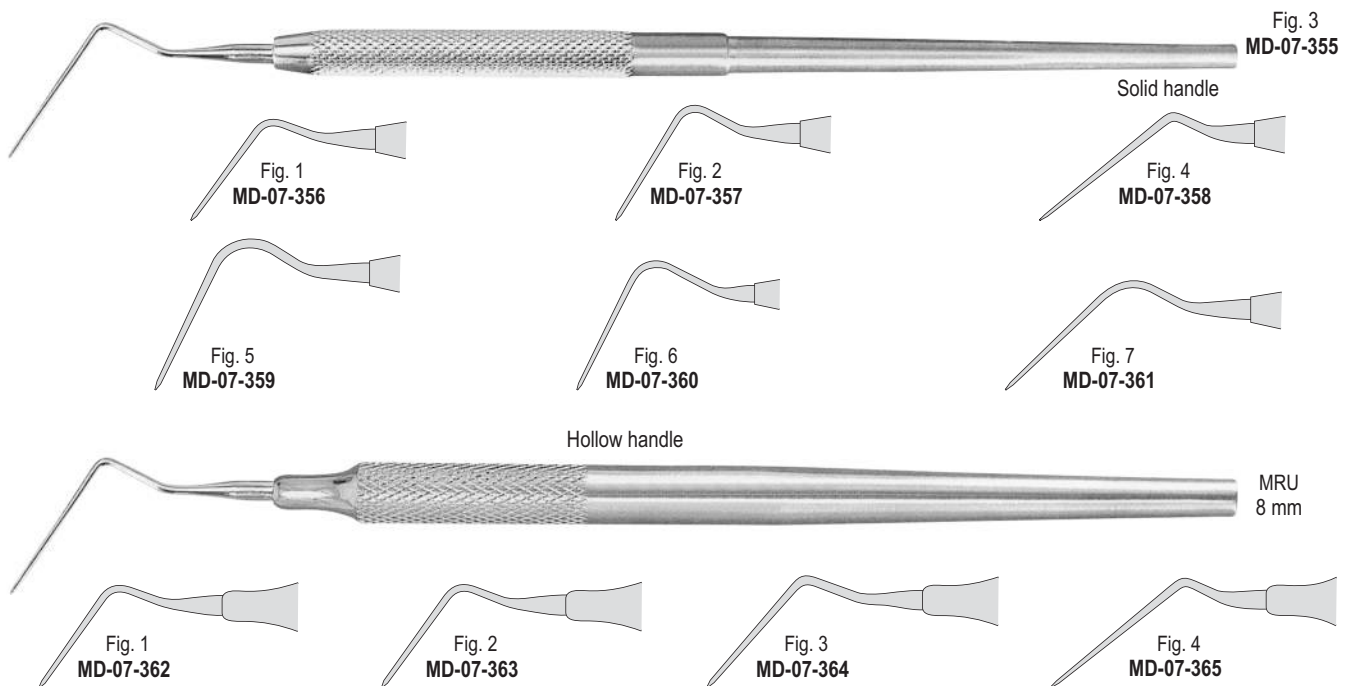
Hollow handle 8mm



Endodontic Curettes



Hand Spreaders



ENDODONTIC INSTRUMENTS



Fig. 1  
MD-07-366

Perforation Repair Instruments

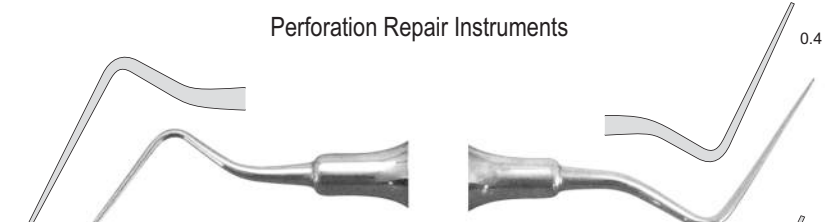


Fig. 1  
MD-07-367



Fig. 2  
MD-07-368

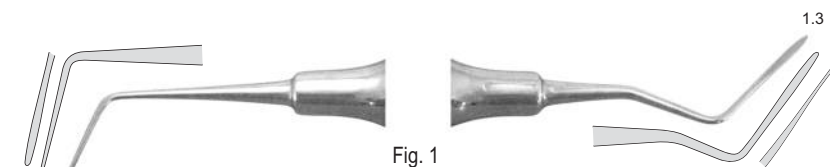


Fig. 1  
MD-07-369

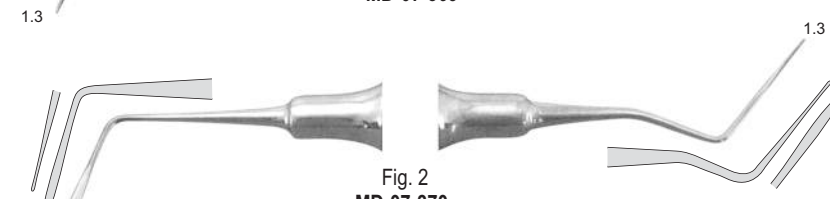


Fig. 2  
MD-07-370

Endodontic Forceps

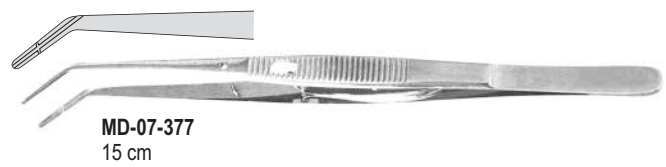
Micro forceps for removing broken files



Silver points and broken files removing forceps



Endodontic Tweezers



MD-07-377  
15 cm

Silicone Handle, Ultra Light weight, Non-stick tips, TiN coated

### Pluggers



Fig. 5A MD-07-378



Fig. 3 MD-07-379 Hollenback



Fig. 1 MD-07-380 Super



Fig. OT MD-07-381 Tanner



Fig. 0/1 MD-07-382



Fig. 1/2 MD-07-383



Fig. 21B MD-07-384 Acorn/Wescott



Fig. 1 MD-07-385 Contact Former



Fig. 2 MD-07-386 Contact Former

### Burnishers



Fig. 2 MD-07-387 Ladmore



Fig. 3 MD-07-388 Ladmore



Fig. 27/29 MD-07-389



Fig. 1 MD-07-390



Fig. 1L MD-07-391



Fig. 155 MD-07-392



Fig. 156(A6) MD-07-393



Fig. 8A MD-07-394



Fig. 1 MD-07-395 Boghosian

## FILLING INSTRUMENTS



Fig. 2 MD-07-396 Boghosian



Fig. 1 MD-07-397 MRU

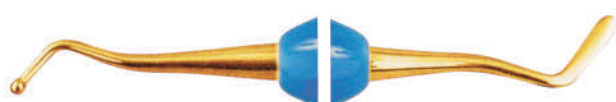


Fig. 2 MD-07-398 MRU



Fig. 1 MD-07-399 Goldstein



Fig. 2 MD-07-400 Goldstein



Fig. 3 MD-07-401 Goldstein



Fig. 4 MD-07-402 Goldstein



Fig. 1 MD-07-403 Goldstein-Mini



Fig. 3 MD-07-404 Goldstein-Mini



Fig. 4 MD-07-405 Goldstein-Mini



Fig. 1 MD-07-406 Goldstein-Micro



Fig. 4/5 MD-07-407 Gregg



Fig. 0 MD-07-408 Heidemann



Fig. 1 MD-07-409 Heidemann



Fig. 2 MD-07-410 Heidemann



Fig. W3 MD-07-411



Fig. 1 MD-07-412



Fig. 6 MD-07-413



Fig. 178 MD-07-414



Fig. 49 MD-07-415



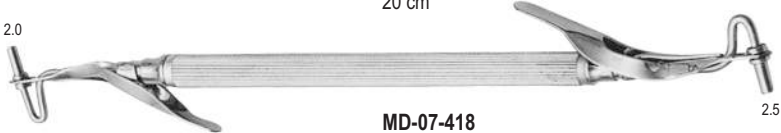
Fig. 179 MD-07-416



### Amalgam Carriers



**MD-07-417**  
Mini/Regular  
20 cm



**MD-07-418**  
Regular/Large  
20 cm



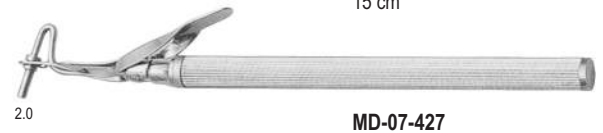
**MD-07-419**  
Regular/Jumbo  
20 cm



**MD-07-420**  
Large/Jumbo  
20 cm



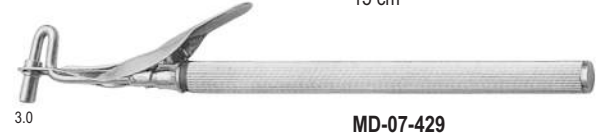
**MD-07-426**  
Mini  
15 cm



**MD-07-427**  
Regular  
15 cm



**MD-07-428**  
Large  
15 cm



**MD-07-429**  
Jumbo  
15 cm



Fig. 10  
**MD-07-421**  
English pattern 16.5 cm



Fig. 1  
**MD-07-422**  
German pattern 18.5 cm

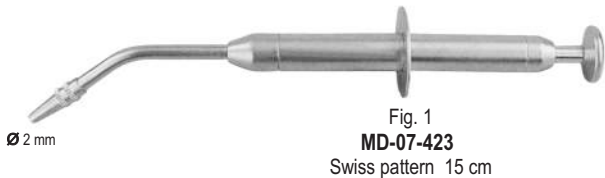


Fig. 1  
**MD-07-423**  
Swiss pattern 15 cm



Fig. 1  
**MD-07-430**  
Regular 15 cm



Fig. 2  
**MD-07-431**  
Regular 15 cm



Fig. 3  
**MD-07-432**  
Regular 14 cm

### For micro filling



**MD-07-424** Str  
**MD-07-425** Cvd  
13 cm

### Amalgam well

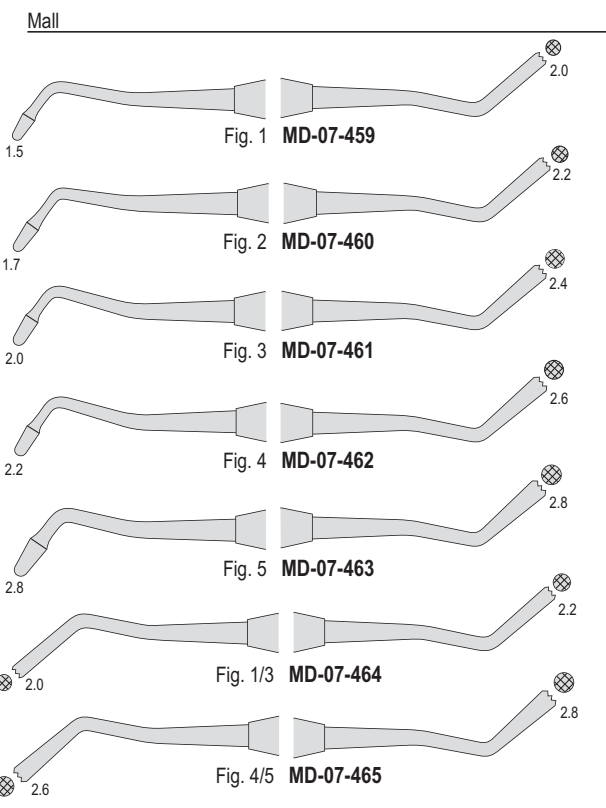
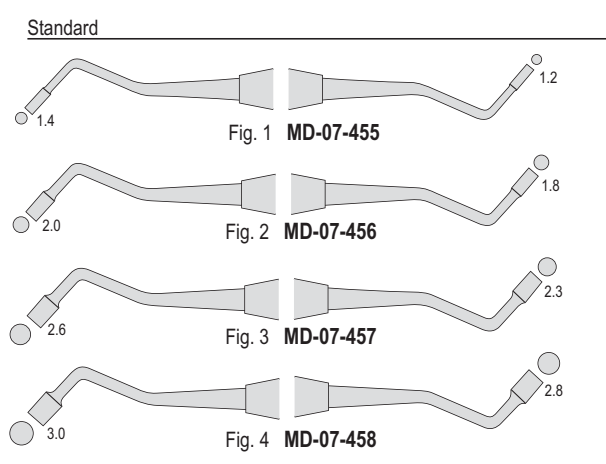
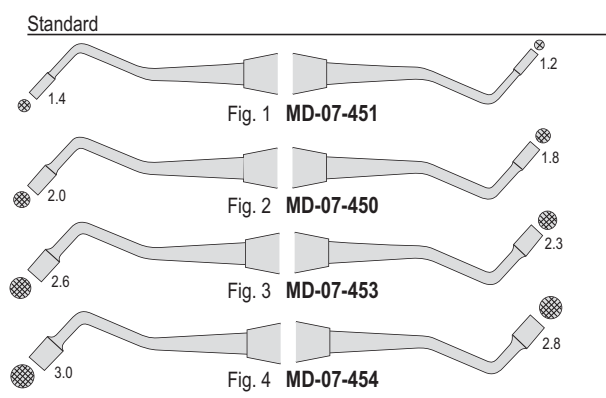
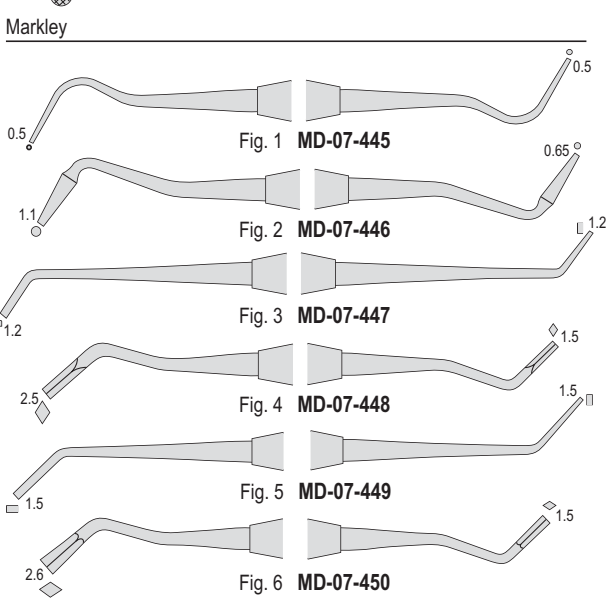
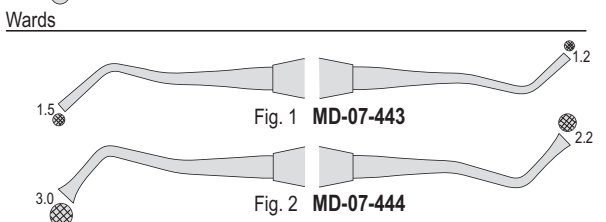
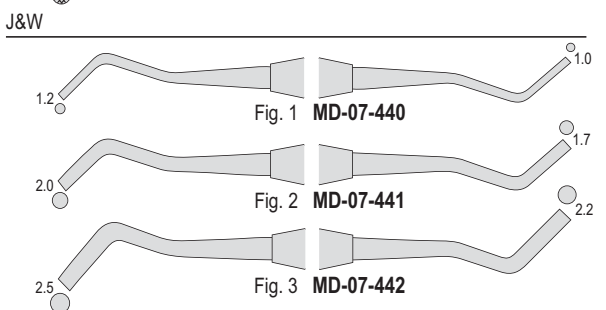
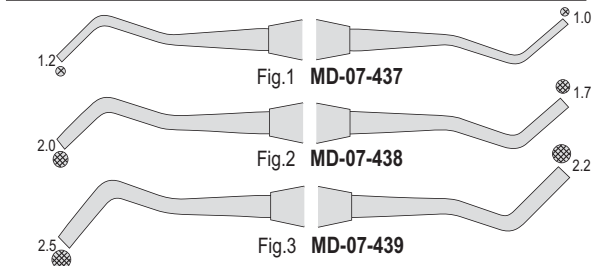
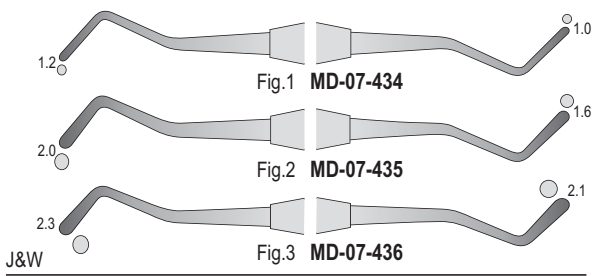


**MD-07-433**



AMALGAM PLUGGERS / CONDENSERS

Solid handle





## AMALGAM PLUGGERS / CONDENSERS

Super Plugger Hollow 8 mm

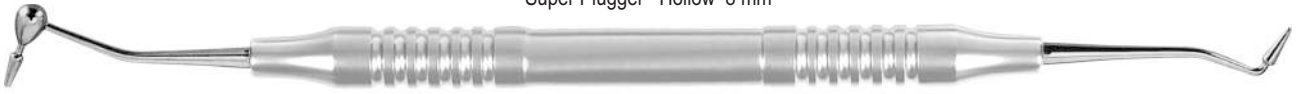


Fig. 1 MD-07-466



Fig. 1 MD-07-467



Fig. 2 MD-07-468



Fig. 3 MD-07-469

J&W



Fig. 1 MD-07-470

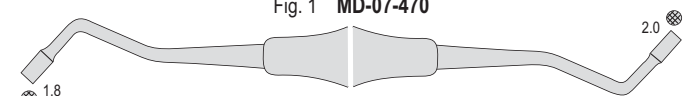


Fig. 2 MD-07-471

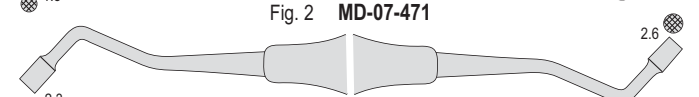


Fig. 3 MD-07-471

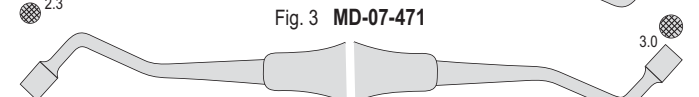


Fig. 4 MD-07-472

Markley

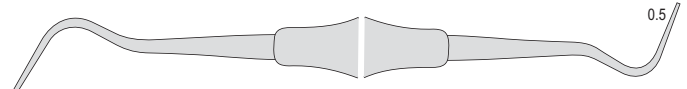


Fig. 1 MD-07-473



Fig. 2 MD-07-474

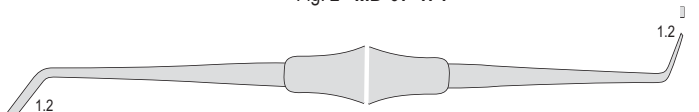


Fig. 3 MD-07-475

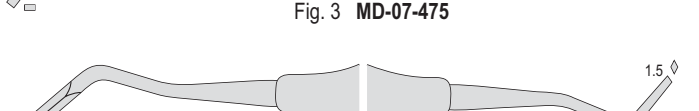


Fig. 4 MD-07-476



Fig. 5 MD-07-477



Fig. 6 MD-07-478

Solid handle



Black



Fig. 0/1 MD-07-483

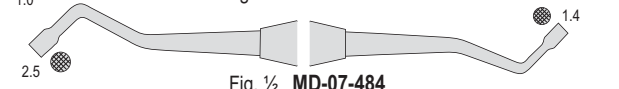


Fig. 1/2 MD-07-484

J&W Palma

J&W Palma



Fig. 1 MD-07-479



Fig. 2 MD-07-480



Fig. 3 MD-07-481



Fig. 4 MD-07-482



Fig. 1 MD-07-485

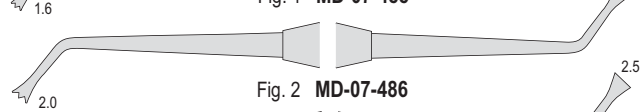


Fig. 2 MD-07-486



Fig. 3 MD-07-487



Fig. 4 MD-07-488

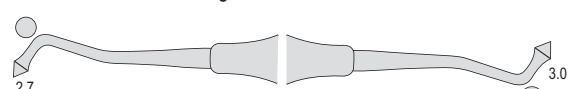
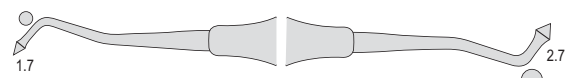


BURNISHERS

Hollow handle 8 mm



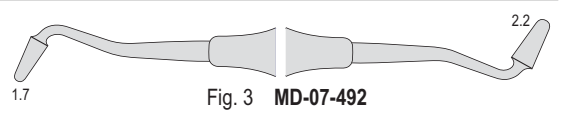
Acorn / Wescott



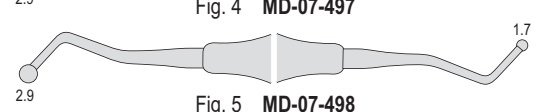
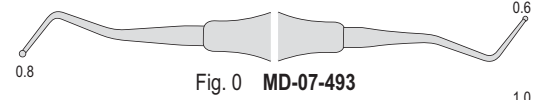
White



Freedman



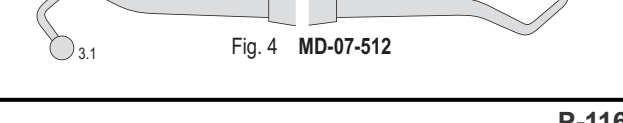
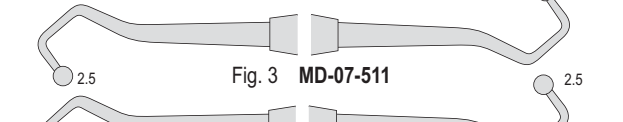
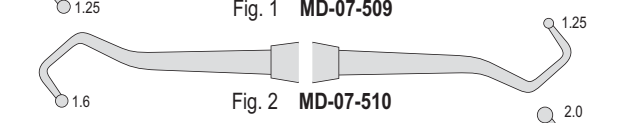
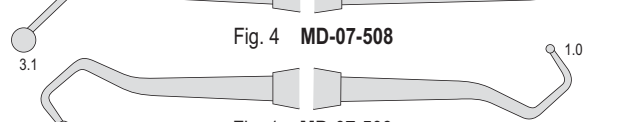
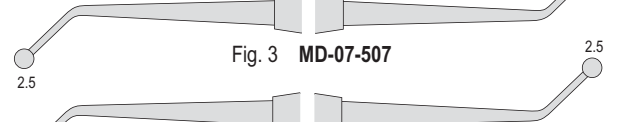
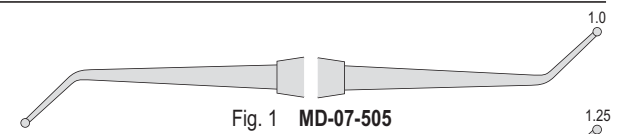
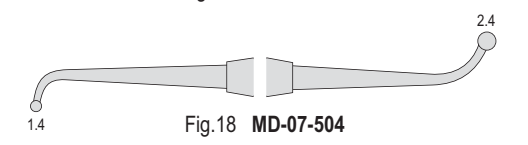
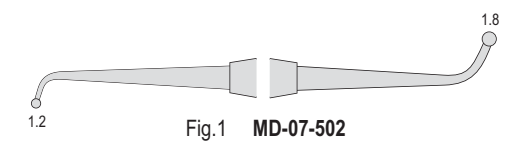
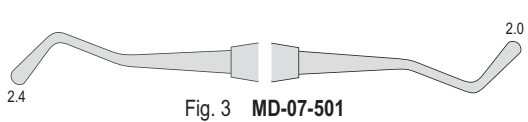
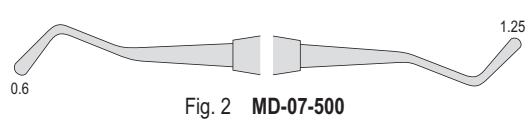
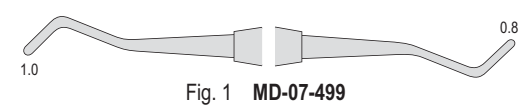
J&W



Solid Handle



J&W Palma



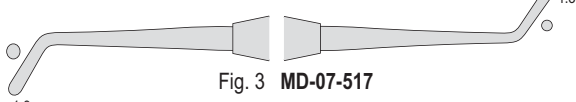
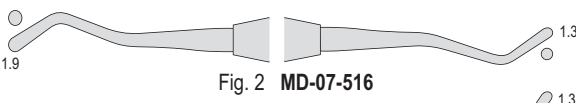
### Solid handle



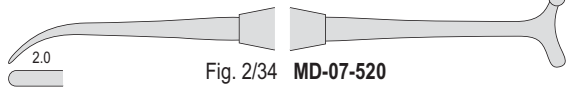
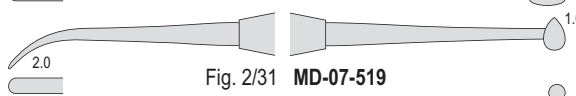
Acom / Wescott



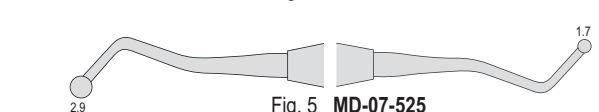
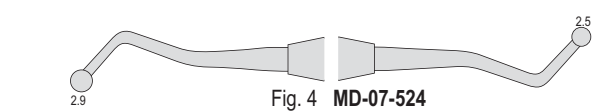
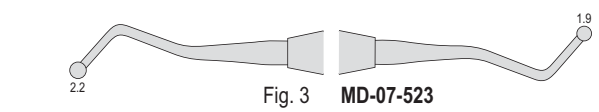
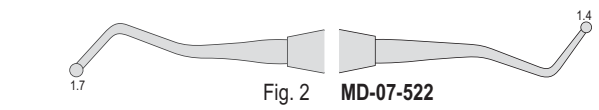
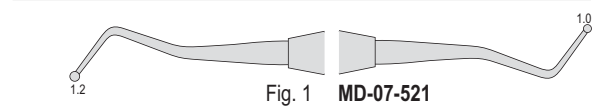
Ladmore



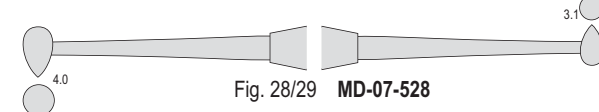
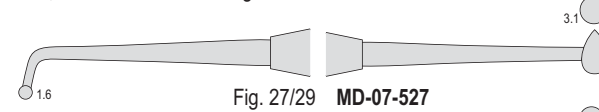
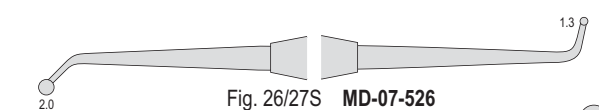
Beavertail / White



J&W



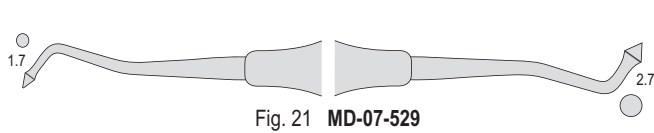
White



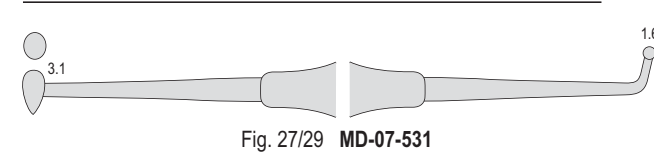
### Hollow handle



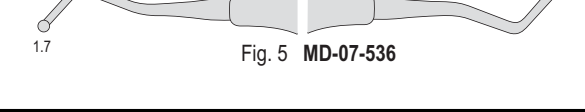
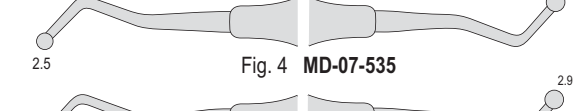
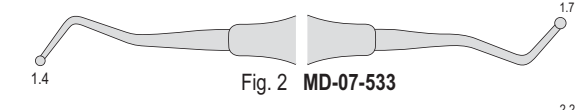
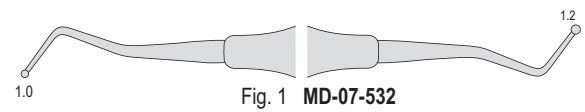
Acom / Wescott



White



J&W



## COMPOSITE / PLASTIC FILLING INSTRUMENTS

Solid handle

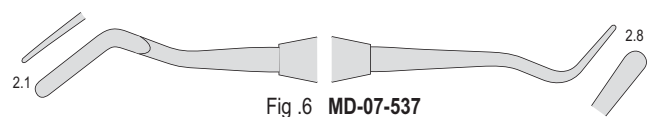


Fig. 6 MD-07-537

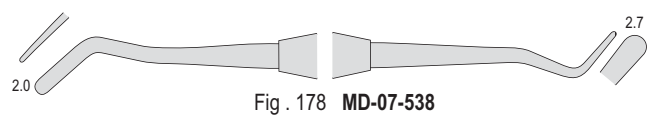


Fig. 178 MD-07-538



Fig. 179 MD-07-539

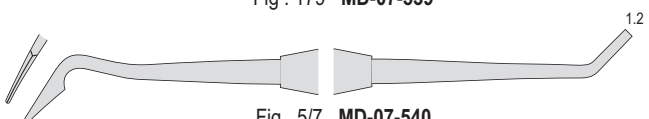


Fig. 5/7 MD-07-540

Gregg

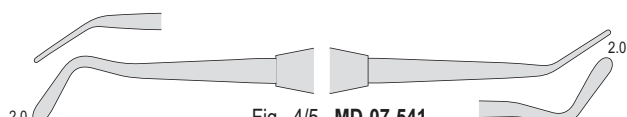


Fig. 4/5 MD-07-541

Woodson

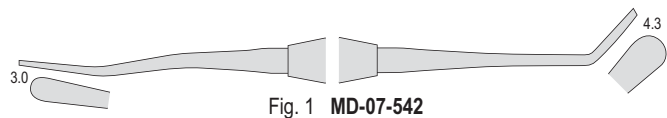


Fig. 1 MD-07-542



Fig. 2 MD-07-543



Fig. 3 MD-07-544

Heidemann

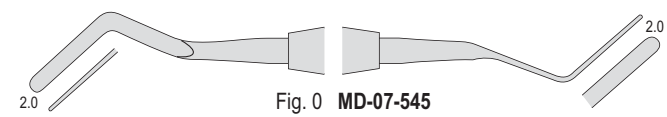


Fig. 0 MD-07-545

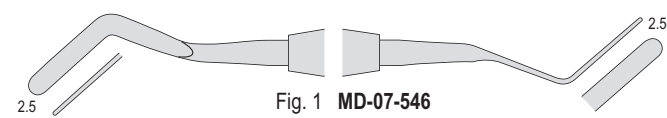


Fig. 1 MD-07-546

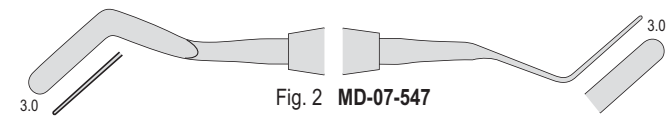


Fig. 2 MD-07-547

J&W

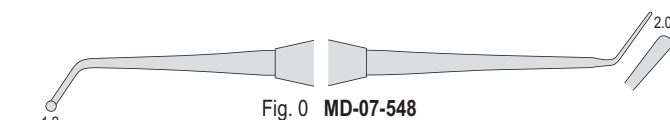


Fig. 0 MD-07-548



Fig. 1 MD-07-549



Fig. 2 MD-07-550

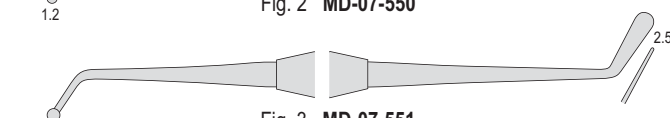


Fig. 3 MD-07-551

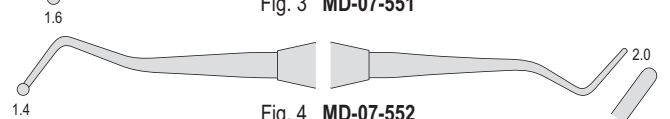


Fig. 4 MD-07-552

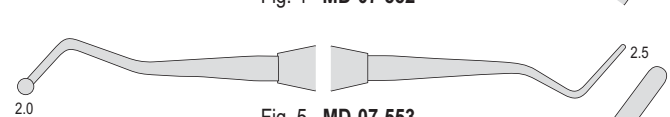


Fig. 5 MD-07-553

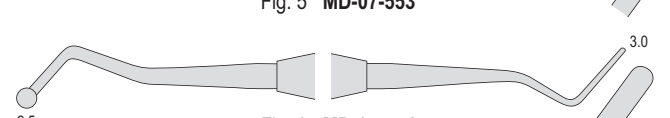


Fig. 6 MD-07-554

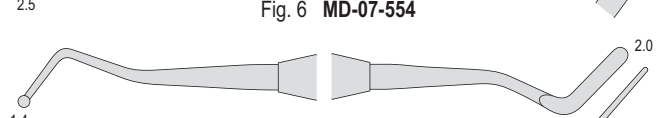


Fig. 7 MD-07-555

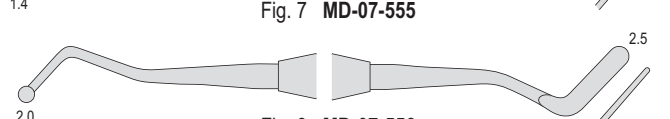


Fig. 8 MD-07-556

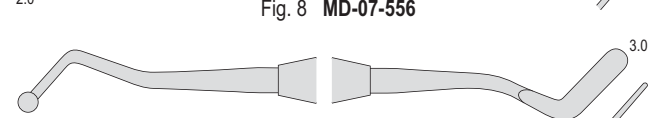


Fig. 9 MD-07-557

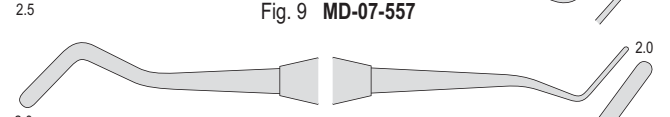


Fig. 10 MD-07-558

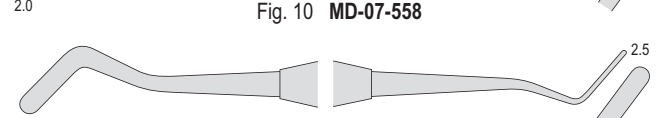


Fig. 11 MD-07-559

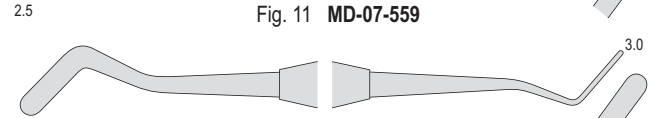


Fig. 12 MD-07-560

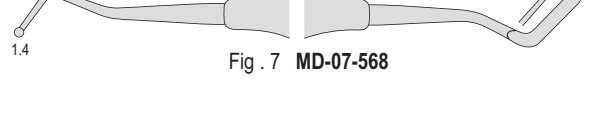
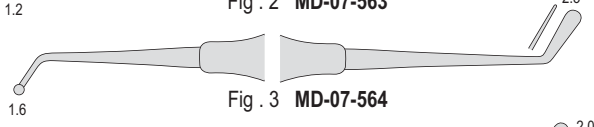
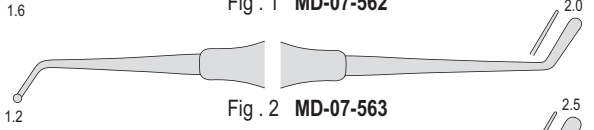
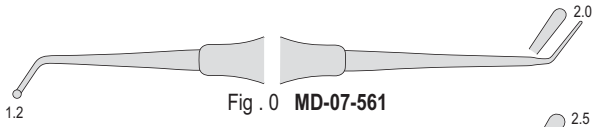


COMPOSITE / PLASTIC FILLING INSTRUMENTS

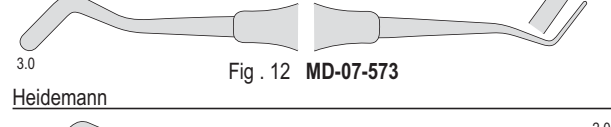
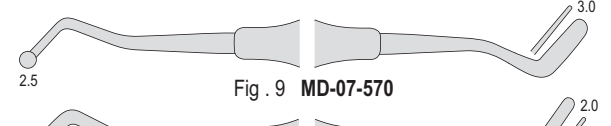
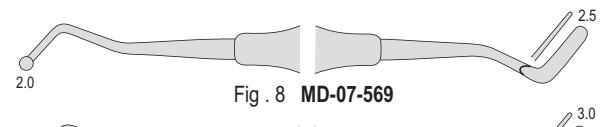
Hollow handle



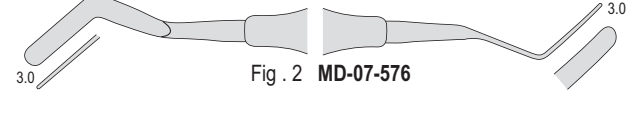
J&W



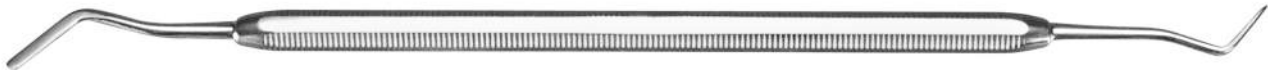
J&W



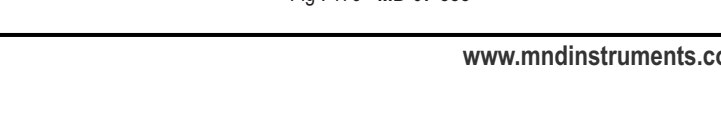
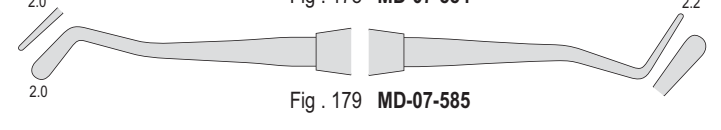
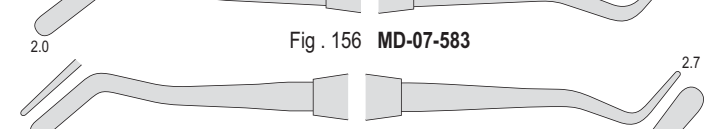
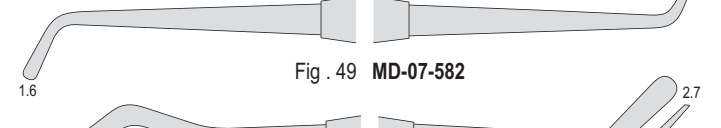
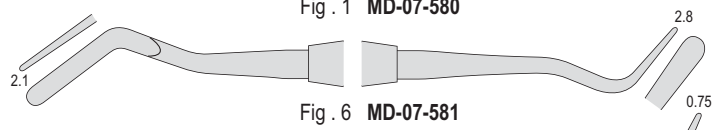
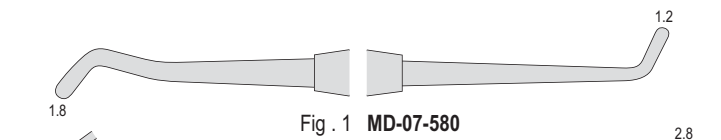
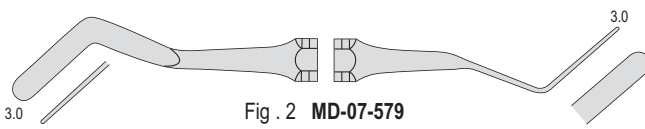
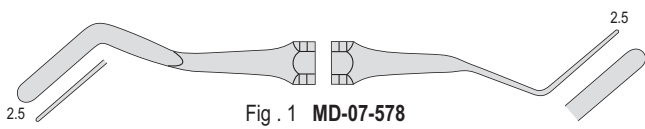
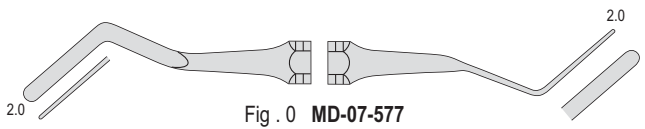
Heidemann



Solid handle

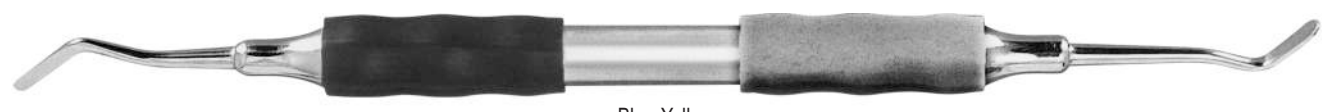


J&W

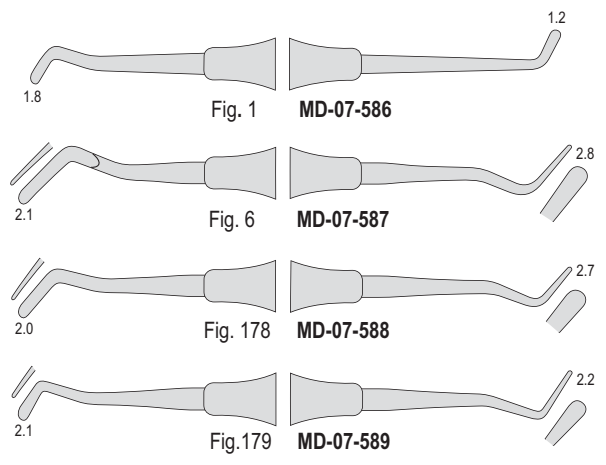




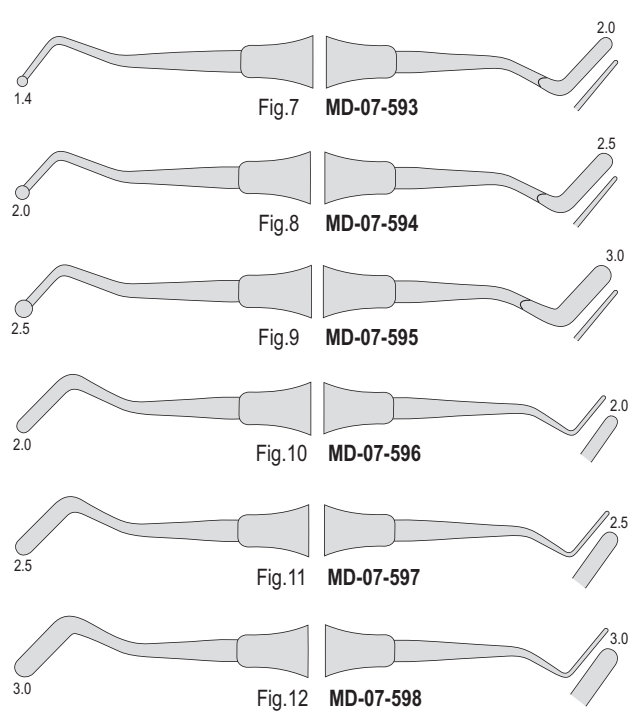
COMPOSITE / PLASTIC FILLING INSTRUMENTS



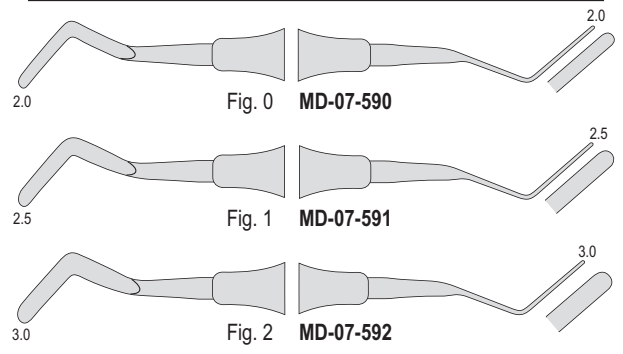
Blue-Yellow



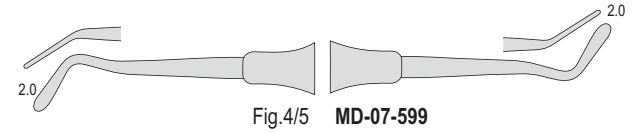
J&W



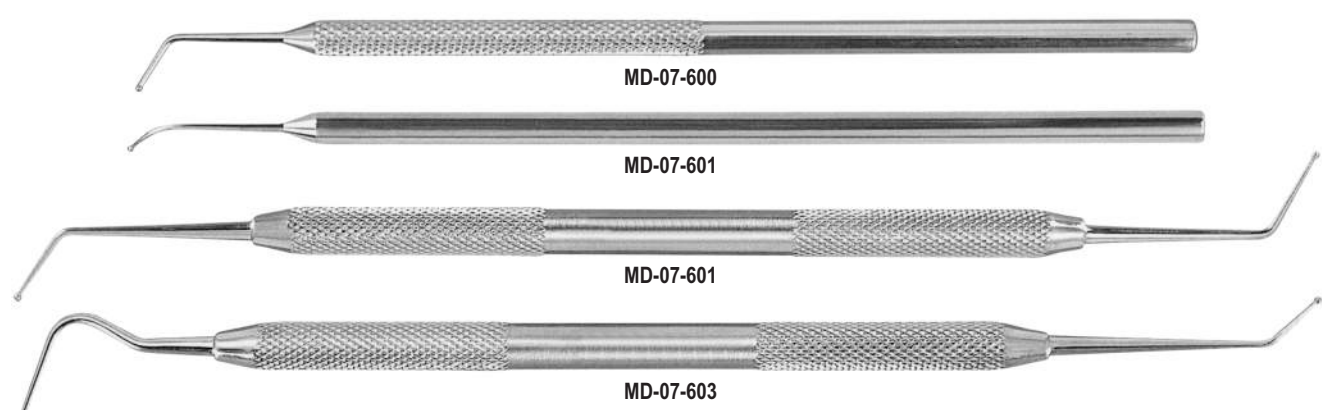
Heidemann



Gregg



Applicators for calcium hydroxide



Applicator for medicaments







Blue-Yellow

J&W

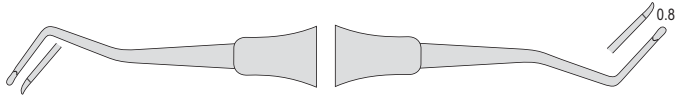


Fig. 0 MD-07-605



Fig. 1 MD-07-606

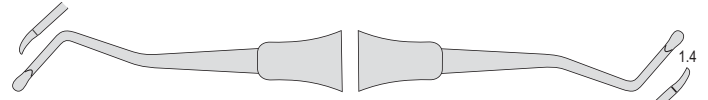


Fig. 2 MD-07-607

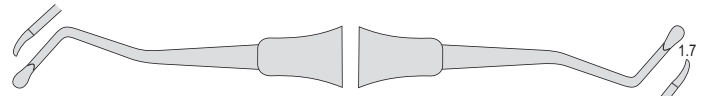


Fig. 3 MD-07-608

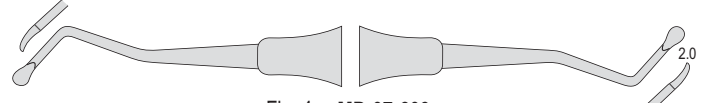


Fig. 4 MD-07-609



Solid handle

J&W



Fig. 0 MD-07-610



Fig. 1 MD-07-611

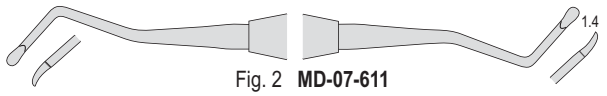


Fig. 2 MD-07-611

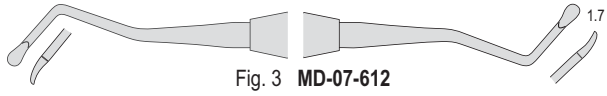


Fig. 3 MD-07-612



Fig. 4 MD-07-613



Fig. 6 MD-07-614



Fig. 14 MD-07-615



Fig. 17 MD-07-616

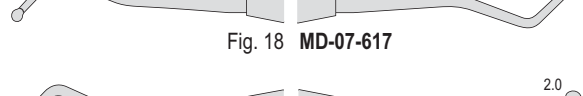


Fig. 18 MD-07-617



Fig. 19 MD-07-618

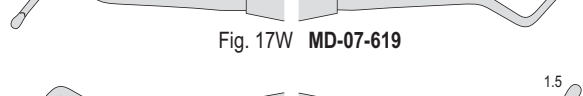


Fig. 17W MD-07-619



Fig. 18W MD-07-620



Fig. 19W MD-07-621

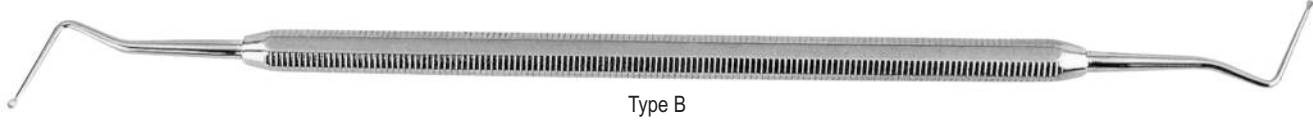
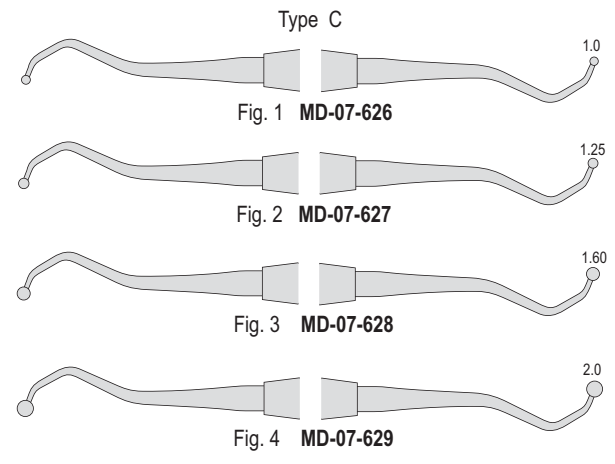
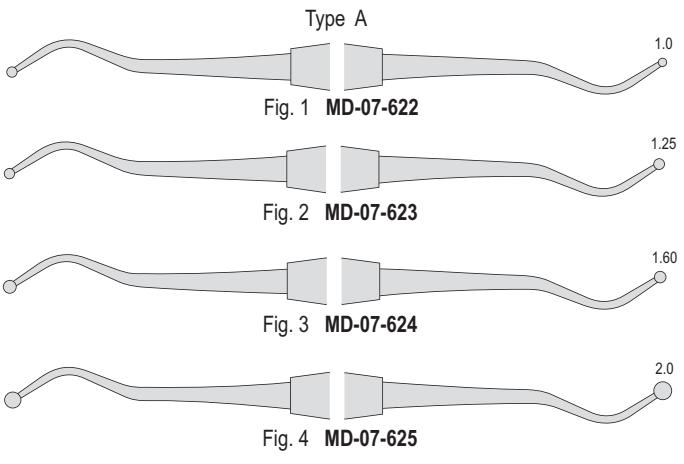


EXCAVATORS



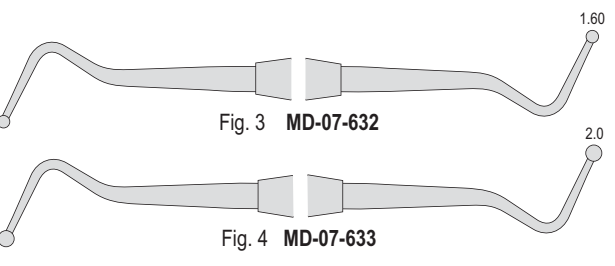
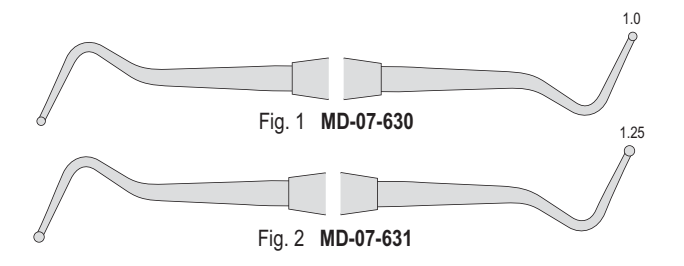
Solid handle

J&W Palma



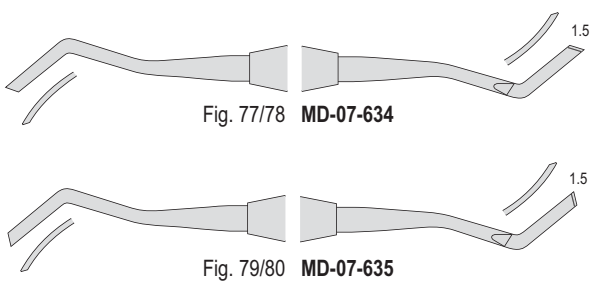
Type B

J&W Palma

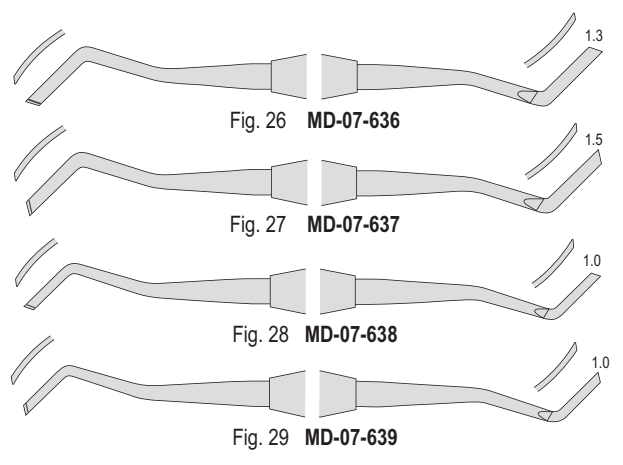


Solid handle

Blacks



Ferrier



Carvers



Fig. 3 MD-07-640 Hollenback

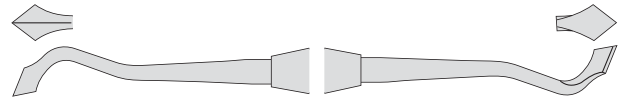


Fig. 2/3 MD-07-644 Frahm

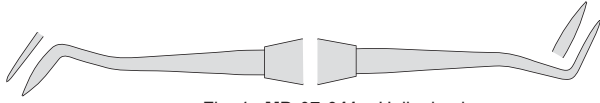


Fig. 4 MD-07-641 Hollenback

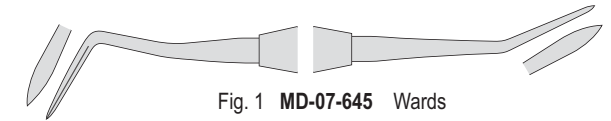


Fig. 1 MD-07-645 Wards

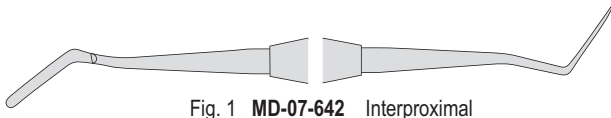


Fig. 1 MD-07-642 Interproximal

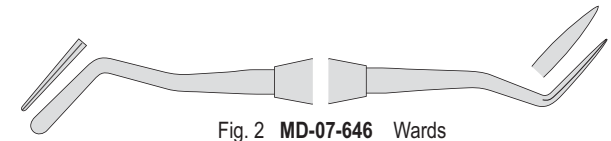


Fig. 2 MD-07-646 Wards



Fig. 2 MD-07-643 Interproximal

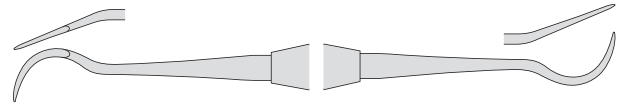


Fig. 8 MD-07-647 Wiland

Carvers



Fig. 3 MD-07-648 Hollenback



Fig. 3 1/2 MD-07-649 Hollenback

Finishing knives



Fig. 2 MD-07-650 USC



Fig. 2S MD-07-651 USC



Fig. 28 MD-07-652 Black



Fig. 29 MD-07-653 Black

## FINISHING KNIVES & CLEOID-DISCOID

### Finishing knives

Hollow handle



Fig. 6T **MD-07-654** Tanner



Fig. 2 **MD-07-655** USC



Fig. 2S **MD-07-656** USC

### Cleoid - Discoid

Solid handle

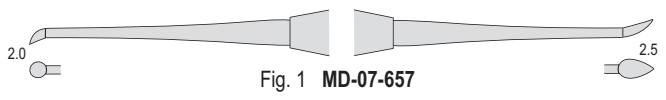


Fig. 1 **MD-07-657**

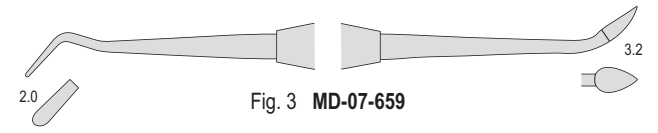


Fig. 3 **MD-07-659**

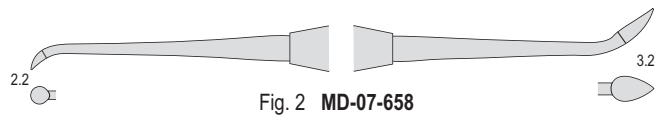


Fig. 2 **MD-07-658**



Fig. 4 **MD-07-660**

### Cleoid - Discoid

Yellow-Orange

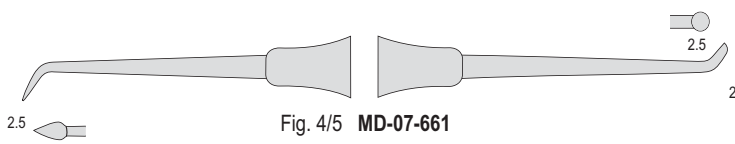
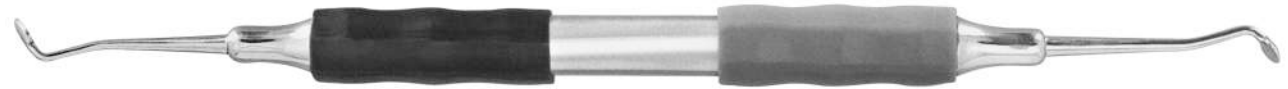


Fig. 4/5 **MD-07-661**

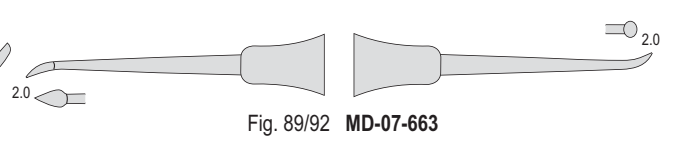


Fig. 89/92 **MD-07-663**

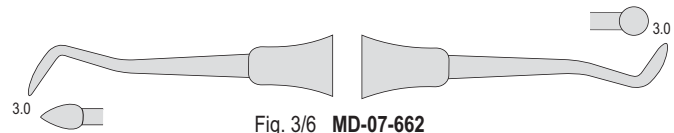


Fig. 3/6 **MD-07-662**



Fig. 90B **MD-07-664**

### Filling removing instrument



Fig. 1 **MD-07-665** Yellow-Orange



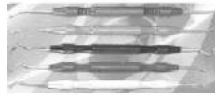
P.K. Thomas



Fig. 1 MD-07-666 Green



Fig. 2 MD-07-667 Yellow



54-B Set of 5 Pieces



Fig. 4 MD-07-669 Orange



Fig. 3 MD-07-668 Blue



Fig. 5 MD-07-670 Silver



Fig. 1 MD-07-671



Fig. 2 MD-07-672



MD-07-676 P.K. Thomas Set of 5 Pieces



Fig. 4 MD-07-674



Fig. 3 MD-07-673



Fig. 5 MD-07-675



Fig. 7 MD-07-677 Beale



Fig. 31 MD-07-678 Gritman



Fig. 10 MD-07-680 Lecron



Fig. 10 MD-07-679 Hylin



Fig. 10 MD-07-681 Zahle



Fig. 1 MD-07-682 Vehe



Fig. 31 MD-07-683 Gritman



Fig. 13 MD-07-685



Fig. 12 MD-07-684



Fig. 1 MD-07-686 Beale



Fig. 1 MD-07-687 Roach

Akers Carver



MD-07-688 Akers Complete



54-493-00 Handle Only

MD-07-689 Spoon Only

MD-07-690 Knife Tip Only

WAX MODELING CARVERS



Fig. 1 13 cm

Fig. 2 14 cm

Fig. 3 14 cm

Fig. 4 13.5 cm

Fig. 5 14 cm

Fig. 6 11.7 cm

Fig. 7 11.5 cm

Fig. 1 Zahle 12 cm

Fig. 2 Zahle 12.5 cm

Fig. 3 Zahle 12.5 cm

Fig. 4 Zahle 12 cm

Fig. 5 Zahle 12 cm

Fig. 6 Zahle 11.5 cm

MD-07-691 MD-07-692 MD-07-693 MD-07-694 MD-07-695 MD-07-696 MD-07-697 MD-07-698 MD-07-699 MD-07-700 MD-07-701 MD-07-702 MD-07-703



Fig. 1 Hylin 13.5 cm

Fig. 3 Hylin-Ceramica 13.5 cm

Fig. 5 Hylin 13.5 cm

Fig. 6 Hylin-Lecron 13.5 cm

Fig. 1 Lecron-mini 10 cm

Fig. 2 Lecron-mini 13 cm

Fig. 3 Lecron-mini 13 cm

Fig. 1 Lecron 16.5 cm

Fig. 2 Lecron 16.5 cm

Fig. 3 Lecron 16.5 cm

Fig. 4 Lecron 16.5 cm

Fig. 7 Lecron 16 cm

Fig. 8 Lecron 16 cm

MD-07-704 MD-07-705 MD-07-706 MD-07-707 MD-07-708 MD-07-709 MD-07-710 MD-07-711 MD-07-712 MD-07-713 MD-07-714 MD-07-715 MD-07-716



Fig. 1 MD-07-717 Hollow handle



Fig. 2 MD-07-718 Hollow handle



Fig. 3 MD-07-719 Solid handle



Fig. 1 MD-07-720 Solid handle



Fig. 2 MD-07-721 Solid handle



Fig. 3 MD-07-722



Fig. 00 MD-07-723

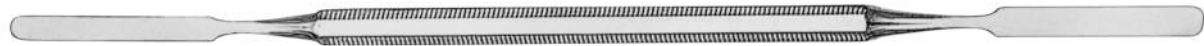


Fig. 0 MD-07-724



Fig. 1 MD-07-725



Fig. 2 MD-07-726



Fig. 3 MD-07-727



Fig. 4 MD-07-728



Weston MD-07-729



MD-07-730



MD-07-731

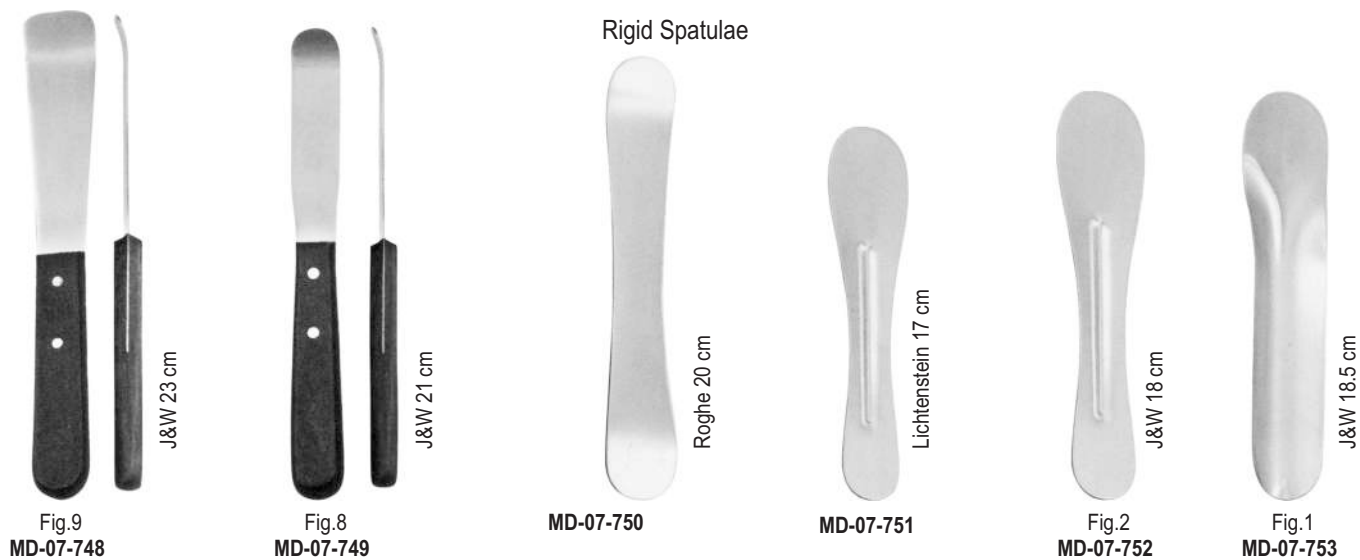
Plaster knives with wooden handle



Flexible Spatulae



Rigid Spatulae





Wax knives with plastic handle  
(Available in different colours)



MD-07-754 Fahnestock 13 cm



MD-07-756 Lessmann 13 cm



MD-07-755 Fahnestock 17.5 cm



MD-07-757 Lessmann 17.5 cm

Wax knives with wooden handle



MD-07-758 Fahnestock 13 cm



MD-07-760 Lessmann 13 cm



MD-07-759 Fahnestock 17.5 cm



MD-07-761 Lessmann 17.5 cm



MD-07-762 with spoon 13 cm



MD-07-763 with spoon 17.5 cm

Wax knives Ermert



MD-07-764 Wooden handle

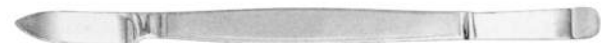


MD-07-765 Plastic handle



MD-07-766 Metal handle

Wax knives with metal handle



MD-07-767 Fahnestock 13 cm



MD-07-768 Fahnestock 17.5 cm



MD-07-769 Lessmann 13 cm



MD-07-770 Lessmann 17.5 cm

**MALLEABLE & DUCTILE**  
INSTRUMENTS

**08**

**Page 130-145**

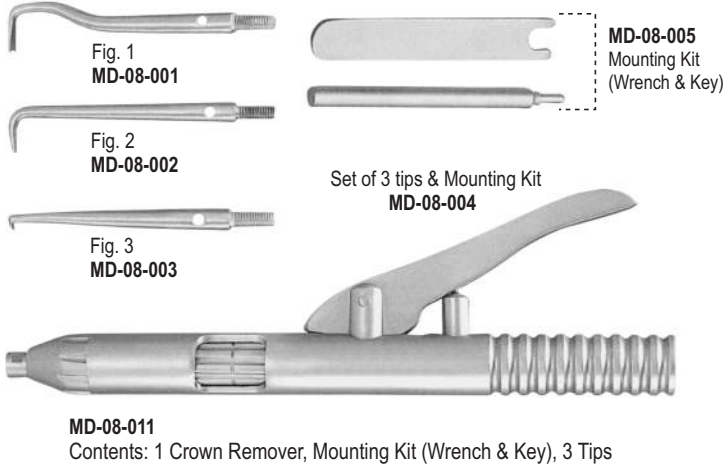
**Crown Removers**

Crown Removers & Forceps for Articulating Paper  
Crown Spreaders  
Rubber Dam Instruments  
Matrix Retainers & Rubber Dam Frames  
Ligature & Separators Placing Pliers  
Elastic Ligature Placing Forceps  
Elastic Applicators & Ligature Tuckers  
Bracket Positioning Instruments  
Bracket & Measuring Instruments  
Laboratory Instruments  
Crown Instruments & Grinding Stones  
X - Ray Holders & Laboratory Bowls

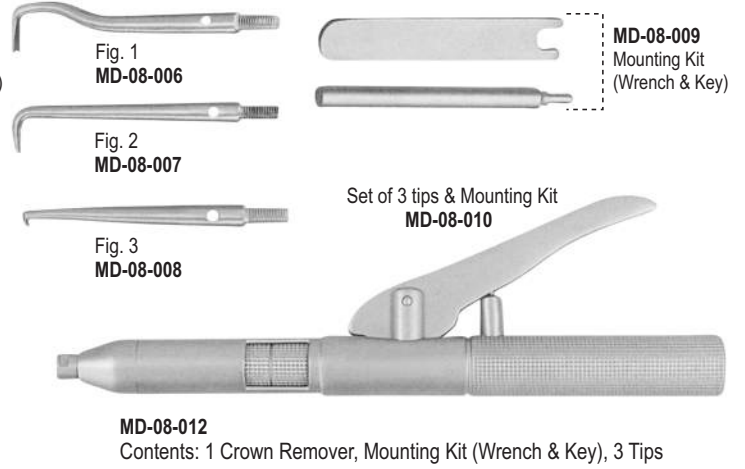




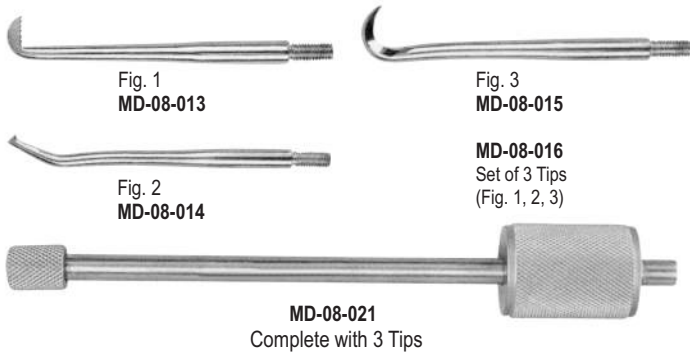
Automatic Crown & Bridge Remover



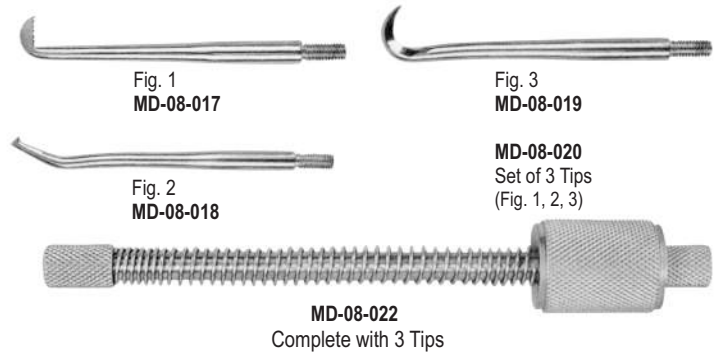
Automatic Crown & Bridge Remover



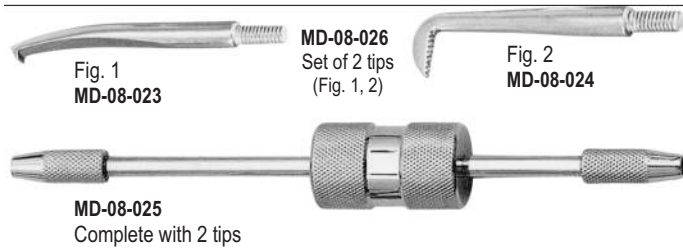
Morrel Manual Crown Remover



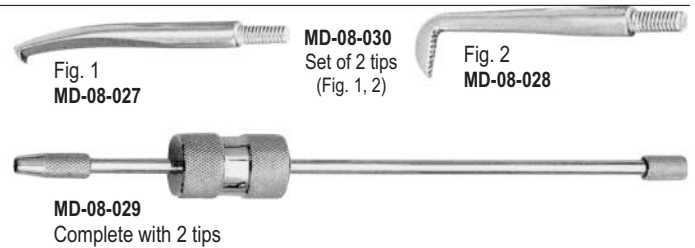
Morrel Manual Crown Remover with Spring



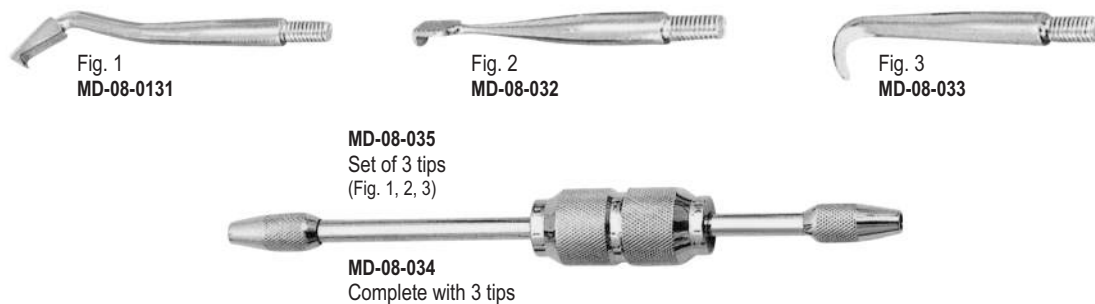
MRU manual crown remover double ended



MRU manual crown remover single ended



MRU manual crown remover double ended



**CROWN REMOVERS & CROWN SPREADERS**

Forceps For Articulating Paper

Semi-Automatic Crown & Bridge Remover

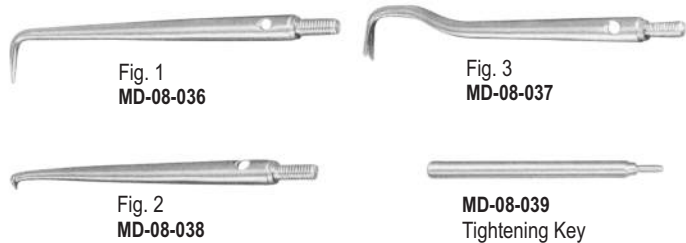


Fig. 1  
MD-08-036

Fig. 3  
MD-08-037

Fig. 2  
MD-08-038

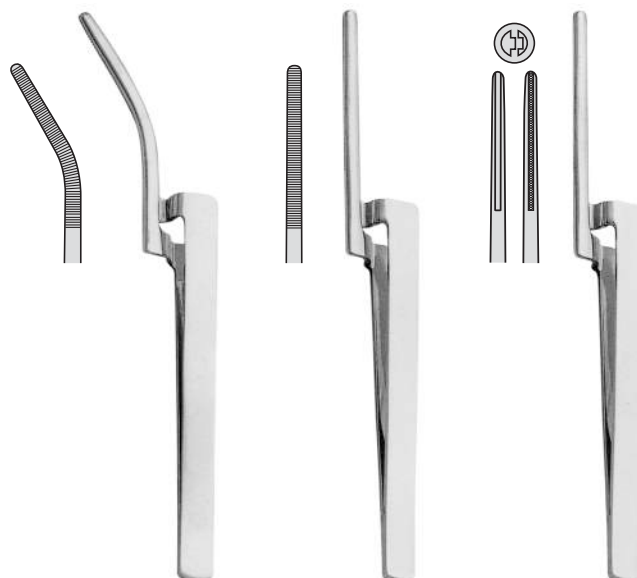
MD-08-039  
Tightening Key

Set of 3 tips & Tightening Key



MD-08-040

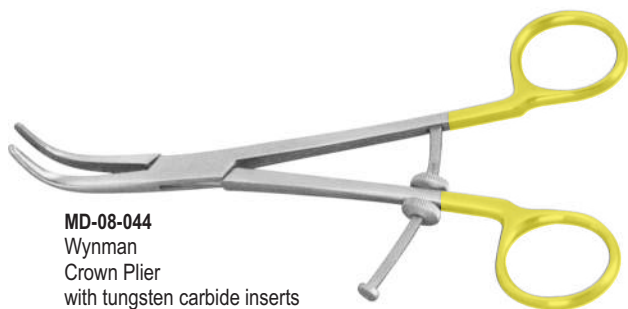
Contents: 1 Crown Remover, Tightening Key, 3 Tips



MD-08-041  
Miller  
15 cm

MD-08-042  
Miller  
15 cm

MD-08-043  
J&W  
15 cm



MD-08-044  
Wynman  
Crown Plier  
with tungsten carbide inserts



MD-08-045  
Furrer Crown Plier  
16 cm



MD-08-046  
Crown spreader



Crown Spreader



Fig. 0  
MD-08-047



Fig. 1  
MD-08-048



Fig. 2  
MD-08-049



Fig. 3  
MD-08-050  
Crown Spreader





**MD-08-051**  
Telescope Crown Plier  
13 cm



**MD-08-052**  
Telescope Crown Plier  
Fine  
15 cm



**MD-08-053**  
Telescope Crown Plier  
Diamond coated  
13 cm



**MD-08-054**  
Telescope Crown Plier  
Diamond coated  
13 cm



**MD-08-055**  
Montfort  
18 cm



**MD-08-056**  
Bohm  
16 cm



**MD-08-057**  
Upper Crown Removing



**MD-08-058**  
Lower Crown Removing



**MD-08-059**  
Upper Crown Removing



**MD-08-060**  
Lower Crown Removing

SCALER HANDLES CHOICE



**MD-08-061**  
Brewer



**MD-08-062**  
Ivory



**MD-08-063**  
Ivory  
Light Weight



**MD-08-064**  
Matrix Plier  
17 cm



**MD-08-065**  
Stokes



**MD-08-066**  
Stokes / Palmer



**MD-08-067**  
Ivory

Rubber Dam Punches



Fig.1  
**MD-08-068**  
Ainsworth



Fig.2  
**MD-08-069**  
Ainsworth



Fig. A (14,18A)  
MD-08-070  
Molars, deciduous molars & part erupted teeth.



Fig. AW (14,18A)  
MD-08-071  
Molars with good gingival retraction.



Fig. BW (4,5,8,14)  
MD-08-072  
Molars with good gingival retraction.



Fig. C (6,9,15,212)  
MD-08-073  
Incisors, canines & bicuspid.



Fig. DW (2,7)  
MD-08-074  
Small molars & large bicuspid.



Fig. E (00,0,2,2A,9,15,18A)  
MD-08-075  
All incisors, canines & premolars with limited gingival retraction.



Fig. EW (00,0,2,2A,9,15,18A)  
MD-08-076  
All incisors, canines & premolars with limited gingival retraction.



Fig. FW (14A)  
MD-08-077  
Very stable molar clamp.



Fig. G (1,2,2A)  
MD-08-078  
Small 3rd molars, deciduous molars, bicuspid & canines.



Fig. GW (1,2,2A)  
MD-08-079  
Small 3rd molars, deciduous molars, bicuspid & canines.



Fig. HW (14W)  
MD-08-080  
Extended arch version of AW.



Fig. JW (26A)  
MD-08-081  
Large molars with deep gingival fit.



Fig. K (3,4,5,7A,8,10,11,26,7,8A)  
MD-08-082  
General winged molar clamp.



Fig. L (0)  
MD-08-083  
Large jaw version of E.



Fig. M (2)  
MD-08-084  
Winged clamp for bicuspid.



Fig. NW  
MD-08-085  
Medium size molar clamp.



Fig. PW (9UW,W5)  
MD-08-086  
Large, bland molar clamp.

### Winged Premolars



Fig. 00  
MD-08-087



Fig. 0  
MD-08-088



Fig. 1  
MD-08-089



Fig. 2  
MD-08-090



Fig. 2A  
MD-08-091

### Winged Anterior



Fig. 9  
MD-08-092



Fig. 212  
MD-08-093

### Winged Molars



Fig. 7  
58-208-07



Fig. 8  
58-208-08



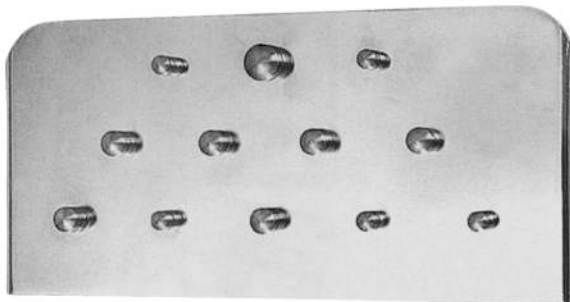
Fig. 8A  
58-208-81



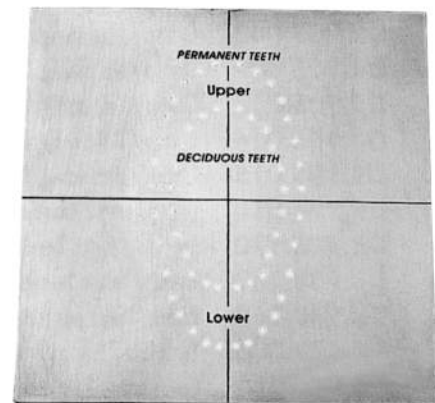
Fig. 14  
58-208-14



Fig. 14A  
58-208-14



MD-08-094  
Rubber Dam Clamps Tray



MD-08-095  
Rubber Dam Template

## MATRIX RETAINERS & RUBBER DAM FRAMES

### Matrix bands

Nystrom (Pack of 12)

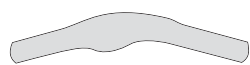


Fig. 2 MD-08-096



Fig. 4 MD-08-097

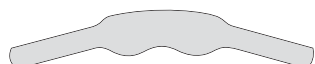


Fig. 5 MD-08-098



Fig. 6 MD-08-099



Fig. 7 MD-08-100

Ivory (Pack of 12)



Fig. 11 MD-08-101  
for children



Fig. 12 MD-08-102  
for children



Fig. 14 MD-08-103



Fig. 15 MD-08-104



Fig. 16 MD-08-105

Tofflemire (pack of 12)

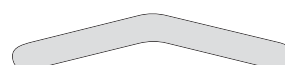


Fig. 101 MD-08-106

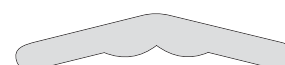


Fig. 102 MD-08-107

### Matrix Retainers



MD-08-108  
with cheek protector  
5 mm



Fig. 8  
MD-08-109  
Ivory  
5 mm



Fig. 8  
MD-08-110  
Ivory  
6 mm



Fig. 8  
MD-08-111  
Ivory  
7 mm



MD-08-112  
Tofflemire Junior



MD-08-113  
Tofflemire Senior



MD-08-114  
Tofflemire universal



MD-08-115  
Nystrom  
Left



MD-08-116  
Nystrom  
Right



Fig. 12A  
MD-08-117  
Ivory



Fig. 12  
MD-08-118  
Ivory

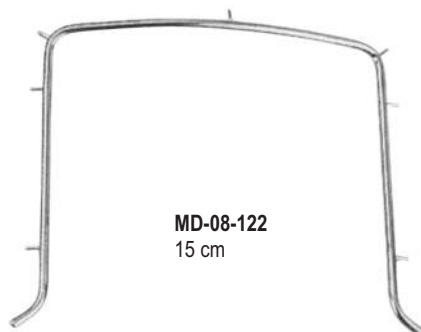


MD-08-119  
Strip clamp  
straight

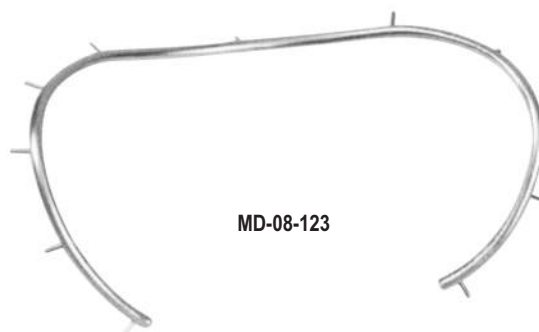
### Rubber Dam Frames



MD-08-120 13 cm  
MD-08-121 15 cm  
Young

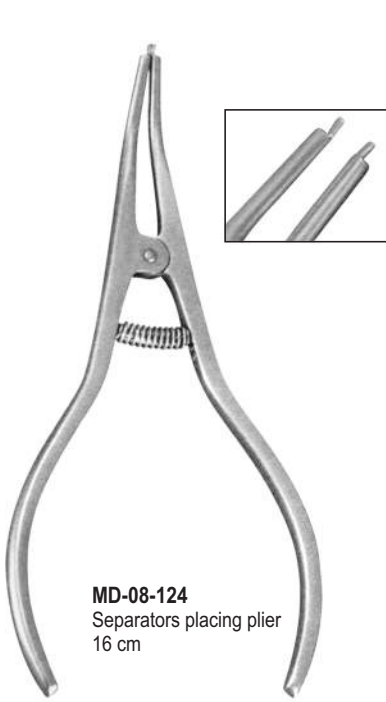


MD-08-122  
15 cm

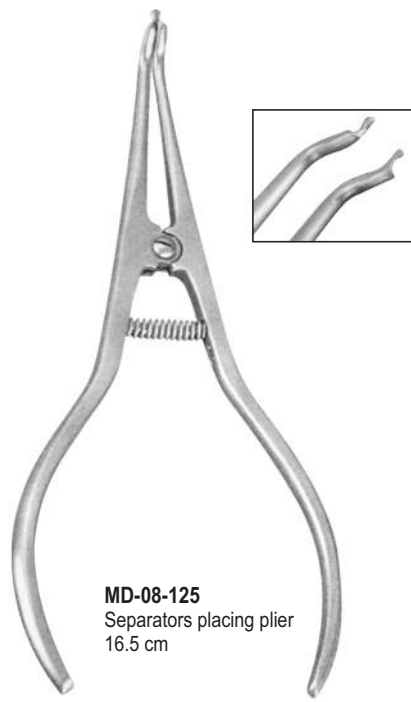


MD-08-123

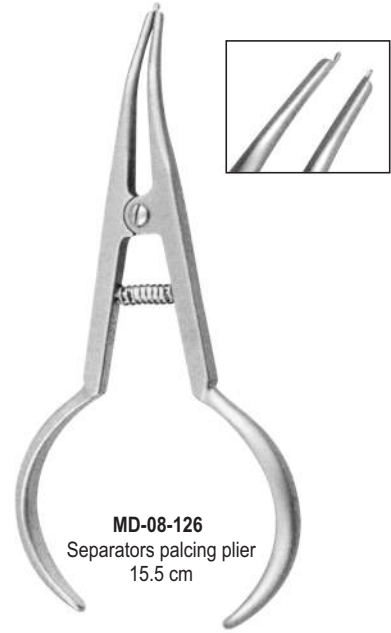




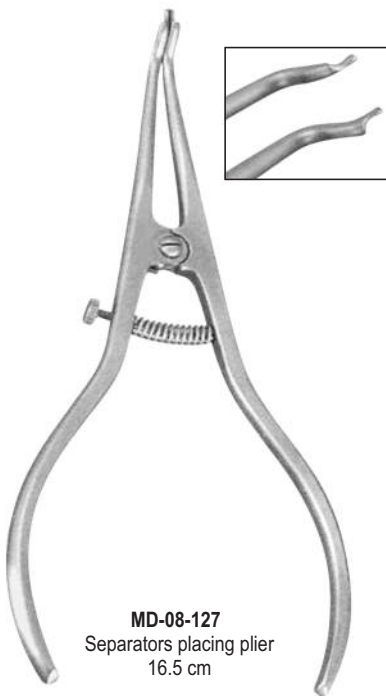
**MD-08-124**  
Separators placing plier  
16 cm



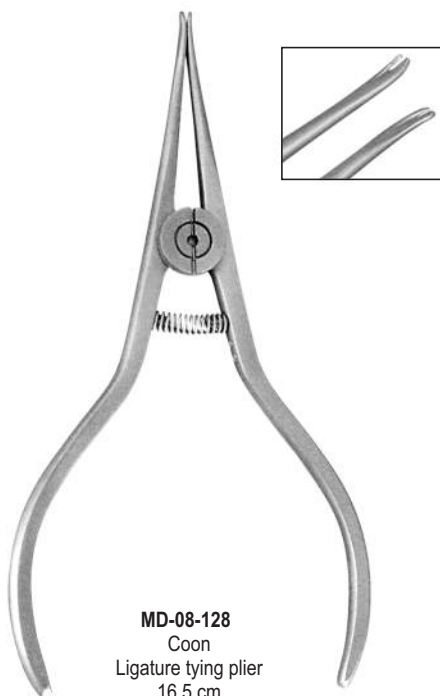
**MD-08-125**  
Separators placing plier  
16.5 cm



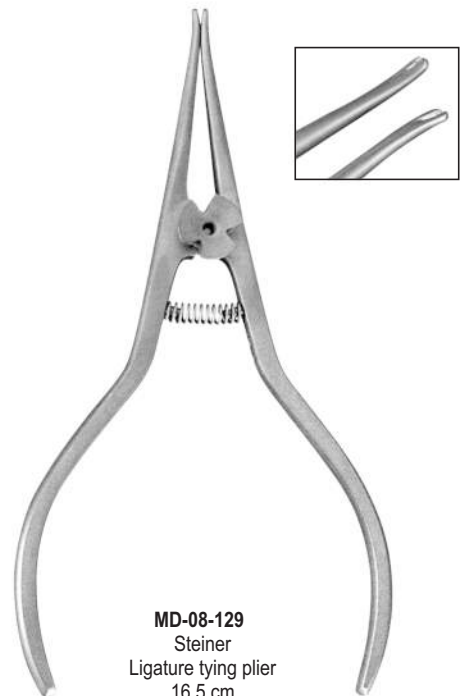
**MD-08-126**  
Separators placing plier  
15.5 cm



**MD-08-127**  
Separators placing plier  
16.5 cm

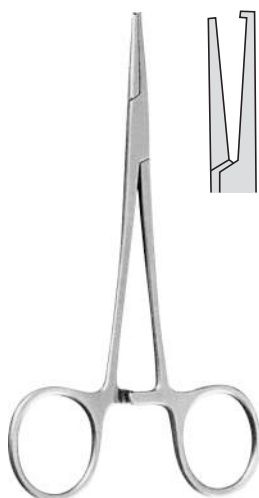


**MD-08-128**  
Coon  
Ligature tying plier  
16.5 cm

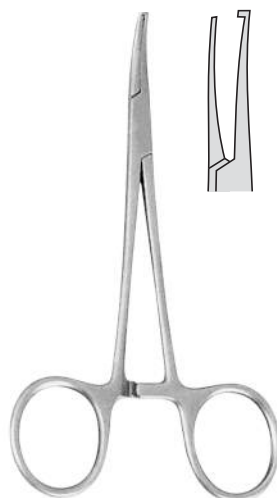


**MD-08-129**  
Steiner  
Ligature tying plier  
16.5 cm

ELASTIC LIGATURE PLACING FORCEPS



MD-08-130  
Str 12 cm



MD-08-131  
Cvd 12 cm



MD-08-132  
14 cm



MD-08-133  
12 cm



MD-08-134  
14 cm



MD-08-135  
Elastomeric ligature  
removing tweezer



Ligature plier  
14 cm

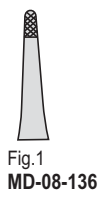


Fig.1  
MD-08-136



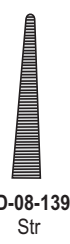
Fig.2  
MD-08-137



Fig.3  
MD-08-138



Smaha  
Ligature plier  
14 cm



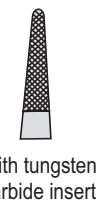
MD-08-139  
Str



MD-08-140  
Cvd



MD-08-141  
Ligature plier  
14 cm



With tungsten  
carbide insert



## ELASTIC APPLICATORS & LIGATURE TUCKERS

### Elastic Ligature Applicators

For easy placement of elastic ligatures under bracket tie wings



MD-08-142



MD-08-143

### Elastomeric Ligature Removing Instruments

Multi-purpose instruments, ligature tucker & elastomeric ligature remover



MD-08-144



MD-08-145

### Ligature Tuckers

Solid handle



MD-08-146



MD-08-147



MD-08-148



Disc safety guards set  
Protects patients gums, lips and cheeks from rotating discs



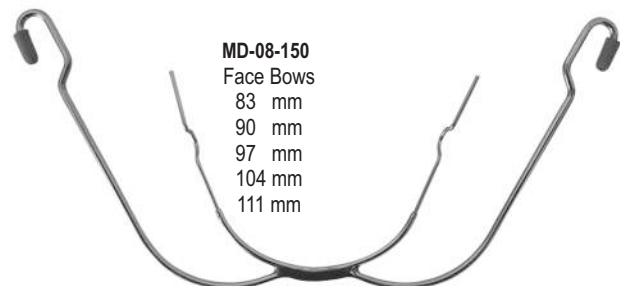
22 mm



16 mm



8 mm



MD-08-150  
Face Bows  
83 mm  
90 mm  
97 mm  
104 mm  
111 mm

**MD-08-149**  
Contents  
1 x Shaft  
1 x 8mm Guard  
1 x 16mm Guard  
1 x 22mm Guard

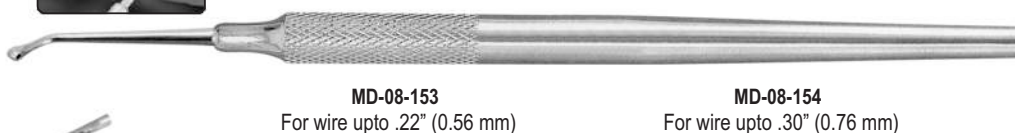
## BRACKET POSITIONING INSTRUMENTS

### Distal End Bending Instruments



**MD-08-151**  
For wire upto .22" (0.56 mm)

**MD-08-152**  
For wire upto .30" (0.76 mm)



**MD-08-153**  
For wire upto .22" (0.56 mm)

**MD-08-154**  
For wire upto .30" (0.76 mm)

### Lingual Torquing Key



**MD-08-155**

### NiTi Ice Instrument 11.5 cm



**MD-08-156**

Turns NiTi wire soft and flexible immediately for faster wire placement



### Bracket Placer for Posterior Teeth



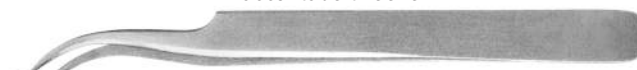
**MD-08-157**

### Reverse action buccal tube tweezer



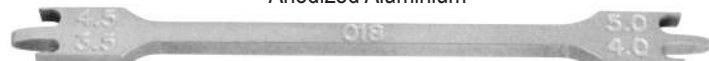
**MD-08-162** 12.5 cm  
**MD-08-163** 13.5 cm

### Buccal tube tweezer



**MD-08-164** 12 cm  
**MD-08-165** 13.5 cm  
Keat

### MRU Bracket Positioning Gauges Anodized Aluminium



**MD-08-158** For .018" slot brackets



**MD-08-159** For .022" slot brackets

### Bracket Placing Tweezers



**MD-08-166** 13.5 cm



**MD-08-167** 13.5 cm



**MD-08-168** 11 cm



**MD-08-160**

Manual interdental stipper handle

### Bracket Tweezers with Slot Aligner



**MD-08-169** 13.5 cm Fig. 1



**MD-08-170** 13.5 cm Fig. 2



**MD-08-171** 13.5 cm Fig. 3



**MD-08-161**  
Boone

Universal for both .018" or .022" slot brackets  
four different MRU for bracket positioning:  
3.5, 4, 4.5, & 5 mm Stainless Steel



BRACKET & MEASURING INSTRUMENTS



**MD-08-172**  
Band Seater 15 cm



**MD-08-173**  
Mershon band pusher 14 cm



**MD-08-174**  
Band seating



**MD-08-175**  
Molar Band Seater  
14cm

Back view

Scaler & band pushing Instruments  
(6 mm Solid Handles)



**MD-08-176** Director/Scaler



**MD-08-177** Pusher/Scaler # 300S



**MD-08-178** Ligature Director /Scaler



**MD-08-179** Ligature Director D.E



**MD-08-180** Adhesive remover

Measuring Instruments



**Bernklau MD-08-181** Orthodontic ruler  
Perfect for all diagnostic measurements,  
both intraoral and on the model



Ruler stainless steel  
**MD-08-182** 15 cm / 6"  
**MD-08-183** 30 cm / 12"



**Beerendonk MD-08-184**  
Dental vernier with long & fine tips for intraoral measurements



**J&W MD-08-185**  
Double sided, for inner & outer measurements



Orthodontic bow compass  
**MD-08-186**

Turrets  
For forming archwires, without torque,  
for wires .016" to .022" (0.41mm to 0.56mm)



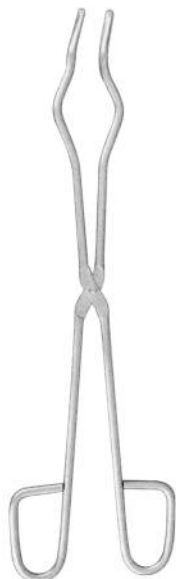
**MD-08-186**  
Made of Stainless steel



**MD-08-187**  
Made of anodized Aluminum  
Disinfectable

LABORATORY INSTRUMENTS

Furnace Tongs



**MD-08-188**  
31 cm



**MD-08-189**  
40 cm



**MD-08-190**  
56 cm



**MD-08-191** 20 cm Str  
**MD-08-192** 20 cm Cvd  
 Plaster Cutter

Calipers



Fig.1  
**MD-08-193**  
 Boley  
 Measuring range  
 0-100 mm



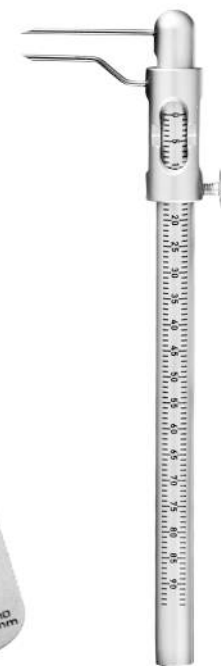
Fig.2  
**MD-08-194**  
 Boley  
 Measuring range  
 0-100 mm



**MD-08-195**  
 Iwanson for Wax  
 Measuring range  
 0-10 mm



**MD-08-196**  
 Iwanson for Metal  
 Measuring range  
 0-10 mm



**MD-08-197**  
 Micro Boley Gauge

Modeling saw & blades



MD-08-198



MD-08-199  
0.25 x 3 mm  
Pack of 12 pcs



MD-08-200  
0.25 x 5 mm  
Pack of 12 pcs



MD-08-201  
0.12 x 5 mm  
Pack of 12 pcs

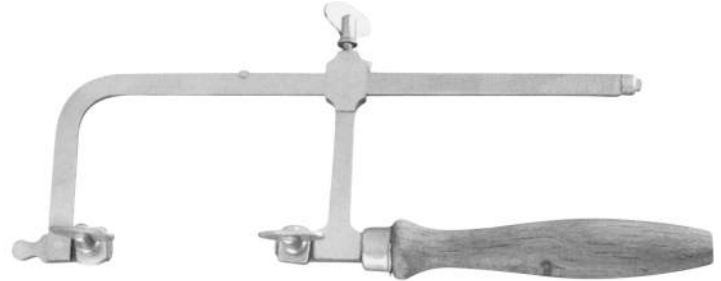


MD-08-202 Soldering Tweezer  
Str 16 cm



MD-08-203  
Soldering Tweezer  
Cvd 16 cm

Fret saw & blades



MD-08-204

MD-08-205  
Saw blades for metal  
Pack of 12 pcs

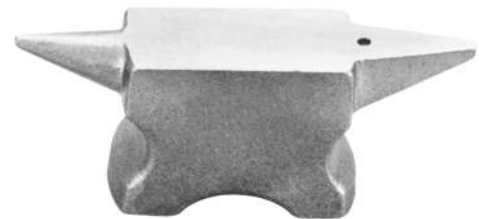
MD-08-206  
Saw blades for plaster  
Pack of 12 pcs



Fig.1  
MD-08-207  
Riveting Mallet 22 cm

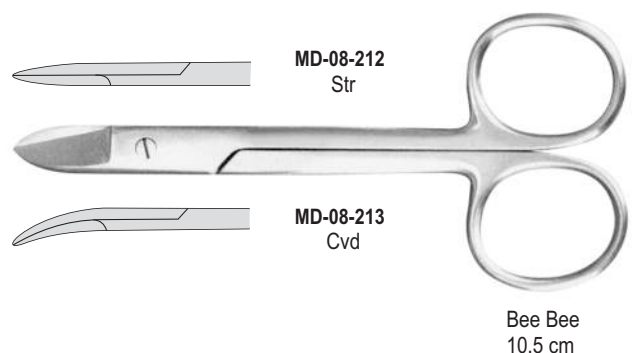
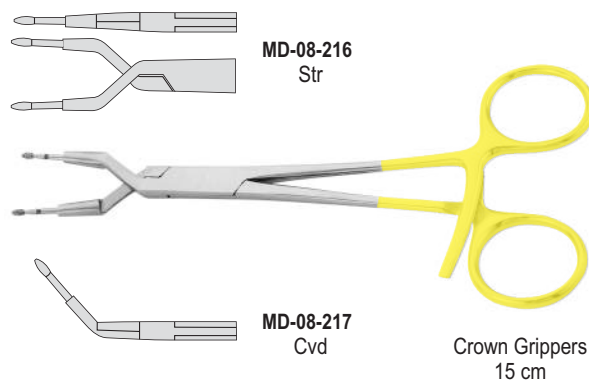
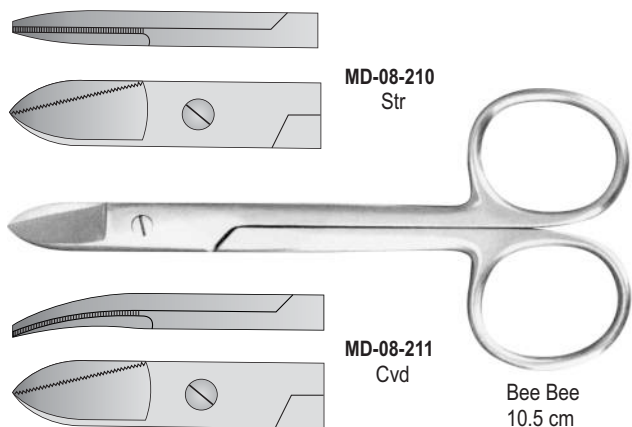


Fig.2  
MD-08-208  
Riveting Mallet 22 cm

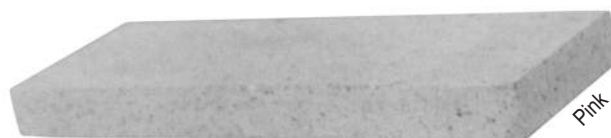


MD-08-209  
Anvil  
Carbon Steel  
L 110 x W 30 x H 40 mm

CROWN INSTRUMENTS & GRINDING STONES



Grinding stones



**MD-08-218**  
 Rectangular  
 For knives, curettes, scalers etc., medium grit, pink



**MD-08-219**  
 Taper round corners  
 For knives, curettes, scalers etc., Fine grit, white



**MD-08-220**  
 Round  
 For curettes, coarse grit, green



**MD-08-221**  
 Conical  
 For elevators & luxators, fine grit, white



### Bib chains



Fig. 1  
MD-08-222  
Ball chain



MD-08-223  
Plastic chain

### Bowls for plaster & alginate



Silicone  
Green  
MD-08-224 Ø0 cm  
MD-08-225 Ø2 cm  
MD-08-226 Ø4 cm  
MD-08-227 Ø6 cm



Polyethylene  
White  
MD-08-228 Ø10 cm  
MD-08-229 Ø12 cm  
MD-08-230 Ø14 cm

### X-Ray holders



Fig. 1  
MD-08-231



Fig. 6  
MD-08-232  
6 Clips



Fig. 10  
MD-08-233  
10 Clips

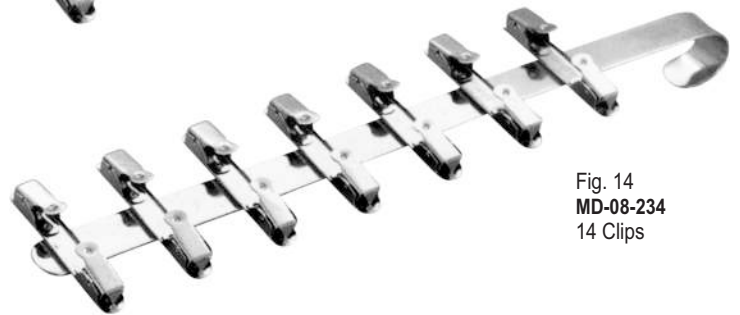


Fig. 14  
MD-08-234  
14 Clips



MD-08-235  
Bur Changer  
Square Key



MD-08-236  
Bur Changer  
Hexagonal Key

**MALLEABLE & DUCTILE**  
INSTRUMENTS

**09**

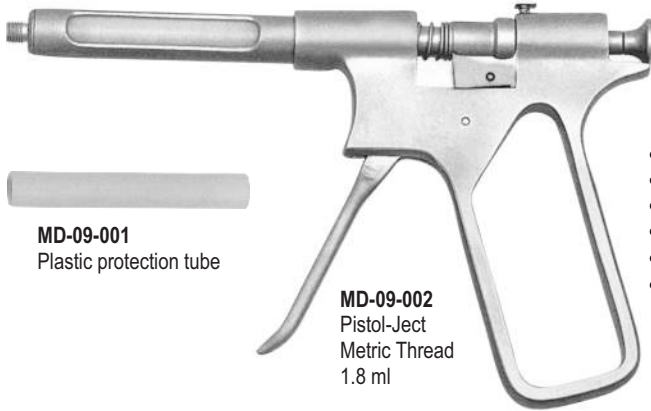
**Page 146-151**

**Dental Syringes**

Intraligamental Syringes

Self & Manual Aspirating Syringes





**MD-09-001**  
Plastic protection tube

**MD-09-002**  
Pistol-Ject  
Metric Thread  
1.8 ml

- Injects 0.02 ml with every click
- Exact dosage every time
- Lever action for high injection pressure
- Suitable for use with all 1.8 ml dental cartridges
- Made of brass, Chrome plated
- Stainless steel plungers



**MD-09-003**  
Pistol-Ject  
Metric Thread  
1.8 ml

### Disc System

#### Dual self aspiration system:

Disc system syringe has dual aspiration feature to achieve self aspiration.

#### Aspiration before injection:

Insert syringe in tissue and press Thumb disc to achieve aspiration.

#### Aspiration during injection:

Automatic aspiration occurs whenever pressure on the plunger is released.



**MD-09-004**  
Disc System  
Metric Thread  
1.8 ml

### Projection System

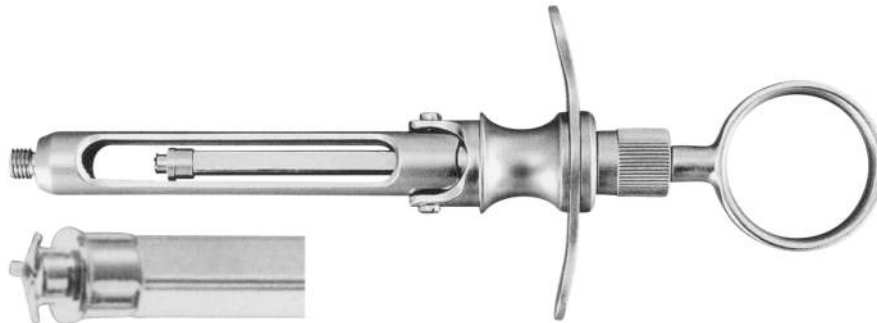
#### Aspiration during injection:

Automatic aspiration occurs whenever pressure on the plunger is released.



**MD-09-005**  
Projection System  
Metric Thread  
1.8 ml

3 movable hooks securely holds the cartridge for safe aspiration, the syringe also has self aspiration feature.



**MD-09-006**  
Trio  
Metric Thread  
1.8 ml

## INTRALIGAMENTAL SYRINGES

- Made of 18-8 stainless steel
- Longer life than brass syringes
- No chipping of chrome
- Guaranteed quality
- Sterilizable by any method

- Injects 0.05 ml with every click
- Exact dosage every time
- Supplied with angled & straight tubes
- Suitable for use with all 1.8 ml dental cartridges
- Made of stainless steel

- Injects 0.06 ml with every click
- Exact dosage every time
- Suitable for use with all 1.8 ml dental cartridges
- Made of stainless Steel

- Injects 0.06 ml with every click
- Exact dosage every time
- Suitable for use with all 1.8 ml dental cartridges
- Made of stainless Steel

- Injects 0.06 ml with every click
- Exact dosage every time
- Suitable for use with all 1.8 ml dental cartridges
- Made of stainless Steel

- Fully autoclaveable
- Removeable head piece with angled threaded nozzle for the injection needle.
- Viewing chamber with safety sleeve for carpule eartridge.
- Colour coated
- Also available in original Steel colour.



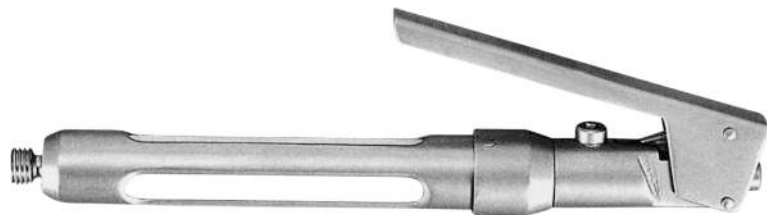
**MD-09-007**  
Metric Thread  
1.8 ml



**MD-09-008**  
Angled  
Metric Thread  
1.8 ml



**MD-09-009**  
Straight  
Metric Thread  
1.8 ml



**MD-09-010**  
Swedish Type  
Metric Thread  
1.8 ml



**MD-09-011**  
Intraligamental  
Syringe  
1.8 ml



## SELF &amp; MANUAL ASPIRATING SYRINGES



**MD-09-012**  
Type - A  
Metric Thread  
1.8 ml

Dual aspiration system  
Self and manual aspirating syringes  
During injection aspiration can be achieved either manually by retracting the plunger backward or simply releasing pressure on plunger will produce self aspiration.



**MD-09-013**  
Type - C  
Metric Thread  
1.8 ml

## Manual Aspirating Syringes



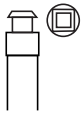
**MD-09-014**  
Type - A  
Metric Thread  
1.8 ml



**MD-09-015**  
Type - C  
Metric Thread  
1.8 ml



**MD-09-016**  
P - Ject  
Metric Thread  
1.8 ml



Special aspiration tip for use with  
1.8 ml cartridges with hole.  
(May also be used with traditional  
cartridges. (without aspiration).



**MD-09-017**  
Type - A  
Metric Thread  
1.8 ml

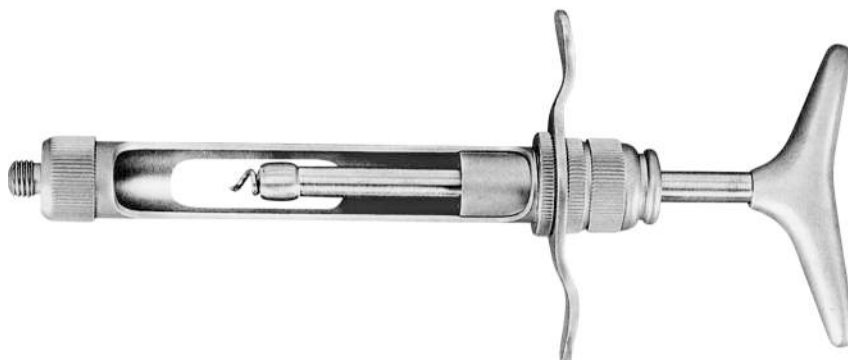


**MD-09-018**  
Euro  
Metric Thread  
1.8 ml

MANUAL ASPIRATING SYRINGES



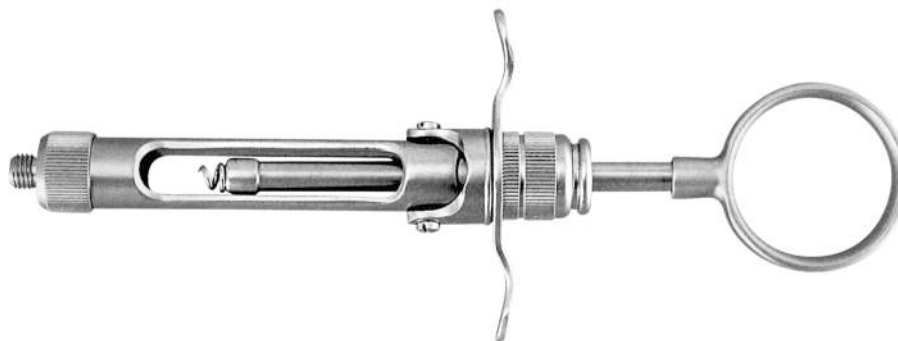
**MD-09-019**  
 Euro  
 Metric Thread  
 1.8 ml



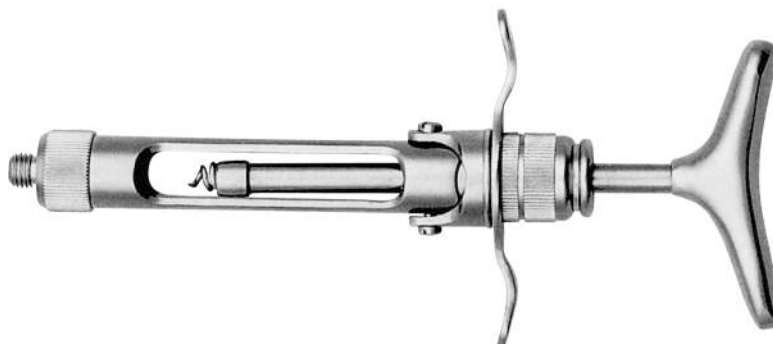
**MD-09-020**  
 T - Handle  
 Metric Thread  
 1.8 ml



**MD-09-021**  
 3 - Ring  
 Metric Thread  
 1.8 ml



**MD-09-022**  
 Euro breech loading, Ring handle  
 Metric Thread  
 1.8 ml



**MD-09-023**  
 Euro breech loading, T - handle  
 Metric Thread  
 1.8 ml



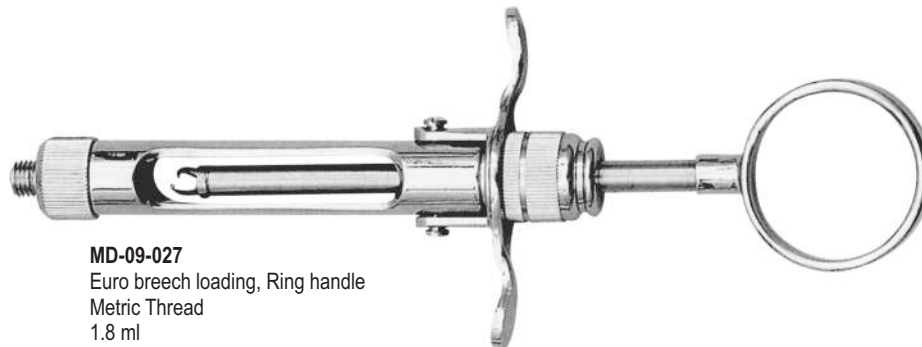
**MD-09-024**  
Euro  
Metric Thread  
1.8 ml



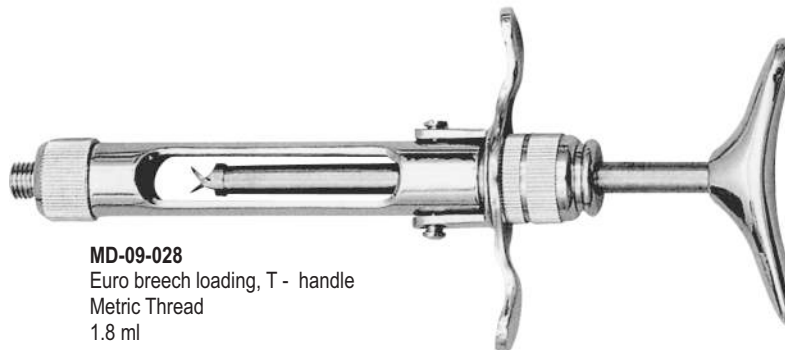
**MD-09-025**  
3 - Ring  
Metric Thread  
1.8 ml



**MD-09-026**  
2 - Ring  
Metric Thread  
1.8 ml



**MD-09-027**  
Euro breech loading, Ring handle  
Metric Thread  
1.8 ml



**MD-09-028**  
Euro breech loading, T - handle  
Metric Thread  
1.8 ml

**MALLEABLE & DUCTILE**  
INSTRUMENTS

**10**

**Page 152-157**

**Impression Trays**

Impression Trays (Solid & Perforated)







## PARTIAL IMPRESSION TRAYS FOR CROWN & BRIDGE WORK

Made of High Quality Non-Magnetic Stainless Steel (AISI 304). Micro Etched Inner Surface For Better Retention

Blue Clear Green Red Purple Yellow

### Perforated with Rim



Fig. 30  
MD-10-001  
Upper Left / Lower Right

Fig. 31  
MD-10-002  
Lower Left / Upper Right

Fig. 32  
MD-10-003  
Lower Jaw

Fig. 33  
MD-10-004  
Upper Jaw

Fig. 99  
MD-10-005  
Lateral

### Solid with Rim



Fig. 30  
MD-10-006  
Upper Left / Lower Right

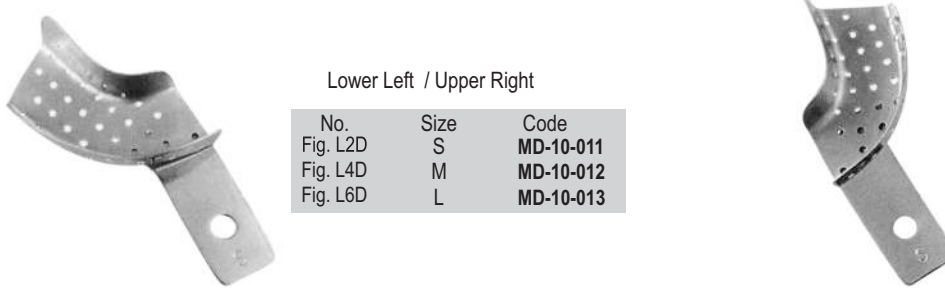
Fig. 31  
MD-10-007  
Lower Left / Upper Right

Fig. 32  
MD-10-008  
Lower Jaw

Fig. 33  
MD-10-009  
Upper Jaw

Fig. 99  
MD-10-010  
Lateral

### Perforated without Rim



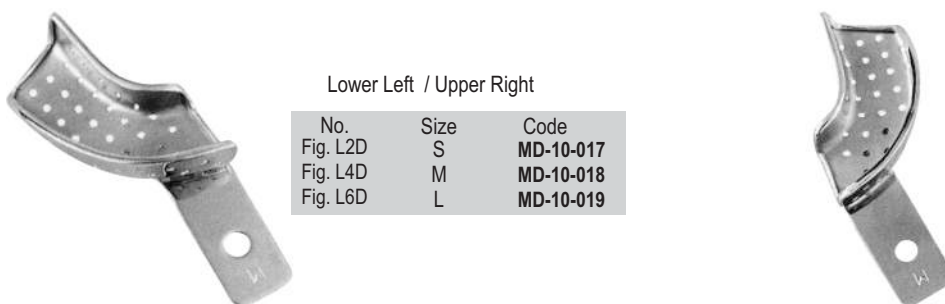
Lower Left / Upper Right

No.	Size	Code
Fig. L2D	S	MD-10-011
Fig. L4D	M	MD-10-012
Fig. L6D	L	MD-10-013

Upper Left / Lower Right

No.	Size	Code
Fig. L2S	S	MD-10-014
Fig. L4S	M	MD-10-015
Fig. L6S	L	MD-10-016

### Perforated with Rim



Lower Left / Upper Right

No.	Size	Code
Fig. L2D	S	MD-10-017
Fig. L4D	M	MD-10-018
Fig. L6D	L	MD-10-019

Upper Left / Lower Right

No.	Size	Code
Fig. L2S	S	MD-10-020
Fig. L4S	M	MD-10-021
Fig. L6S	L	MD-10-022

## IMPRESSION TRAYS REGULAR

Made of High Quality Non-Magnetic Stainless Steel (AISI 304). Micro Etched Inner Surface For Better Retention

Silicone buttons for impression trays  
Fit any impression tray. Easy identification of size

### Perforated without Rim



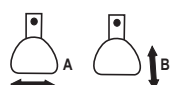
Lower



No.	Size	A mm	B mm	Code
L1	XXS	55	47	MD-10-023
L2	XS	60	49	MD-10-024
L3	S	72	54	MD-10-025
L4	M	74	57	MD-10-026
L5	L	76	59	MD-10-027
L6	XL	78	61	MD-10-028



Upper



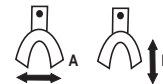
No.	Size	A mm	B mm	Code
U1	XXS	61	47	MD-10-029
U2	XS	64	51	MD-10-030
U3	S	66	53	MD-10-031
U4	M	69	57	MD-10-032
U5	L	71	60	MD-10-033
U6	XL	73	62	MD-10-034

Set	Contents	Code
6 Pcs	L3,L4,L5,U3,U4,U5	MD-10-035
8 Pcs	L3,L4,L5,L6,U3,U4,U5,U6	MD-10-036
12 Pcs	L1,L2,L3,L4,L5,L6 U1,U2,U3,U4,U5,U6	MD-10-037

### Perforated with Rim



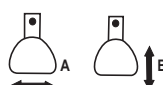
Lower



No.	Size	A mm	B mm	Code
L1	XXS	55	47	MD-10-053
L2	XS	60	49	MD-10-054
L3	S	72	54	MD-10-055
L4	M	74	57	MD-10-056
L5	L	76	59	MD-10-057
L6	XL	78	61	MD-10-058



Upper



No.	Size	A mm	B mm	Code
U1	XXS	61	47	MD-10-059
U2	XS	64	51	MD-10-060
U3	S	66	53	MD-10-061
U4	M	69	57	MD-10-062
U5	L	71	60	MD-10-063
U6	XL	73	62	MD-10-064

Set	Contents	Code
6 Pcs	L3,L4,L5,U3,U4,U5	MD-10-065
8 Pcs	L3,L4,L5,L6,U3,U4,U5,U6	MD-10-066
12 Pcs	L1,L2,L3,L4,L5,L6 U1,U2,U3,U4,U5,U6	MD-10-067

### Solid without Rim



Lower



No.	Size	A mm	B mm	Code
L1	XXS	55	47	MD-10-038
L2	XS	60	49	MD-10-039
L3	S	72	54	MD-10-040
L4	M	74	57	MD-10-041
L5	L	76	59	MD-10-042
L6	XL	78	61	MD-10-043



Upper



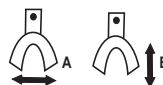
No.	Size	A mm	B mm	Code
U1	XXS	61	47	MD-10-044
U2	XS	64	51	MD-10-045
U3	S	66	53	MD-10-046
U4	M	69	57	MD-10-047
U5	L	71	60	MD-10-048
U6	XL	73	62	MD-10-049

Set	Contents	Code
6 Pcs	L3,L4,L5,U3,U4,U5	MD-10-050
8 Pcs	L3,L4,L5,L6,U3,U4,U5,U6	MD-10-051
12 Pcs	L1,L2,L3,L4,L5,L6 U1,U2,U3,U4,U5,U6	MD-10-052

### Solid with Rim



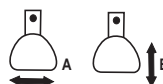
Lower



No.	Size	A mm	B mm	Code
L1	XXS	55	47	MD-10-068
L2	XS	60	49	MD-10-069
L3	S	72	54	MD-10-070
L4	M	74	57	MD-10-071
L5	L	76	59	MD-10-072
L6	XL	78	61	MD-10-073



Upper



No.	Size	A mm	B mm	Code
U1	XXS	61	47	MD-10-074
U2	XS	64	51	MD-10-075
U3	S	66	53	MD-10-076
U4	M	69	57	MD-10-077
U5	L	71	60	MD-10-078
U6	XL	73	62	MD-10-079

Set	Contents	Code
6 Pcs	L3,L4,L5,U3,U4,U5	MD-10-080
8 Pcs	L3,L4,L5,L6,U3,U4,U5,U6	MD-10-081
12 Pcs	L1,L2,L3,L4,L5,L6 U1,U2,U3,U4,U5,U6	MD-10-082

Made of High Quality Non-Magnetic Stainless Steel (AISI 304).  
Micro Etched Inner Surface For Better Retention

### Perforated with Rim



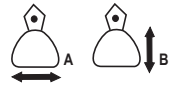
Lower



Upper



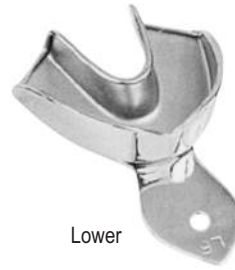
No.	Size	A mm	B mm	Code
L1	XL	80	63	MD-10-083
L2	L	78	59	MD-10-084
L3	M	76	57	MD-10-085
L4	NM	72	57	MD-10-086
L5	S	69	50	MD-10-087



No.	Size	A mm	B mm	Code
U1	XL	81	63	MD-10-088
U2	L	74	60	MD-10-089
U3	M	71	55	MD-10-090
U4	NM	67	53	MD-10-091
U5	S	65	51	MD-10-092

Set	Contents	Code
6 Pcs	L2,L3,L4,U2,U3,U4	MD-10-093
10 Pcs	L1,L2,L3,L4,L5 U1,U2,U3,U4,U5	MD-10-094

### Impression Trays Regular

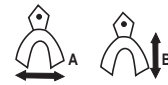


Lower

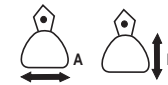


Upper

### Solid with Rim



No.	Size	A mm	B mm	Code
L1	XL	80	63	MD-10-108
L2	L	78	59	MD-10-109
L3	M	76	57	MD-10-110
L4	NM	72	57	MD-10-111
L5	S	69	50	MD-10-112



No.	Size	A mm	B mm	Code
U1	XL	81	63	MD-10-113
U2	L	74	60	MD-10-114
U3	M	71	55	MD-10-115
U4	NM	67	53	MD-10-116
U5	S	65	51	MD-10-117

Set	Contents	Code
6 Pcs	L2,L3,L4,U2,U3,U4	MD-10-118
10 Pcs	L1,L2,L3,L4,L5 U1,U2,U3,U4,U5	MD-10-119

### Impression Trays For Children

#### Perforated with Rim



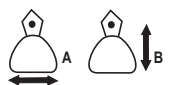
Lower



Upper



No.	Size	A mm	B mm	Code
L1	S	54	47	MD-10-095
L2	M	62	51	MD-10-096
L3	L	70	55	MD-10-097



No.	Size	A mm	B mm	Code
U1	S	55	43	MD-10-098
U2	M	60	45	MD-10-099
U3	L	63	49	MD-10-100

Set	Contents	Code
6 Pcs	L1,L2,L3,U1,U2,U3	MD-10-101



Lower

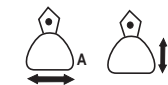


Upper

#### Solid with Rim



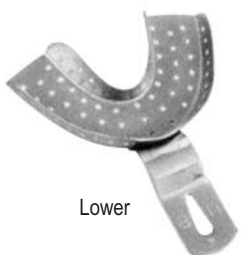
No.	Size	A mm	B mm	Code
L1	S	54	47	MD-10-120
L2	M	62	51	MD-10-121
L3	L	70	55	MD-10-122



No.	Size	A mm	B mm	Code
U1	S	55	43	MD-10-123
U2	M	60	45	MD-10-124
U3	L	63	49	MD-10-125

Set	Contents	Code
6 Pcs	L1,L2,L3,U1,U2,U3	MD-10-126

### Impression Trays Regular Ehrlicke Pattern Perforated



Lower

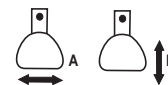


No.	Size	A mm	B mm	Code
Ub0	XS	65	46	MD-10-102
UB1	S	67	50	MD-10-103
UB2	M	76	54	MD-10-104
UB3	L	79	56	MD-10-105
UB4	XL	79	61	MD-10-106

Set	Contents	Code
10 Pcs	UB0,UB1,UB2,UB3,UB4, OB0,OB1,OB2,OB3,OB4	MD-10-107



Upper



No.	Size	A mm	B mm	Code
OB0	XS	59	52	MD-10-127
OB1	S	66	52	MD-10-128
OB2	M	71	62	MD-10-129
OB3	L	71	64	MD-10-130
OB4	XL	80	70	MD-10-131

Set	Contents	Code
10 Pcs	UB0,UB1,UB2,UB3,UB4, OB0,OB1,OB2,OB3,OB4	MD-10-132

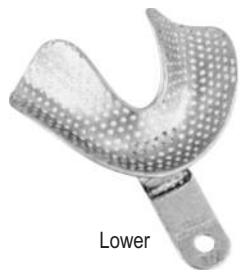
## IMPRESSION TRAYS

Made of High Quality Non-Magnetic Stainless Steel (AISI 304).  
Micro Etched Inner Surface For Better Retention

Perforated with Rim

Impression Trays Edentulous

Solid with Rim



Lower



No.	Size	A mm	B mm	Code
L1	XL	84	65	MD-10-133
L2	L	77	64	MD-10-134
L3	M	76	60	MD-10-135
L4	S	68	57	MD-10-136



Lower



No.	Size	A mm	B mm	Code
L1	XL	84	65	MD-10-152
L2	L	77	64	MD-10-153
L3	M	76	60	MD-10-154
L4	S	68	57	MD-10-155



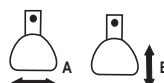
Upper



No.	Size	A mm	B mm	Code
U1	XL	80	62	MD-10-137
U2	L	77	60	MD-10-138
U3	M	70	60	MD-10-139
U4	S	72	56	MD-10-140



Upper



No.	Size	A mm	B mm	Code
U1	XL	80	62	MD-10-156
U2	L	77	60	MD-10-157
U3	M	70	60	MD-10-158
U4	S	72	56	MD-10-159

Set	Contents	Code
8 Pcs	L1,L2,L3,L4,U1,U2,U3,U4	MD-10-141

Set	Contents	Code
8 Pcs	L1,L2,L3,L4,U1,U2,U3,U4	MD-10-160

Perforated with Rim

Impression Trays Anterior Depressed

Solid with Rim



Lower



No.	Size	A mm	B mm	Code
L1	S	65	48	MD-10-142
L2	M	72	57	MD-10-143
L3	L	75	57	MD-10-144



Lower



No.	Size	A mm	B mm	Code
L1	S	65	48	MD-10-161
L2	M	72	57	MD-10-162
L3	L	75	57	MD-10-163



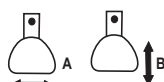
Upper



No.	Size	A mm	B mm	Code
U1	S	64	56	MD-10-145
U2	M	67	60	MD-10-146
U3	L	72	63	MD-10-147



Upper



No.	Size	A mm	B mm	Code
U1	S	64	56	MD-10-164
U2	M	67	60	MD-10-165
U3	L	72	63	MD-10-166

Set	Contents	Code
6 Pcs	L1,L2,L3,U1,U2,U3	MD-10-148

Set	Contents	Code
6 Pcs	L1,L2,L3,U1,U2,U3	MD-10-167

Impression Trays Edentulous Ehrlicke Pattern Perforated



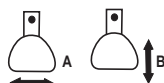
Lower



No.	Size	A mm	B mm	Code
UU1	S	70	48	MD-10-149
UU2	M	70	53	MD-10-150
UU3	L	72	57	MD-10-151



Upper

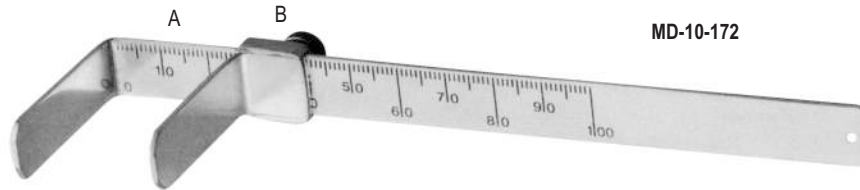


No.	Size	A mm	B mm	Code
OU1	S	64	46	MD-10-168
OU2	M	68	53	MD-10-169
OU3	L	79	61	MD-10-170

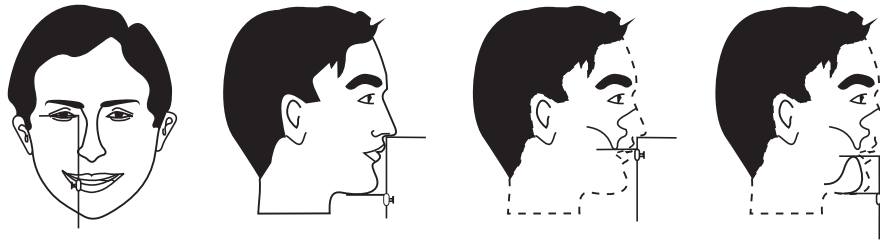
Set	Contents	Code
6 Pcs	UU1,UU2,UU3,OU1,OU2,OU3	MD-10-171

### Bite Gauge

A simple measuring instrument as an aid in the re-establishment of correct facial contour during full or partial denture work.



Slide B is fully adjustable and reversible along shaft A and may be fixed at any position by means of its locking-screw as shown.



### Carvers for silicone impression materials



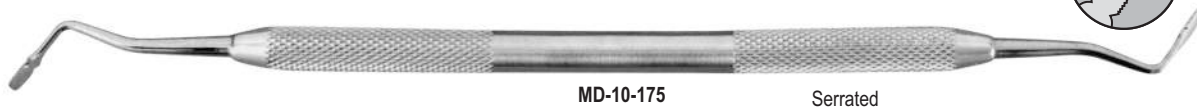
MD-10-173

Hollow handle



MD-10-174

### Gingival cord packers



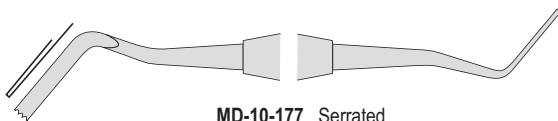
MD-10-175

Serrated

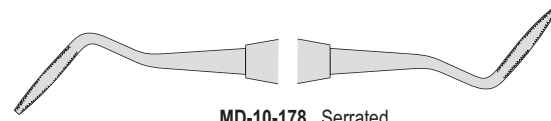


MD-10-176

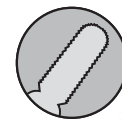
Smooth



MD-10-177 Serrated



MD-10-178 Serrated



**MALLEABLE & DUCTILE**  
INSTRUMENTS

11

Page 158-169

## Instruments Trays

Instruments Trays

Instruments Boxes

Sterilizing Boxes & Tray

Instruments Trays & Accessories For Burs

Spirit Lamps & Jars

Urinals, Bed Pans & Sterilizing Drums





Instruments Trays

<b>MD-11-001</b>	210 x 160 x 10 mm
<b>MD-11-002</b>	240 x 180 x 10 mm
<b>MD-11-003</b>	310 x 150 x 10 mm
<b>MD-11-004</b>	310 x 210 x 10 mm
<b>MD-11-005</b>	350 x 240 x 10 mm
<b>MD-11-006</b>	400 x 270 x 10 mm
<b>MD-11-007</b>	420 x 280 x 10 mm

Mayo Trays Perforated

<b>MD-11-008</b>	150 x 100 x 50 mm
<b>MD-11-009</b>	200 x 100 x 50 mm
<b>MD-11-010</b>	220 x 120 x 50 mm
<b>MD-11-011</b>	240 x 140 x 50 mm
<b>MD-11-012</b>	200 x 150 x 50 mm
<b>MD-11-013</b>	250 x 200 x 50 mm
<b>MD-11-014</b>	300 x 200 x 50 mm
<b>MD-11-015</b>	300 x 250 x 50 mm
<b>MD-11-016</b>	350 x 250 x 50 mm
<b>MD-11-017</b>	400 x 300 x 50 mm
<b>MD-11-018</b>	450 x 300 x 50 mm
<b>MD-11-019</b>	450 x 350 x 50 mm



DIN Baskets perforated sides

<b>MD-11-020</b>	240 x 240 x 50 mm
<b>MD-11-021</b>	240 x 240 x 100 mm
<b>MD-11-022</b>	480 x 260 x 50 mm
<b>MD-11-023</b>	520 x 260 x 80 mm
<b>MD-11-024</b>	520 x 260 x 100 mm

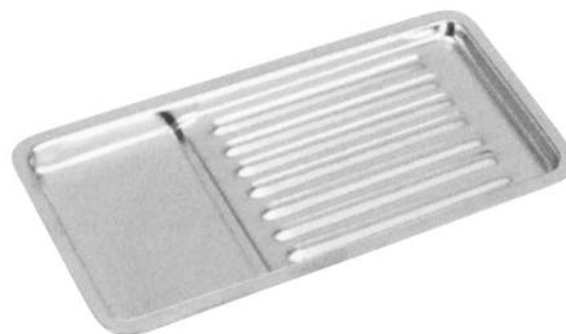
Wiremesh Baskets perforated

<b>MD-11-025</b>	240 x 240 x 50 mm
<b>MD-11-026</b>	260 x 240 x 100 mm
<b>MD-11-027</b>	480 x 260 x 50 mm
<b>MD-11-028</b>	520 x 260 x 80 mm
<b>MD-11-029</b>	520 x 260 x 100 mm

## INSTRUMENTS TRAYS



Scalers Trays	
MD-11-030	190 x 100 x 17 mm
MD-11-031	200 x 100 x 25 mm



Scalers Trays	
MD-11-032	185 x 80 x 15 mm

MD-11-041



Instruments Trays With LID	
MD-11-033	150 x 100 x 50 mm
MD-11-034	200 x 100 x 50 mm
MD-11-035	220 x 120 x 50 mm
MD-11-036	240 x 140 x 50 mm
MD-11-037	200 x 150 x 50 mm
MD-11-038	250 x 200 x 50 mm
MD-11-039	300 x 250 x 50 mm
MD-11-040	300 x 200 x 50 mm
MD-11-041	350 x 250 x 50 mm
MD-11-042	400 x 300 x 50 mm
MD-11-043	450 x 300 x 50 mm
MD-11-044	450 x 350 x 50 mm



Instruments Trays Without LID	
MD-11-045	150 x 100 x 50 mm
MD-11-046	200 x 100 x 50 mm
MD-11-047	220 x 120 x 50 mm
MD-11-048	240 x 140 x 50 mm
MD-11-049	200 x 150 x 50 mm
MD-11-050	250 x 200 x 50 mm
MD-11-051	300 x 250 x 50 mm
MD-11-052	300 x 200 x 50 mm
MD-11-053	350 x 250 x 50 mm
MD-11-054	400 x 300 x 50 mm
MD-11-055	450 x 300 x 50 mm
MD-11-056	450 x 350 x 50 mm





Instrument Boxes With Side Handle

MD-11-057	150 x 100 x 50 mm
MD-11-058	200 x 100 x 50 mm
MD-11-059	220 x 120 x 50 mm
MD-11-060	240 x 140 x 50 mm
MD-11-061	200 x 150 x 50 mm
MD-11-062	250 x 200 x 50 mm
MD-11-063	300 x 200 x 50 mm
MD-11-064	300 x 250 x 50 mm
MD-11-065	400 x 300 x 50 mm
MD-11-066	450 x 300 x 50 mm
MD-11-067	450 x 350 x 50 mm



Instrument Boxes With LID

MD-11-068	150 x 100 x 50 mm
MD-11-069	200 x 100 x 50 mm
MD-11-070	220 x 120 x 50 mm
MD-11-071	240 x 140 x 50 mm
MD-11-072	200 x 150 x 50 mm
MD-11-073	250 x 200 x 50 mm
MD-11-074	300 x 200 x 50 mm
MD-11-075	300 x 250 x 50 mm
MD-11-076	400 x 300 x 50 mm
MD-11-077	400 x 300 x 50 mm
MD-11-078	450 x 350 x 50 mm



Perforated Instruments Boxes

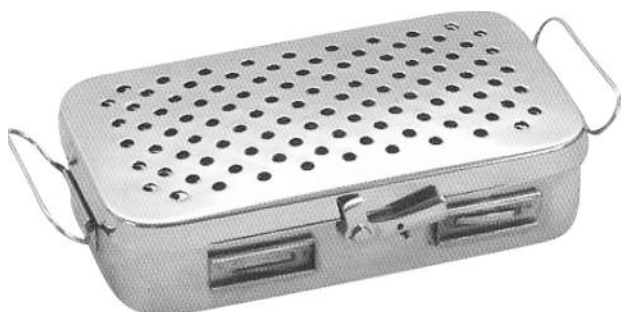
MD-11-079	170 x 070 x 35 mm
MD-11-080	180 x 080 x 40 mm
MD-11-081	200 x 100 x 40 mm
MD-11-082	200 x 100 x 50 mm
MD-11-083	200 x 100 x 60 mm
MD-11-084	220 x 120 x 60 mm
MD-11-085	250 x 120 x 60 mm
MD-11-086	300 x 150 x 60 mm
MD-11-087	300 x 200 x 80 mm
MD-11-088	400 x 160 x 80 mm
MD-11-089	400 x 200 x 100 mm
MD-11-090	500 x 200 x 120 mm



Perforated Instruments Boxes

MD-11-091	170 x 070 x 35 mm
MD-11-092	180 x 080 x 40 mm
MD-11-093	200 x 100 x 40 mm
MD-11-094	200 x 100 x 50 mm
MD-11-095	200 x 100 x 60 mm
MD-11-096	220 x 120 x 60 mm
MD-11-097	250 x 120 x 60 mm
MD-11-098	300 x 150 x 60 mm
MD-11-099	300 x 200 x 80 mm
MD-11-100	400 x 160 x 80 mm
MD-11-101	400 x 200 x 100 mm
MD-11-102	500 x 200 x 120 mm

## STERILIZING BOXES & INSTRUMENTS TRAY



Instruments Boxes Perforated

MD-11-103	180 x 80 x 30 mm
MD-11-104	180 x 80 x 40 mm
MD-11-105	180 x 80 x 50 mm
MD-11-106	200 x 90 x 30 mm
MD-11-107	200 x 90 x 40 mm
MD-11-108	200 x 90 x 50 mm
MD-11-109	250 x 100 x 40 mm
MD-11-110	250 x 100 x 50 mm
MD-11-111	250 x 100 x 60 mm



Catheter trays with cover

MD-11-112	100 x 200 x 50 mm
MD-11-113	100 x 300 x 50 mm
MD-11-114	120 x 220 x 50 mm



Instruments Boxes With Filters

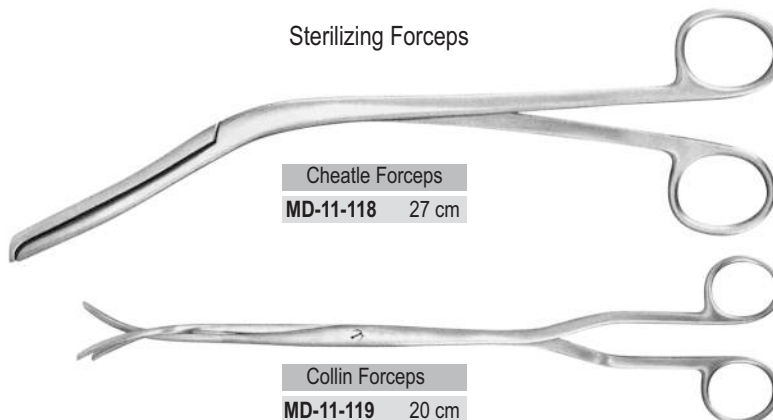
MD-11-115	170 x 070 x 35 mm
MD-11-116	180 x 080 x 40 mm
MD-11-117	200 x 100 x 40 mm
MD-11-118	200 x 100 x 50 mm
MD-11-119	200 x 100 x 60 mm
MD-11-110	220 x 120 x 60 mm
MD-11-111	250 x 120 x 60 mm
MD-11-112	300 x 150 x 60 mm
MD-11-113	300 x 200 x 80 mm
MD-11-114	400 x 160 x 80 mm
MD-11-115	400 x 200 x 100 mm
MD-11-116	500 x 200 x 120 mm



Thermometer Jar

	dia. height
MD-11-117	Ø 25 x 100 mm

Sterilizing Forceps

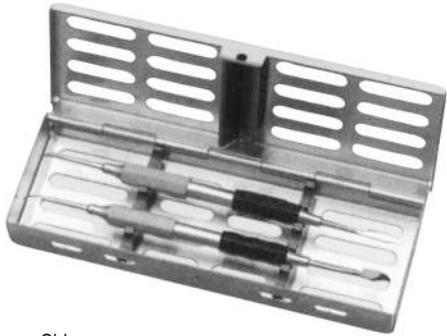


Cheatle Forceps

MD-11-118	27 cm
-----------	-------

Collin Forceps

MD-11-119	20 cm
MD-11-120	30 cm



Chico

Stainless Steel for 5 instruments

**MD-11-121** 180 x 60 x 22 mm



Medio

Stainless Steel for 10 instruments

**MD-11-122** 180 x 125 x 22 mm



Maxi

Stainless Steel for 20 instruments

**MD-11-123** 280 x 180 x 25 mm



Maxi Set 1

Stainless Steel rack for 15 instruments

**MD-11-124** 288 x 187 x 40 mm



Maxi Set 2

Stainless Steel for 15 instruments

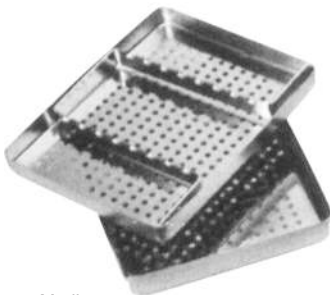
**MD-11-125** 288 x 187 x 40 mm



Maxi Set 3

Stainless Steel for 15 instruments

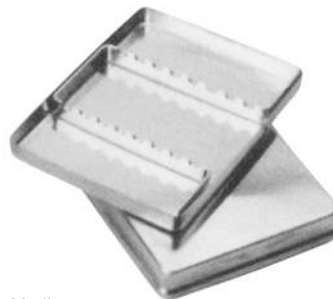
**MD-11-126** 288 x 187 x 40 mm



Medio

Stainless Steel Perforated Tray with cover

**MD-11-127** 187 x 145 x 25 mm



Medio

Stainless Steel Solid Tray with cover

**MD-11-128** 187 x 145 x 25 mm



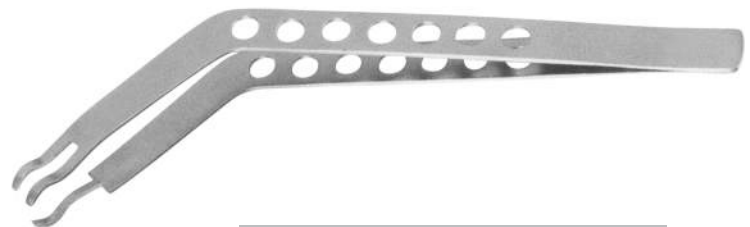
Burs Disinfecting Box Stainless Steel

**MD-11-129** 90 mm x 40 mm



Mesh Burs Holder

**MD-11-130** 35 mm x 150 mm



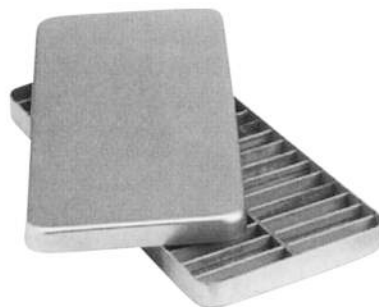
**MD-11-131** Bur Holding Tweezer 16.5 cm

## ENDODONTIC TRAYS & INSTRUMENTS



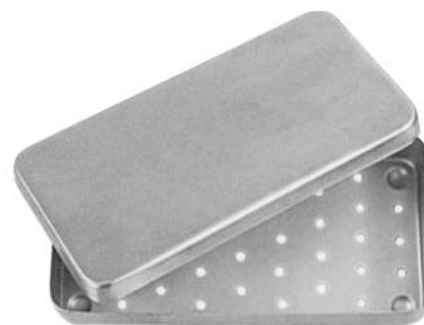
Perforated Instruments Boxes

MD-11-132	170 x 070 x 35 mm
MD-11-133	180 x 080 x 40 mm
MD-11-134	200 x 100 x 40 mm
MD-11-135	200 x 100 x 50 mm
MD-11-136	200 x 100 x 60 mm
MD-11-137	220 x 120 x 60 mm
MD-11-138	250 x 120 x 60 mm
MD-11-139	300 x 150 x 60 mm
MD-11-140	300 x 200 x 80 mm
MD-11-141	400 x 160 x 80 mm
MD-11-142	400 x 200 x 100 mm
MD-11-143	500 x 200 x 120 mm



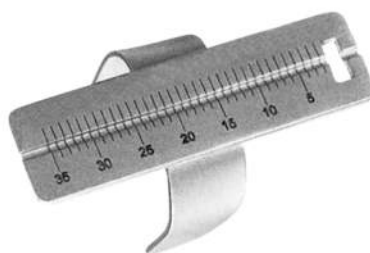
Stainless Steel endodontic tray with cover

MD-11-144 250 x 115 x 15 mm



Instrument Box perforated

MD-11-145 180 x 90 x 30 mm



MD-11-146 Endometer Laser etched



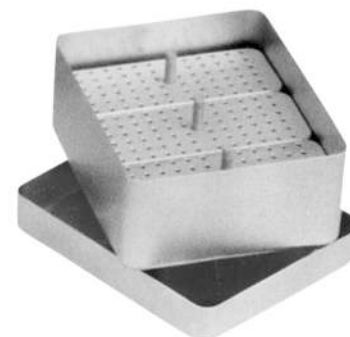
MD-11-147 Lester Pumice Cup



MD-11-148 Endo Box Round



MD-11-149 Endo Box



MD-11-150 Endo Box Trio



MD-11-151 Cotton Holder with Lid



MD-11-152 Cotton Holder without Lid



MD-11-153 Cotton Holder Estrella without Lid



## NEEDLE CASES, PETRI DISHES & FUNNELS



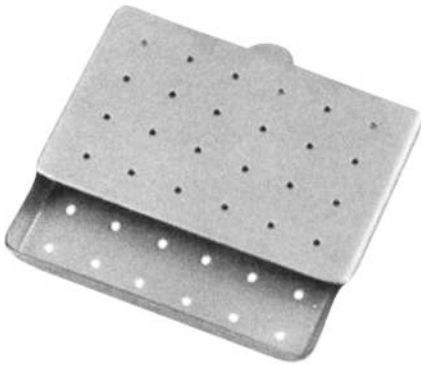
Needle Case	
<b>MD-11-154</b>	210 x 125 x 17 mm



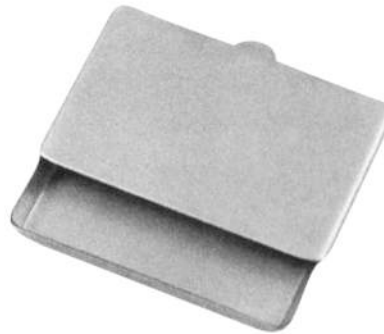
Needle Case Sauerbruch	
<b>MD-11-155</b>	210 x 125 x 17 mm



Needle Case	
<b>MD-11-156</b>	150 x 90 x 10 mm



Needle Cases Perforated	
<b>MD-11-157</b>	50 x 25 x 4.5 mm
<b>MD-11-158</b>	65 x 42 x 8 mm
<b>MD-11-159</b>	75 x 25 x 4.5 mm



Needle Cases Plain	
<b>MD-11-160</b>	50 x 25 x 4.5 mm
<b>MD-11-161</b>	65 x 42 x 8 mm
<b>MD-11-162</b>	75 x 25 x 4.5 mm



<b>MD-11-163</b>	Needle Case Complete
------------------	----------------------



Funnels	
	dia.
<b>MD-11-164</b>	100 mm
<b>MD-11-165</b>	120 mm
<b>MD-11-166</b>	150 mm
<b>MD-11-167</b>	200 mm
<b>MD-11-168</b>	240 mm



Petri Dishes	
	dia. height
<b>MD-11-169</b>	60 x 20 mm
<b>MD-11-170</b>	90 x 15 mm
<b>MD-11-171</b>	100 x 20 mm
<b>MD-11-172</b>	120 x 20 mm

## BOWLS & KIDNEY TRAYS



Gallipot	
	vol.
MD-11-173	50 ml
MD-11-174	100 ml
MD-11-175	150 ml
MD-11-176	225 ml



Stainless Steel Round Bowls			
	dia.	height	vol.
MD-11-177	Ø 40 mm	x 19 mm	0.05L
MD-11-178	Ø 60 mm	x 30 mm	0.07L
MD-11-179	Ø 80 mm	x 40 mm	0.14L
MD-11-180	Ø 100 mm	x 50 mm	0.35L
MD-11-181	Ø 120 mm	x 60 mm	0.45L
MD-11-182	Ø 150 mm	x 70 mm	0.70L
MD-11-183	Ø 180 mm	x 90 mm	1.10L
MD-11-184	Ø 200 mm	x 100 mm	1.60L



Stainless Steel Bowls			
	dia.	height	vol.
MD-11-185	Ø 40 mm	x 19 mm	0.05L
MD-11-186	Ø 60 mm	x 30 mm	0.07L
MD-11-187	Ø 80 mm	x 40 mm	0.14L
MD-11-188	Ø 100 mm	x 50 mm	0.35L
MD-11-189	Ø 120 mm	x 60 mm	0.45L
MD-11-190	Ø 150 mm	x 70 mm	0.70L
MD-11-191	Ø 180 mm	x 90 mm	1.10L
MD-11-192	Ø 200 mm	x 100 mm	1.60L



Wash Basins	
	dia.
MD-11-193	300 mm
MD-11-194	320 mm
MD-11-195	350 mm
MD-11-196	400 mm



Medicine Cup		
	dia.	height
MD-11-197	80 x 35 mm	
MD-11-198	125 x 60 mm	



Medicine Cup (Graduated)		
	Size ( mm )	Cap.( ml )
MD-11-199	2 Oz.	60 ml



Kidney Trays With LID	
	dia.
MD-11-200	150 mm
MD-11-201	200 mm
MD-11-202	250 mm
MD-11-203	300 mm



Kidney Trays	
	dia.
MD-11-204	150 mm
MD-11-205	200 mm
MD-11-206	250 mm
MD-11-207	300 mm



Kidney Trays Shallow	
	dia.
MD-11-208	150 mm
MD-11-209	200 mm
MD-11-210	250 mm
MD-11-211	300 mm



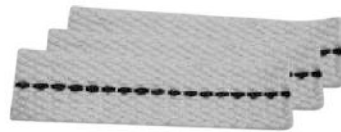
**MD-11-212** Spirit Lamp 120 cc



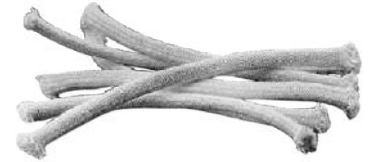
**MD-11-213** Spirit Lamp 120 cc



**MD-11-214** Spirit Lamp 120 cc



**MD-11-215** Spare wicks Flat 13 cm (pack of 5)



**MD-11-216** Spare wicks Round 13c m (pack of 5)



Forceps Jars

	dia.	height
<b>MD-11-217</b>	30	90 mm
<b>MD-11-218</b>	50	100 mm
<b>MD-11-219</b>	50	130 mm
<b>MD-11-220</b>	50	175 mm
<b>MD-11-221</b>	75	100 mm
<b>MD-11-222</b>	75	130 mm
<b>MD-11-223</b>	75	175 mm
<b>MD-11-224</b>	100	175 mm
<b>MD-11-225</b>	100	200 mm



Dressing Jars With Lid & Knob

	dia.	height
<b>MD-11-226</b>	75	60 mm
<b>MD-11-227</b>	75	75 mm
<b>MD-11-228</b>	100	60 mm
<b>MD-11-229</b>	100	100 mm
<b>MD-11-230</b>	125	80 mm
<b>MD-11-231</b>	125	125 mm
<b>MD-11-232</b>	150	150 mm



Dressing Jars / Cotton Containers

<b>MD-11-233</b>	80 x 60	mm
<b>MD-11-234</b>	80 x 80	mm
<b>MD-11-235</b>	100 x 60	mm
<b>MD-11-236</b>	100 x 80	mm
<b>MD-11-237</b>	100 x 100	mm
<b>MD-11-238</b>	120 x 80	mm
<b>MD-11-239</b>	120 x 100	mm
<b>MD-11-240</b>	120 x 120	mm
<b>MD-11-241</b>	150 x 100	mm
<b>MD-11-242</b>	150 x 150	mm
<b>MD-11-243</b>	180 x 150	mm
<b>MD-11-244</b>	180 x 180	mm
<b>MD-11-245</b>	200 x 200	mm
<b>MD-11-246</b>	240 x 240	mm

## MEASURING JUGS, BUCKETS & IRRIGATORS



Irrigators	
	vol.
<b>MD-11-247</b>	1.0L
<b>MD-11-248</b>	1.5L
<b>MD-11-249</b>	2.0L



Measuring Jugs	
	vol.
<b>MD-11-250</b>	250 ml
<b>MD-11-251</b>	500 ml
<b>MD-11-252</b>	1000 ml
<b>MD-11-253</b>	2000 ml



Measuring Jugs	
	vol.
<b>MD-11-254</b>	250 ml
<b>MD-11-255</b>	500 ml
<b>MD-11-256</b>	1000 ml
<b>MD-11-257</b>	2000 ml



Buckets With LID		Buckets Without LID	
	vol.		vol.
<b>MD-11-258</b>	8.0L	<b>MD-11-261</b>	8.0L
<b>MD-11-259</b>	10.0L	<b>MD-11-262</b>	10.0L
<b>MD-11-260</b>	15.0L	<b>MD-11-263</b>	15.0L



Sputum Cup	
	dia. height
<b>MD-11-264</b>	Ø 75 x 80 mm
<b>MD-11-265</b>	Ø 100 x 50 mm
<b>MD-11-266</b>	Ø 100 x 80 mm



Ointment Jar		
	dia. height	Vol.
<b>MD-11-267</b>	Ø 75 x 65 mm	250ml





## URINALS, BED PANS & STERILIZING DRUMS



Urinal Jugs		
MD-11-268	Horizontal	115 x 230 mm
MD-11-269	Vertical Junior	95 x 205 mm
MD-11-270	Vertical Adult	100 x 225 mm



**MD-11-271** Male Urinal



**MD-11-272** Urinal Female 1200 ml



Bed Pan	
	dia.
MD-11-273	235 mm
MD-11-274	320 mm



Bed Pan	
	dia.
MD-11-275	235 mm
MD-11-276	320 mm



**MD-11-277** Bed Pan



**MD-11-278** American Pattern Bed Pan Adult



Sterilizing Drums		
	dia.	height
MD-11-279	Ø 80	x 80 mm
MD-11-280	Ø 105	x 120 mm
MD-11-281	Ø 140	x 140 mm
MD-11-282	Ø 160	x 120 mm
MD-11-283	Ø 160	x 150 mm
MD-11-284	Ø 190	x 150 mm
MD-11-285	Ø 190	x 190 mm
MD-11-286	Ø 240	x 160 mm
MD-11-287	Ø 240	x 240 mm
MD-11-288	Ø 290	x 160 mm
MD-11-289	Ø 290	x 240 mm
MD-11-290	Ø 340	x 160 mm
MD-11-291	Ø 340	x 340 mm
MD-11-292	Ø 390	x 190 mm
MD-11-293	Ø 380	x 290 mm

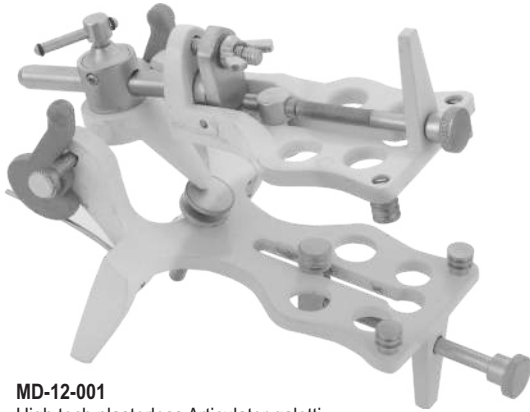
**MALLEABLE & DUCTILE**  
INSTRUMENTS

**12**

**Page 170-173**

Articulators





**MD-12-001**  
High tech plasterless Articulator galetti with adjustable screws at rears & front. All anatomical Movements Possible. Also available in vibratory polished



**MD-12-003**  
Semi anatomical silver Articulator high tech. Adjustable back rod by registration screw to work without incisal rod by keeping constant trajectories and inclinations during side and back/forward movements. Pure translation movement anti-shock hinge rod in case Articulator falls accidentally. Bigger size lock screws for mounting plates



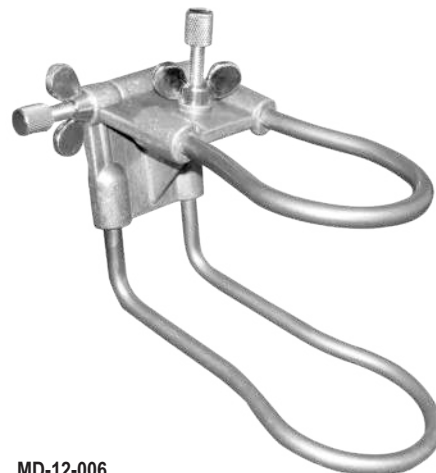
**MD-12-005**  
Magic Art-II Articulator high tech. Adjustable back lightweight, high-quality magic Art Articulator securely holds quadrant models, conserve materials & time! Quickly & Easily mouth pre-cast dental models with the high quality



**MD-12-002**  
Pro Tamahachi Articulator Standard arcon yamahachi type Articulator with A ball slot type path on the maxillary frame



**MD-12-004**  
Gnatus Pro Jp30 Articulator best performance with an excellent degree of accuracy. Its functionality makes easier both the procedures of taking & transferring the patient's records & the process of mounting the models



**MD-12-006**  
Vibratory polished wire Articulator - Made of stainless steel & die cast aluminum

ARTICULATORS



**MD-12-007**  
 Articulator ASA W/out bearing rod.  
 Anatomical articulator with incisive pin.  
 4 mounting plates and Supporting back pin.  
 Available in assorted colors



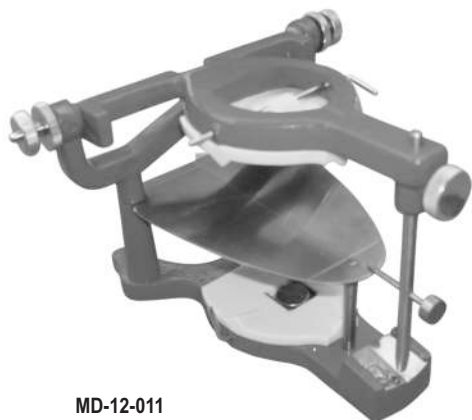
**MD-12-008**  
 ASA Articulator with lateral moment.  
 Made of aluminum die casting with  
 2 Mounting Plates. Also Available in  
 vibratory polished process & Assorted colors



**MD-12-009**  
 Keystone deluxe magnetic denture  
 articulator with plates, Interchangeable,  
 Incisal pin Included. Magnetic Split Casting  
 ensures Easy & Exact Setting, Lateral  
 excursions



**MD-12-010**  
 Keystone deluxe universal type-A Articulator.  
 Interchangeable, Included Incisal pin, Lateral  
 excursions



**MD-12-011**  
 Anatomical Articulator Universal,  
 Realized for easy visibility to the lingual surface  
 & for A perfect stability Also In reserved position.  
 (Also available in assorted colors)



**MD-12-012**  
 Chromium plated fork  
 Fork Crowned Bridge.  
 Nickle chromium plated articulator



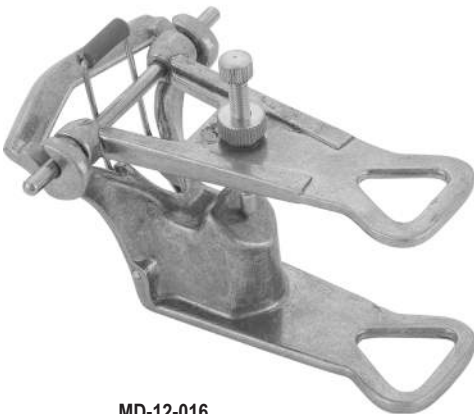
**MD-12-013**  
Full arch hinged articulator  
chromium plated hinge articulator  
for mounting full arch cases.  
Low back gypsum-free articulation enables  
clean & accurate mounting & dismounting  
in 30 seconds



**MD-12-014**  
Ray foster 57 chrome articulator  
chrome brass hinge crowned bridge  
articulator for mounting quadrant cases.  
Crown & bridge articulator is popular ray  
foster # 57 design,  
eliminates the need to break off models



**MD-12-015**  
Occlusor, wire articulator,  
Available in 2 sizes,  
Small & Large



**MD-12-016**  
Professional occlusor.  
Vibratory polished articulator.



**MD-12-017**  
Dental articulator 2x-cresant brand  
full denture chromium plated articulator.  
Provides additional vertical dimension for  
acceptance of higher models. 49 wide at  
the joint & has a vertical span between  
parallel bows of 25/8"



**MD-12-018**  
Hinge articulator full arch  
plain line nickle chromium  
plated articulator



**MD-12-019**  
Magic Art-I articulator lightweight



**MD-12-020**  
Mortimer-I occluder articulator  
All filled with high carbon Steel balls.  
Also available in gold plated



**MD-12-021**  
Mortimer-II occluder articulator  
Also available in gold plated

British Pattern



# DENTAL Instruments Catalogue

- Basic Orthopedic Instruments ■
- Spinal Instruments ■
- Trauma Instruments ■



📍 Ward # 4, Masjid Road, Saddar Bazar, Sialkot Cantt Pakistan

☎ +92-311-7786276    📞 +92-322-9284144    📞 +92-52-4268308

✉ info@mndinstruments.com

🌐 www.mndinstruments.com

